Nuclear Plant Journal

*An International Publication
Published in the United States*

*Product & Service
Directory—2013*

**November-December, 2012
Volume 30 No. 6**



Arkansas Nuclear One, United States

ISSN: 2162-6413

FIELD REPORT#4

Topic	Outage Excellence
Location	USA

It's also what happens between outages that determines outage excellence.

Utilities can be confident they'll meet their outage goals during and between outages, thanks to AREVA's experience feedback from conducting more than 110 outages a year on nearly all types of reactors worldwide. AREVA's highly skilled teams deploy proven, innovative technologies and solutions backed by service-proven knowledge of utilities' objectives for reactor maintenance and fuel reloading operations.

As an example, one of the utilities' needs is to reduce the deposit inventory on the steam generators. To support them, AREVA has developed an innovative solution: Deposit Minimization Treatment (DMT), a fast, environmentally-friendly and effective process. This process improves personnel safety during outages, provides additional operating margin and saves processing costs for the plant. Find out how AREVA's investments in facilities, processes and people are helping utilities tackle increasingly complex outage projects safely and economically as measured by plant performance long after the outage is over.

Return on Experience

**ENHANCED SAFETY
AND PROFITABILITY**

forward-looking energy

Find out why: www.aveva.com/fieldreport

A
AREVA

YOU NEED A COMPANY WITH PROVEN NUCLEAR EXPERIENCE



WITH MORE THAN 10,000 NUCLEAR CONTROL LOOPS
IN OPERATION OF OUR NRC-APPROVED HFC-6000 PLATFORM

YOU NEED A SYSTEM APPROVED AROUND THE WORLD



FROM TOTAL PLANT CONTROLS TO EDG CONTROLS YOU CAN BE
CONFIDENT THAT HF CONTROLS CAN DELIVER COST-EFFECTIVE SYSTEMS

YOU NEED HFC-6000

CALL US TO SEE HOW WE CAN BE YOUR PARTNER
IN YOUR JOURNEY OF I&C EXCELLENCE



HF CONTROLS

A **DOOSAN** COMPANY

1-866-501-9954

WWW.HFCONTROLS.COM



SCAN QR CODE WITH YOUR
SMARTPHONE FOR MORE INFO

YOUR BURIED PIPING INSPECTION SOLUTION

Have Diakont perform in-line inspection of your plant's buried piping, and meet your NEI 09-14 obligations



Inspection without Excavation

Diakont's inspection teams use self-propelled robots to overcome buried pipe NDE challenges:

- 100% non-contact internal ultrasonic inspection of 16"-54" pipes, using patented EMAT technology
- High-precision detection and measurement of indications
- Graphical reporting and integration with BPWorks database
- Robots capable of navigating elbows and vertical pipe sections

Call Diakont today to receive information on the industry's only comprehensive nuclear buried pipe inspection solution. *Some Spring 2013 inspection availability remaining.*



DIAKONT SPECIALIZES IN...

- Rad-Tolerant Cameras and CCTV Systems
- Custom Robotics
- Nuclear I&C Systems
- Fuel Handling Equipment
- Buried Pipe Inspection

Nuclear Plant Journal

Product & Service Directory—2013

Now in its 30th Year of Publication



Table of Contents

November-December 2012
Volume 30 No. 6

www.NuclearPlantJournal.com

- List of Advertisers6
- Directory Directions8
- Products and Services10
- Corporate Capabilities86
- Corporate Capabilities Participants...100
- Suppliers102
- ANO Plant Profile.....112

Journal Services

- 2014 Directory 21
- 2013 Editorial Schedule 44
- Web Directory..... 101

The Cover

In 2001, the NRC granted a 20-year license renewal to Arkansas Nuclear One, Unit 1, positioning Entergy as an industry frontrunner in license renewal and setting the pace for additional renewal efforts. The expiration date is May 2034. See a profile on page 112.

Mailing Identification Statement

Nuclear Plant Journal (ISSN 0892-2055) is published bimonthly in February, April, June, August, October and December by EQES, Inc., 1400 Opus Place, Suite 904, Downers Grove, IL 60515. The printed version of the Journal is available cost-free to qualified readers in the United States and Canada. The digital version is available cost-free to qualified readers worldwide. The subscription rate for non-qualified readers is \$150.00 per year. The cost for non-qualified, non-U.S. readers is \$180.00. Periodicals (permit number 000-739) postage paid at the Downers Grove, IL 60515, USA and additional mailing offices. POSTMASTER: Send address changes to *Nuclear Plant Journal* (EQES, Inc.), 1400 Opus Place, Suite 904, Downers Grove, IL 60515, USA. Phone: (630) 858-6161 x103, Fax: (630) 852-8787, e-mail: michelle@goinfo.com.

Circulation Statistics

Total:	12,000
Utilities:	2,476

© Copyright 2012 by EQES, Inc.
Nuclear Plant Journal is a registered trademark of EQES, Inc. Printed in USA.

Staff

- Senior Publisher & Editor*
Newal K. Agnihotri
- Publisher & Sales Manager*
Anu Agnihotri
- Assistant Editor & Marketing Manager*
Michelle Gaylord
- Administrative Assistant*
QingQing Zhu



List of Advertisers

Page Advertiser

41	AAF
45	Aerofin Corporation
29	American Crane & Equipment Corporation
2	AREVA NP, Inc.
8	AT&F Nuclear, Inc
9	AZZ Incorporated
33	Bechtel Power
99	Bigge Power Constructors
51	Birns
81	Cameco Fuel Manufacturing
67	Candu Energy, Inc.
58	Ceradyne Boron Products
73	Chatham Steel Corporation
83	Copes-Vulcan, An SPX Brand
53	Day & Zimmermann ECM
4	Diakont
47	Ellis & Watts Global Industries, LLC
13	Energy Steel & Supply Company
116	EST Group, a business unit of Curtiss-Wright Flow Control Company
35	Fairbanks Morse Engine
22	Fauske & Associates, LLC
19	Frham Safety Products, Inc.
71	Frontier Technology Corporation
72	G. D. Barri & Associates, Inc.
25	GE Hitachi Nuclear Energy
59	GE Hitachi Nuclear Energy
50	Herguth Laboratories, Inc.
3	HF Controls
41	Hi-Q Environmental Products Company
12	Hukari Ascendent

Page Advertiser

37	Joseph Oat Corporation
7	Kinectrics Inc.
17	Mirion Technologies, Inc.
44	Mohawk Industrial & Nuclear Supply, Inc.
23	NUCON International, Inc.
27	Oregon Iron Works, Inc.
74	Performance Contracting Inc. (PCI)
49	Rolls-Royce
57	Schulz Electric Company
69	Scientech, a business unit of Curtiss-Wright Flow Control Company
69	Seal Master
31	Siempelkamp Nukleartechnik GmbH
46	SSM Industries, Inc.
78	Structural Integrity Associates, Inc.
85	Technology for Energy Corporation (TEC)
70	tecnatom, s.a.
61	The Shaw Group Inc., Nuclear Power Division
77	Thermo Scientific- CIDTEC
15	TPC Wire & Cable
62	Tri Tool Inc.
40	Trust Manufacturing
55	TW Metals- Nuclear Materials Solutions
18	UniTech Services Group
32	UniTech Services Group
39	URENCO Ltd.
84	Weldstar
75	Westerman Nuclear
115	Westinghouse Electric Company LLC
11	Zachry Nuclear Engineering, Inc

All advertiser web sites are listed on page 101. Complete advertiser contact information, including e-mail and web site addresses, is also provided in the Suppliers section starting on page 102.



GENERATING SUCCESS—FOR 100 YEARS

Kinectrics is celebrating 100 years of success in providing advanced technical expertise to the electricity generation industry.

For nuclear, our unique engineering and testing capabilities include complete outage support, inspection and equipment qualification, nuclear plant chemistry and many other industry-accredited services.

- Life Cycle Management and Plant Life Extension
- Genuine Nuclear Parts and Equipment Qualification
- Inspection and Maintenance Systems and Services
- Materials Characterization and Forensic Analysis
- Plant Chemistry and Nuclear Waste Management
- Regulatory Affairs and Licensing



KINETRICS*US



kinectrics.com

kinectrics.us

axiomndt.com

candesco.com

Directory Directions

Features

The Directory is a source of information on resources for over 3,000 products and services related to the nuclear power industry. The information included in the Directory was submitted by 270 suppliers worldwide.

The Products & Services section includes listings of available current products and services with the names of the related suppliers. Items listed in the Directory are related to the nuclear power industry only. Therefore, the words “nuclear” or “nuclear power” have been dropped from certain product and service terms.

The modified noun approach has been used for several terms. For example, Corrosion Monitoring Software has been listed as “Software: Corrosion Monitoring.” “Airborne Radioactivity Monitoring Systems” has been listed

as “Monitoring Systems: Airborne Radioactivity.”

Each supplier’s listing in the Suppliers section includes complete contact information.

Telephone numbers outside of the United States are listed as submitted by the Directory participants. The caller may need to add the proper country and city codes to make the telephone or fax number complete.

The bullets before individual suppliers in the Products & Services section, Corporate Capabilities Section, and in the Suppliers section denote an advertiser in the Directory. The page number of each advertisement is shown in the List of Advertisers on Page 6 and also in the Suppliers section immediately following the supplier’s contact information.

Corporate Capabilities

The Corporate Capabilities section lists products and services of organizations in one central location. Supplier contact information is also provided in this section. A “\$” symbol before the contact information in the Suppliers section indicates that the organization has a listing in the Corporate Capabilities section. The related page number where the Corporate Capabilities is provided is included after each supplier’s contact information. A list of Corporate Capabilities participants is provided on page 100.

Phone: (630) 858-6161, ext. 103

Fax: (630) 852-8787

E-mail: michelle@goinfo.com

Web Site: www.NuclearPlantJournal.com



Now with the biggest roll in the western hemisphere — up to 12 inches thick and up to 14 feet wide — there’s no reason to go anywhere other than AT&F Nuclear to roll “forging quality plate.” With access to prime materials direct from the mill, AT&F Nuclear provides a complete range of nuclear components and complex build-to-print fabrications for new builds, SMRs and nuclear waste containers. Our nuclear industry experience and rolling capabilities provide high quality, tight tolerance fabrications reducing dependence on long lead forgings.

Experience 70+ Years of Reliable Quality.



800-544-5316 • www.atfnuclear.com

WE INVEST IN CUSTOMER SUCCESS™

There's no substitute for a finely tuned instrument.

**The operator's credo:
always trust your instrumentation.**

Trust is a lot easier when you have the very best. That's why NLI has partnered with some of the best names in the instrumentation business, such as Ametek, Ashcroft, Krohne, and OTEK. We also offer reverse engineered solutions to legacy instrumentation challenges, such as obsolete power supplies.



OTEK Digital Bargraph Meter



Krohne Altonsonic Flowmeter



Ashcroft Differential Pressure Transmitter

Whatever your needs, NLI provides a full range of instrumentation offering unparalleled accuracy and reliability.

Call NLI. We're your single source.



Products & Services

3D Laser Scanning of Facilities

- Candu Energy Inc

Absorbents

- Frham Safety Products, Inc.
- JRM Chemical, Inc.

Absorbers

- JRM Chemical, Inc.

Absorbers: Charcoal

- Ellis & Watts Global Industries, LLC.

Accelerometers

- C.J. Enterprises

Access Control Systems

- Mirion Technologies

Access Processing Software

- Sciencetech, a business unit of Curtiss-Wright
- Flow Control Company

Accumulators

- AZZ / NLI
- Energy Steel & Supply CO.
- Joseph Oat Corporation
- Precision Custom Components, LLC

Actuators

- AZZ / NLI
- Copes-Vulcan, SPX Brand
- Enertech, a business unit of Curtiss-Wright
- Flow Control Company
- Seal Master Corporation
- SSM Industries, Inc.
- WITTENSTEIN

Adsorbents: Radioiodine

- NUCON International, Inc.

Adsorbents: Radioiodine, Laboratory Testing

- NUCON International, Inc.

Adsorber Cells: Charcoal

- AAF International
- Ionex Research Corp.
- NUCON International, Inc.

Adsorbents

- AAF International
- NUCON International, Inc.

Aerosol Testing Materials

- Gammasonics Institute for Medical Research
- NUCON International, Inc.

Aerosols

- NUCON International, Inc.

Agging Management

- Structural Integrity Associates, Inc.

Air Balancing

- NUCON International, Inc.

Air Conditioning: Packaged

- AZZ / NLI
- Ellis & Watts Global Industries, LLC.
- SSM Industries, Inc.

Air Conditioning: Split

- AZZ / NLI
- Ellis & Watts Global Industries, LLC.
- SSM Industries, Inc.

Air Dryers

- AZZ / NLI
- Frham Safety Products, Inc.

Air Filtration Units

- AAF International
- AZZ / NLI
- BHI Energy
- Ellis & Watts Global Industries, LLC.
- Ionex Research Corp.

- NUCON International, Inc.
- SSM Industries, Inc.

Air Handling Units

- AAF International
- AZZ / NLI
- Ellis & Watts Global Industries, LLC.
- Frham Safety Products, Inc.
- SSM Industries, Inc.

Air Lock Services

- Seal Master Corporation

Air Management

- Golder Associates Ltd.

Air Monitoring Systems: Containment

- Apantec LLC, North Penn Business Parrk

Air Samplers

- Draeger Safety, Inc.
- F+J Specialty Products, Inc.
- Frham Safety Products, Inc.
- Gammasonics Institute for Medical Research
- HI-Q Environmental Products Company
- Mirion Technologies
- Staplex-Air Sampler Division

Air Samplers: Personal

- F+J Specialty Products, Inc.
- Frham Safety Products, Inc.
- HI-Q Environmental Products Company

Air Sampling Systems

- F+J Specialty Products, Inc.
- Frham Safety Products, Inc.
- HI-Q Environmental Products Company
- Mirion Technologies

Air-Operated Valve Diagnostics

- BHI Energy
- Enertech, a business unit of Curtiss-Wright
- Flow Control Company

ALARA Management Services

- BHI Energy
- WMG, Inc.

Alarm Monitoring Panels

- AZZ / NLI

Alarm Monitoring System

- AZZ / NLI
- Gammasonics Institute for Medical Research
- Mirion Technologies
- Sciencetech, a business unit of Curtiss-Wright
- Flow Control Company

Alarm System Sensors

- Pressure Controls, Inc.

Alarms: Dose

- Mirion Technologies

Alarms: Electronic Modules

- Acromag, Inc.
- Sciencetech, a business unit of Curtiss-Wright
- Flow Control Company

Alarms: Rate

- Mirion Technologies

Alarms: Safety-Related

- Aware Electronics Corp.
- Mirion Technologies
- Nutherm International, Inc.
- Sciencetech, a business unit of Curtiss-Wright
- Flow Control Company

Ammeters

- Nutherm International, Inc.

Analysis: 10 CFR 61 Compliance

- Eberline Services Inc.

Analysis: Bioassay

- Eberline Services Inc.

Analysis: Chemical

- Fauske & Associates., LLC
- Herguth Laboratories
- Kinectrics Incorporated

Analysis: Criticality

- CTR Technical Services, Inc.
- HukariAscendent
- Joseph Oat Corporation
- Sciencetech, a business unit of Curtiss-Wright
- Flow Control Company
- Siempelkamp Nukleartechnik GmbH

Analysis: Dynamic

- AZZ / NLI
- Fauske & Associates., LLC
- Sargent & Lundy

Analysis: Engineering

- American Crane & Equipment Corp.
- Bechtel Power
- Candu Energy Inc
- CTR Technical Services, Inc.
- DCS Systems Inc.
- Energy Steel & Supply CO.
- Fauske & Associates., LLC
- HukariAscendent
- Joseph Oat Corporation
- Rolls-Royce
- Sargent & Lundy
- Siempelkamp Nukleartechnik GmbH
- Structural Integrity Associates, Inc.
- Tecnatom, S.A.
- URS Corporation
- Zachry Nuclear Engineering, Inc

Analysis: Environmental

- AZZ / NLI
- Eberline Services Inc.
- HukariAscendent
- S.M. Stoller Corp.
- Sargent & Lundy

Analysis: Finite Element

- AZZ / NLI
- Design Engineering Analysis Corporation
- Energy Steel & Supply CO.
- Fauske & Associates., LLC
- Novatech
- Sciencetech, a business unit of Curtiss-Wright
- Flow Control Company
- Siempelkamp Nukleartechnik GmbH
- Structural Integrity Associates, Inc.
- Zachry Nuclear Engineering, Inc

Analysis: Heat Transfer

- Bechtel Power
- Conco Systems, Inc.
- Energy Steel & Supply CO.
- Fauske & Associates., LLC
- Joseph Oat Corporation
- Novatech
- Red Wolf Associates
- Rolls-Royce
- Zachry Nuclear Engineering, Inc

Analysis: Hydraulic

- Bechtel Power
- Fauske & Associates., LLC
- Red Wolf Associates
- Rolls-Royce
- Sargent & Lundy
- Zachry Nuclear Engineering, Inc

Analysis: Material Identification

- HukariAscendent
- Kinectrics Incorporated
- M+P Lab
- Trust Manufacturing

Just think of us

as part of your



NO MATTER WHAT PLAY
YOU'RE CALLING,
OFFENSE OR DEFENSE—
COUNT ON ZACHRY
FOR
PERFECT EXECUTION

WHEN IT MATTERS MOST. . .



Who would you want to be tied to?



HukariAscendent

Supporting the Nuclear Science and Technology Industry in:

- *Engineering*
- *Nuclear Safety Analysis*
- *Licensing*
- *Quality Assurance*
- *Project Management*
- *And many related technical disciplines.*

303-384-9079
www.hukari.com

HukariAscendent is a Service-Disabled Veteran-Owned Small Business

*Please email your resume to: resumes@hukari.com
In addition, please submit the on-line application at:
www.hukari.com*

Analysis: Mixed Waste

- Eberline Services Inc.
- HukariAscendent
- Kinectrics Incorporated

Analysis: Modal

- Fauske & Associates., LLC

Analysis: Neutron Activity

- Gammasonics Institute for Medical Research
- Mirion Technologies
- Siempelkamp Nukleartechnik GmbH
- TransWare Enterprises Inc.

Analysis: Polymer

- Kinectrics Incorporated

Analysis: Project

- HukariAscendent

Analysis: Radioactive Gas

- Gammasonics Institute for Medical Research
- Kinectrics Incorporated
- NUCON International, Inc.

Analysis: Reactor Physics

- Candu Energy Inc
- CTR Technical Services, Inc.
- DCS Systems Inc.
- Fauske & Associates., LLC
- Siempelkamp Nukleartechnik GmbH
- TransWare Enterprises Inc.

Analysis: Reliability

- Atlantic Nuclear Services Inc.
- Candu Energy Inc
- CORE, Inc.
- Fauske & Associates., LLC
- HukariAscendent
- S.M. Stoller Corp.
- Sargent & Lundy
- Scientech, a business unit of Curtiss-Wright
- Flow Control Company

Analysis: Risk

- Atlantic Nuclear Services Inc.
- CORE, Inc.
- Diakont
- Fauske & Associates., LLC
- HukariAscendent
- Rolls-Royce
- Sargent & Lundy
- Scientech, a business unit of Curtiss-Wright
- Flow Control Company
- Structural Integrity Associates, Inc.

Analysis: Root Cause

- DCS Systems Inc.
- DCS Systems Inc.
- Fauske & Associates., LLC
- Herguth Laboratories
- HukariAscendent
- Kinectrics Incorporated
- Rolls-Royce
- Sargent & Lundy
- Southwest Research Institute
- Structural Integrity Associates, Inc.
- Wyle Laboratories, Inc.
- Zachry Nuclear Engineering, Inc

Analysis: Safety

- Atlantic Nuclear Services Inc.
- CTR Technical Services, Inc.
- Diakont
- Fauske & Associates., LLC
- HukariAscendent
- Rolls-Royce
- Scientech, a business unit of Curtiss-Wright
- Flow Control Company
- Siempelkamp Nukleartechnik GmbH
- VGSSolutions
- VTT Technical Research Centre of Finland
- Zachry Nuclear Engineering, Inc

Analysis: Severe Accident

- Bechtel Power
- Fauske & Associates., LLC
- Sargent & Lundy

- Scientech, a business unit of Curtiss-Wright
- Flow Control Company
- Siempelkamp Nukleartechnik GmbH

Analysis: Static

- Candu Energy Inc

Analysis: Stress

- Bechtel Power
- Candu Energy Inc
- Fauske & Associates., LLC
- Sargent & Lundy
- Siempelkamp Nukleartechnik GmbH
- Structural Integrity Associates, Inc.
- Zachry Nuclear Engineering, Inc

Analysis: Structural

- American Crane & Equipment Corp.
- Bechtel Power
- Candu Energy Inc
- Fauske & Associates., LLC
- HukariAscendent
- Sargent & Lundy
- Structural Integrity Associates, Inc.
- Zachry Nuclear Engineering, Inc

Analysis: Support

- Fauske & Associates., LLC
- Zachry Nuclear Engineering, Inc

Analysis: Thermal

- Candu Energy Inc
- Fauske & Associates., LLC
- Joseph Oat Corporation
- Red Wolf Associates
- Sargent & Lundy
- Siempelkamp Nukleartechnik GmbH
- Structural Integrity Associates, Inc.
- Zachry Nuclear Engineering, Inc

Analysis: Vibration

- Fauske & Associates., LLC
- Joseph Oat Corporation
- Ludeca Inc.
- Schulz Electric Company
- Structural Integrity Associates, Inc.
- Wyle Laboratories, Inc.
- Zachry Nuclear Engineering, Inc

Analysis: Waste

- Eberline Services Inc.
- HukariAscendent
- Sargent & Lundy

Analytical Services

- Diakont
- Kinectrics Incorporated
- Structural Integrity Associates, Inc.

Analzers: Data: Portable Online

- Gammasonics Institute for Medical Research

Analzers: Multichannel

- Biodex Medical Systems, Inc.
- Gammasonics Institute for Medical Research
- Mirion Technologies

Analzers: Trace Oxygen

- Chemetrics, Inc.

Annunciators

- AZZ / NLI

Anti-friction Bearings: Safety-Related

- Schulz Electric Company

Aprons: Lead

- Frham Safety Products, Inc.
- Gammasonics Institute for Medical Research

Asbestos Abatement Services

- Fuel Tank Maintenance Company LLC

ASME Certificate Holder

- AT&F Nuclear, Inc, Division of AT & F
- AZZ / NLI
- Copes-Vulcan,SPX Brand
- Ellis & Watts Global Industries, LLC.
- Energy Steel & Supply CO.
- Enertech, a business unit of Curtiss-Wright
- Flow Control Company
- Joseph Oat Corporation

CAPABLE AND QUALIFIED

Energy Steel & Supply Co. maintains the most stringent accreditations. Our Nuclear Quality Assurance program ensures that every product is manufactured and verified to meet or exceed expectations. When time is of the essence and there is no room for error, customers call on Energy Steel for its diverse scope of supply and the flexibility to react and adapt to the critical demands of our industry.

ENGINEERED TO SERVE

Nuclear is our only business. Our Design Engineering, Material Supply, Precision Machining, and Welded Fabrication operations are dedicated to providing unique and creative solutions specifically for the commercial nuclear industry. Our clients know that if it's physically possible we can make it happen and will do whatever it takes. We are here to serve.

IN PARTNERSHIP

We provide a solution to obsolescence. Through a network of exclusive and strategic partnerships with original manufacturers, Energy Steel & Supply Co. can continue the legacy supply of their "Original Equipment". We are in communication with the original manufacturers and have access to original design information; promising true "like for like" original product manufacturing.



energysteel

ENERGY STEEL & SUPPLY CO.

3123 JOHN CONLEY DRIVE : LAPEER, MICHIGAN 48446

PHONE (810) 538-4990 : FAX (810) 538-4940

www.ENERGYSTEEL.com

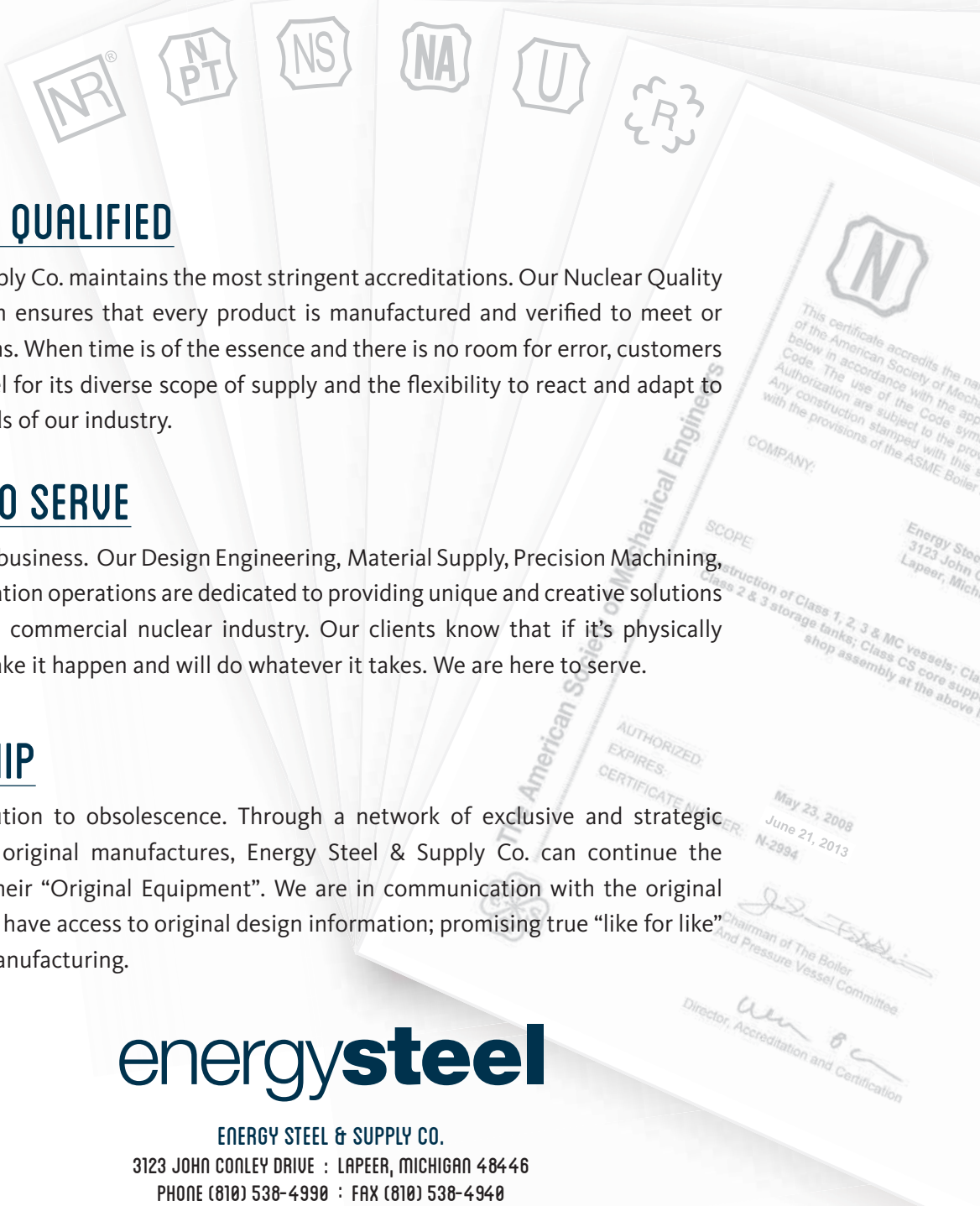

- NUCON International, Inc.
 - Oregon Iron Works, Inc
 - Precision Custom Components, LLC
 - Rolls-Royce
 - Siempelkamp Nukleartechnik GmbH
 - Teledyne Brown Engineering, Inc.
 - Tioga Pipe Supply Company Inc.
 - TW Metals - Nuclear Materials Solutions
 - Valcor Engineering Corporation
 - Westerman Nuclear
- Assemblies: Electrical**
- AZZ / NLI
 - Nutherm International, Inc.
 - Rolls-Royce
- Assemblies: Printed Circuit**
- AZZ / NLI
 - Sciencetech, a business unit of Curtiss-Wright
 - Flow Control Company
- Assessment Centers**
- HukariAscendent
- Assessment: Plant Condition**
- Black & Veatch
 - Dynasil Products
 - HukariAscendent
 - Sargent & Lundy
 - Structural Integrity Associates, Inc.
- Assessments: Operations Experience**
- HukariAscendent
- Assessments: Program**
- Black & Veatch
 - HukariAscendent
 - Human and Organizational Performance
 - Improvement
- Asset Tracking Systems**
- Black & Veatch
- Audit**
- Black & Veatch
 - HukariAscendent
 - Theseus Professional Services, LLC
- Audit Support: Program**
- DCS Systems Inc.
 - HukariAscendent
- Audit Support: Technical Specialist**
- DCS Systems Inc.
 - HukariAscendent
 - Sargent & Lundy
- Auditing: Environmental**
- HukariAscendent
 - S.M. Stoller Corp.
- Audits: Health Physics**
- Bevelacqua Resources
- Audits: Quality**
- DCS Systems Inc.
 - HukariAscendent
 - National Inspection & Consultants, LLC.
 - Preferred Quality Services, Inc.
 - S.M. Stoller Corp.
 - Sargent & Lundy
- Audits: Water Quality**
- Golder Associates Ltd.
- Availability Improvements**
- Black & Veatch
 - Sargent & Lundy
- Babbitt Bearing: Repair, Safety-Related**
- Enertech, a business unit of Curtiss-Wright
 - Flow Control Company
 - Fusion Babbiting Co. Inc
 - Schulz Electric Company
- Bags**
- Euclid Garment Manufacturing Company
 - Frham Safety Products, Inc.
 - LANCS Industries Holdings, LLC.
 - Reef Industries, Inc.
 - Seal Master Corporation
 - UniTech Services Group, Inc., Div. of Unifirst Corp.

- Bags: Asbestos**
- Reef Industries, Inc.
- Bags: Laundry**
- Euclid Garment Manufacturing Company
 - Frham Safety Products, Inc.
 - LANCS Industries Holdings, LLC.
 - UniTech Services Group, Inc., Div. of Unifirst Corp.
- Balancing**
- Energy Resources Group, Inc.
 - Ludeca Inc.
 - Schulz Electric Company
- Bargraphs: Class 1E**
- Nutherm International, Inc.
- Barriers: Clear Lead (Shielding)**
- Biodex Medical Systems, Inc.
- Barriers: Clear Lead Mobile**
- Biodex Medical Systems, Inc.
- Barriers: Lead**
- Biodex Medical Systems, Inc.
 - Frham Safety Products, Inc.
 - LANCS Industries Holdings, LLC.
- Barriers: Security**
- Black & Veatch
 - Dufrane Nuclear Shielding, Inc.
- Battery Charger Maintenance**
- Enersys
- Battery Chargers**
- AZZ / NLI
 - Black & Veatch
 - Enersys
 - GUTOR Electronic LLC
 - Nutherm International, Inc.
 - Sciencetech, a business unit of Curtiss-Wright
 - Flow Control Company
- Battery Test Equipment**
- Enersys
 - GUTOR Electronic LLC
- Bearings: Babbitted**
- Fusion Babbiting Co. Inc
- Bearings: Babbitted, Repair**
- Fusion Babbiting Co. Inc
 - Schulz Electric Company
- Bellows: Metallic**
- VAT, INC.
- Bills of Material Development**
- Black & Veatch
- Blanket Racks**
- Dufrane Nuclear Shielding, Inc.
 - LANCS Industries Holdings, LLC.
- Blankets: Lead**
- Frham Safety Products, Inc.
 - LANCS Industries Holdings, LLC.
- Blocks/Bricks: High-Density Concrete**
- Dufrane Nuclear Shielding, Inc.
 - Nuclear Shielding Supplies & Service
- Blocks/Bricks: Lead**
- Biodex Medical Systems, Inc.
 - LANCS Industries Holdings, LLC.
- Blowers: Ventilation**
- SSM Industries, Inc.
- Boilermaking**
- Joseph Oat Corporation
- Boilers**
- Joseph Oat Corporation
 - Structural Integrity Associates, Inc.
- Bolt Heaters**
- Energy Steel & Supply CO.
- Bolt Hole Maintenance**
- Siempelkamp Nukleartechnik GmbH

- Bolt Tensioning Systems**
- Hydratight
 - Siempelkamp Nukleartechnik GmbH
 - Trust Manufacturing
- Bolt Tensioning: Precision**
- Siempelkamp Nukleartechnik GmbH
 - Trust Manufacturing
- Bolt Tightening: Ultrasonic**
- Trust Manufacturing
- Bolting Services**
- Siempelkamp Nukleartechnik GmbH
 - Trust Manufacturing
- Bolts**
- Energy Steel & Supply CO.
 - Joseph Oat Corporation
 - Niagara Fasteners Inc.
 - Superbolt Inc.
 - Trust Manufacturing
 - TW Metals - Nuclear Materials Solutions
- Bolts: Anchor**
- Energy Steel & Supply CO.
 - Niagara Fasteners Inc.
 - Trust Manufacturing
 - TW Metals - Nuclear Materials Solutions
- Boric Acid Recovery**
- Diversified Technologies Services, Inc.
- Boron Carbide**
- Ceradyne Boron Products
 - Mass Spec Services
 - Nuclear Shielding Supplies & Service
- Boron-10: Enriched**
- Ceradyne Boron Products
 - Mass Spec Services
- Boron-11: Enriched**
- Ceradyne Boron Products
 - Mass Spec Services
- BWR Control Rod Drives**
- GE Hitachi Nuclear Energy
- BWR Control Rods**
- GE Hitachi Nuclear Energy
- BWR Fuel**
- GE Hitachi Nuclear Energy
- BWR Fuel Design and Analysis**
- GE Hitachi Nuclear Energy
- BWR Fuel Inspection**
- GE Hitachi Nuclear Energy
- BWR Inspection Services**
- GE Hitachi Nuclear Energy
- BWR Nuclear Analysis**
- GE Hitachi Nuclear Energy
- BWR Plant Performance Improvements**
- GE Hitachi Nuclear Energy
- BWR Radiological Analysis**
- GE Hitachi Nuclear Energy
 - WMG, Inc.
- BWR Reactor Internals Design and Repair**
- GE Hitachi Nuclear Energy
- BWR Reactor Services**
- GE Hitachi Nuclear Energy
- BWR Water Chemistry Consulting**
- GE Hitachi Nuclear Energy
- BWR Water Chemistry Services**
- GE Hitachi Nuclear Energy
- Cabinets: Shielded**
- Biodex Medical Systems, Inc.
 - Container Products Corporation
 - Dufrane Nuclear Shielding, Inc.
 - Gammasonics Institute for Medical Research
 - LANCS Industries Holdings, LLC.
 - Rolls-Royce

Cable Assemblies

- AZZ / NLI
- Black & Veatch
- Mirion Technologies
- Rolls-Royce
- Scientech, a business unit of Curtiss-Wright Flow Control Company
- TPC Wire & Cable Corp.

Cable Assemblies: Cont Rod Position Indicator

- Mirion Technologies
- Rockbestos-Surprenant Cable Corporation
- Scientech, a business unit of Curtiss-Wright Flow Control Company

Cable Assemblies: Control Rod Drive Mechanism

- Mirion Technologies
- Scientech, a business unit of Curtiss-Wright Flow Control Company

Cable Assemblies: Core Monitoring

- Mirion Technologies
- Rockbestos-Surprenant Cable Corporation
- Scientech, a business unit of Curtiss-Wright Flow Control Company

Cable Assemblies: Electronic

- Diakont
- Mirion Technologies
- Rolls-Royce
- Scientech, a business unit of Curtiss-Wright Flow Control Company

Cable Assemblies: Fiber Optic

- Mirion Technologies
- Rolls-Royce

Cable Assemblies: Radiation Resistant

- Diakont
- Mirion Technologies
- Rockbestos-Surprenant Cable Corporation
- Rolls-Royce
- Thermo Scientific, NFMS Part of Thermo Fisher Scientific

Cable Assemblies: Thermocouple

- Mirion Technologies
- Rockbestos-Surprenant Cable Corporation
- Scientech, a business unit of Curtiss-Wright Flow Control Company

Cable Maintenance

- Analysis and Measurement Services Corp.
- Fauske & Associates., LLC

Cable Markers

- TECH Products, Inc.
- Uticom Systems Inc.

Cable Tray Hangers

- AZZ / NLI
- Black & Veatch
- Energy Steel & Supply CO.
- Rolls-Royce

Cable Tray Supports

- AZZ / NLI
- Black & Veatch
- Energy Steel & Supply CO.
- James C. White Company
- Rolls-Royce

Cable Trays

- AZZ / NLI
- Energy Steel & Supply CO.
- James C. White Company
- Rolls-Royce

Cable: Coaxial

- Diakont
- General Cable
- Mirion Technologies
- Rockbestos-Surprenant Cable Corporation

Cable: Control

- Diakont
- General Cable
- Rockbestos-Surprenant Cable Corporation
- TPC Wire & Cable Corp.

Cable: Electronic

Rockbestos-Surprenant Cable Corporation

Cable: Fiber Optic

General Cable
Uticom Systems Inc.

Cable: Flame Resistant

- Diakont
- General Cable
- Mirion Technologies
- Rockbestos-Surprenant Cable Corporation
- TPC Wire & Cable Corp.

Cable: High-Temperature

- Diakont
- Mirion Technologies
- Rockbestos-Surprenant Cable Corporation
- TPC Wire & Cable Corp.

Cable: Instrumentation

- Diakont
- General Cable
- Mirion Technologies
- Rockbestos-Surprenant Cable Corporation

Cable: Mineral Insulated

- Mirion Technologies

Cable: Radiation Resistant

- C.J. Enterprises
- Diakont
- General Cable
- Mirion Technologies
- Nutherm International, Inc.
- Rockbestos-Surprenant Cable Corporation

Cable: Safety-Related

- AZZ / NLI
- Diakont
- General Cable
- Mirion Technologies
- Nutherm International, Inc.
- Rockbestos-Surprenant Cable Corporation



TURN KEY EMERGENCY POWER SOLUTIONS

TPC has developed a new program called **S.T.E.P.S.—Super-Trex Emergency Power Solutions**—that focuses on turn key solutions for Flex / Fukushima “beyond design” strategies. This eight step process will help identify the cable, connector and container specifications for your facilities temporary power requirements.

TPC’s long-lasting, dependable wire and cable products solve the most difficult application problems in the **harshest environments** resulting in lower overall costs and increased production time. **TPC outperforms and outlasts ordinary cable 10:1.**

Learn more www.tpcwire.com.

TPC Wire & Cable Corp. has a Quality Program committed to 10CFR50 Appendix B/10CFR21. It follows the guidance of ASME NQA-1, 2008/09a.



TPC WIRE & CABLE CORP.
EXPECT HIGH PERFORMANCE®

TPC can design a “plug and play” / quick connect system for either power, control or data cables that can be quickly deployed by maintenance and non-maintenance personnel alike.



POWER & CONTROL CABLE



MOLDED LOCKING POWER ASSEMBLIES



STORAGE CONTAINERS

Thermo Scientific, NFMS Part of Thermo
Fisher Scientific
• TPC Wire & Cable Corp.

Cable: Signal
• Diakont
• Mirion Technologies
Rockbestos-Surprenant Cable Corporation

Cable: Switchboard
General Cable
Rockbestos-Surprenant Cable Corporation

Cable: Thermocouple
General Cable
• Mirion Technologies
Rockbestos-Surprenant Cable Corporation

CAD
Black & Veatch
• HukariAscendent
• Rolls-Royce

CAD: Conversion
Black & Veatch
• HukariAscendent

Calculations: Code Sizing
Black & Veatch
• Joseph Oat Corporation
Precision Custom Components, LLC

Calibration Instruments
F+J Specialty Products, Inc.
• HI-Q Environmental Products Company

Calibration Services
F+J Specialty Products, Inc.
• G.D. Barri & Associates, Inc.
• HI-Q Environmental Products Company
Laboratory Services
Laboratory Testing Inc.
• Mirion Technologies
• NUCON International, Inc.
Wyle Laboratories, Inc.

Calibration Systems
Gammasonics Institute for Medical Research

Calibration: Radiation Monitoring Systems
Gammasonics Institute for Medical Research
• Mirion Technologies

Calibration: Torque Tool
Heat Exchanger Products Corp.

Calibrators: Dosimeter
• Mirion Technologies

Calibrators: Gamma Survey Instrument
Gammasonics Institute for Medical Research
Hopewell Designs, Inc.
• NUCON International, Inc.

Calibrators: Instrument
• HI-Q Environmental Products Company
Hopewell Designs, Inc.
• Mirion Technologies

Calibrators: Radioisotope Dose
Biodex Medical Systems, Inc.

Calorimeters: Isothermal
• Fauske & Associates., LLC

Camera Positioners
• Diakont
Lights, Camera, Action LLC
Remote Ocean Systems (ROS)

Camera Systems: Miniature
• Diakont
• Mirion Technologies
• Rolls-Royce
• Thermo Scientific-CIDTEC, (Part of Thermo Fisher Scientific)

Camera Tubes: Radiation Hardened Television
• Diakont
Lights, Camera, Action LLC
• Mirion Technologies
• Thermo Scientific-CIDTEC, (Part of Thermo Fisher Scientific)

Cameras: Closed-Circuit Television
• Diakont
Lights, Camera, Action LLC
• Mirion Technologies
• Rolls-Royce
• Thermo Scientific-CIDTEC, (Part of Thermo Fisher Scientific)

Cameras: High-Temperature
• Diakont
• Mirion Technologies
• Rolls-Royce

Cameras: Inspection
• Diakont
Lights, Camera, Action LLC
• Mirion Technologies
• Rolls-Royce
• Thermo Scientific-CIDTEC, (Part of Thermo Fisher Scientific)

Cameras: Underwater
• Diakont
Lights, Camera, Action LLC
• Mirion Technologies
Remote Ocean Systems (ROS)
• Rolls-Royce
• Thermo Scientific-CIDTEC, (Part of Thermo Fisher Scientific)

Carbon: Activated
• AAF International
• HI-Q Environmental Products Company
• NUCON International, Inc.

Carrier: Radionuclide
Biodex Medical Systems, Inc.

Casks: Storage
• AT&F Nuclear, Inc, Division of AT & F
• Energy Steel & Supply CO.
Holtec International
• Oregon Iron Works, Inc
Precision Custom Components, LLC
• Rolls-Royce
• Siempelkamp Nukleartechnik GmbH
SKODA JS a.s.

Casks: Transport
• American Crane & Equipment Corp.
• AT&F Nuclear, Inc, Division of AT & F
• Energy Steel & Supply CO.
Holtec International
• Oregon Iron Works, Inc
Precision Custom Components, LLC
• Rolls-Royce
• Siempelkamp Nukleartechnik GmbH

Castings
• AZZ / NLI
• Rolls-Royce
• Siempelkamp Nukleartechnik GmbH

Castings: Carbon Steel
• AZZ / NLI
• Energy Steel & Supply CO.
• Rolls-Royce
• Trust Manufacturing

Castings: Iron
• AZZ / NLI
• Energy Steel & Supply CO.
• Rolls-Royce
• Siempelkamp Nukleartechnik GmbH

Castings: Lead
• Rolls-Royce
Seafab Metal Company

Castings: Metal
• AZZ / NLI
• Energy Steel & Supply CO.
• Rolls-Royce
• Trust Manufacturing

Castings: Stainless Steel
• AZZ / NLI
• Energy Steel & Supply CO.
• Rolls-Royce
• Trust Manufacturing

Cavity Cleaning
Fuel Tank Maintenance Company LLC
Tri Nuclear Corporation

Centers: Electric Load
• AZZ / NLI

Ceramics
• Ceradyne Boron Products

Chamber Detectors: Air Ionization
• Mirion Technologies

Chambers: Fission
• Mirion Technologies

Chambers: Gamma Ion
• Mirion Technologies

Chambers: Ion
• Mirion Technologies

Chambers: Ionization
• Mirion Technologies

Chambers: Moveable In-Core Fission
• Mirion Technologies

Chambers: Reactor Control
• Mirion Technologies

Channels: BWR Fuel
• GE Hitachi Nuclear Energy
Veridiam

Characterization: Facility
BHI Energy
Black & Veatch
• HukariAscendent

Characterization: Site
Black & Veatch
Golder Associates Ltd.
• HukariAscendent
S.M. Stoller Corp.

Charcoals: Radioiodine Laboratory Testing
• NUCON International, Inc.

Check Valve Application Review
Black & Veatch
Valcor Engineering Corporation

Chemicals: Decontamination
• Siempelkamp Nukleartechnik GmbH

Chemistry Data Management Systems
• Sciencetech, a business unit of Curtiss-Wright
Flow Control Company

Chemistry Services
• Fauske & Associates., LLC
• Herguth Laboratories
• Sciencetech, a business unit of Curtiss-Wright
Flow Control Company

Chillers
• AAF International
• AZZ / NLI
• Energy Steel & Supply CO.
Lytron

Chips: Coprocessor
• AZZ / NLI

Chips: Memory
• AZZ / NLI

Chromatography
Biodex Medical Systems, Inc.

Circuit Breaker Maintenance
ATC-Nuclear
• AZZ / NLI
• Sciencetech, a business unit of Curtiss-Wright
Flow Control Company

Circuit Breaker Retrofitting
• AZZ / NLI
Black & Veatch
• Sciencetech, a business unit of Curtiss-Wright
Flow Control Company
Wyle Laboratories, Inc.



Through Excellence.

Mirion Technologies is at the forefront of global trends in radiation monitoring, detection, and services that are shaping our world today.

Our products and services are used in more than 90% of the global fleet of active commercial nuclear power reactors.

We are one of the only companies that offer radiation detection, measurement, analysis and monitoring systems, and services to satisfy customer requirements throughout the NPP life cycle - including mining, enrichment, fuel manufacturing, nuclear power generation, waste management, and fuel reprocessing.

At Mirion, we leverage our industry and technical expertise in detection and monitoring to provide exceptional products that our customers' trust and depend on.

For more information on the full line of Mirion products and services, visit us online:
www.mirion.com



MIRION
TECHNOLOGIES

Our brands:



Your Budget Deserves Better



Disposable protective clothing might offer a little convenience, but its costs add up quickly. Some are quantifiable, such as two-fold higher cost per use, ripouts, and failed RCZ entries. Others are less obvious but are costly just the same - sloppy workforce image, improper fit, wearer discomfort, heat stress, and high environmental impact.



Spend your budget wisely. For half the cost of disposables, ProTech launderable garments never rip out, have no insulative heat stress value (EPR1), no customer radwaste when leased, a 94% smaller carbon footprint, and tailoring that looks, fits, and performs like a real garment . . . because it is.

ISO 9001

ISO 14001



USA • Canada • Germany • UK • The Netherlands

A subsidiary of UniFirst Corporation

(800) 344-3824 • www.UniTechUS.com

Circuit Breakers: Low-Voltage Air, Safety-Related

- AZZ / NLI
- Black & Veatch
- Nutherm International, Inc.

Circuit Breakers: Molded Case, Safety-Related

- AZZ / NLI
- Black & Veatch
- Nutherm International, Inc.

Circuit Breakers: Safety-Related

- AZZ / NLI
- GE Hitachi Nuclear Energy
- Nutherm International, Inc.
- Scientech, a business unit of Curtiss-Wright
- Flow Control Company
- Wyle Laboratories, Inc.

Cladding

- Energy Steel & Supply CO.
- Joseph Oat Corporation
- Precision Custom Components, LLC
- TW Metals - Nuclear Materials Solutions

Cladding: Epoxy

- Plastocor, Inc.

Clamps: Chain

- American Crane & Equipment Corp.

Cleaners

- Conco Systems, Inc.

Cleaners: RV Flange

- Scientech, a business unit of Curtiss-Wright
- Flow Control Company

Cleaners: RV Stud

- Scientech, a business unit of Curtiss-Wright
- Flow Control Company
- Siempelkamp Nukleartechnik GmbH

Cleaners: RV Stud Hole

- Scientech, a business unit of Curtiss-Wright
- Flow Control Company
- Siempelkamp Nukleartechnik GmbH

Cleaning Equipment: Tube

- Conco Systems, Inc.

Cleaning Service

- Conco Systems, Inc.
- Fuel Tank Maintenance Company LLC
- UniTech Services Group, Inc., Div. of Unifirst Corp.

Cleaning System

- Conco Systems, Inc.

Cleaning: Chemical Processes

- UniTech Services Group, Inc., Div. of Unifirst Corp.

Cleaning: CO2 Blast

- Schulz Electric Company
- UniTech Services Group, Inc., Div. of Unifirst Corp.

Cleaning: Heat Exchanger Tube

- Conco Systems, Inc.
- Energy Steel & Supply CO.
- EST Group, a business unit of Curtiss-Wright
- Flow Control Company

Cleaning: Ice Blasting

- EST Group, a business unit of Curtiss-Wright
- Flow Control Company

Cleaning: Steam

- Schulz Electric Company

Cleaning: Steam Generator

- Rolls-Royce

Clothing: Protective

- Euclid Garment Manufacturing Company
- Frham Safety Products, Inc.
- LANCS Industries Holdings, LLC.
- Mohawk Industrial & Nuclear Supply, Inc.
- UniTech Services Group, Inc., Div. of Unifirst Corp.

Clothing: Protective, Fabrics

- Euclid Garment Manufacturing Company
- Frham Safety Products, Inc.
- Kinectrics Incorporated
- LANCS Industries Holdings, LLC.
- UniTech Services Group, Inc., Div. of Unifirst Corp.

Coating Application Services

- Fuel Tank Maintenance Company LLC
- Plastocor, Inc.

Coating: Metal

- Lights, Camera, Action LLC

Coating: Underwater

- Lights, Camera, Action LLC
- Underwater Construction Corporation

Coatings

- BHI Energy
- Performance Contracting Inc. (PCI)
- Underwater Construction Corporation

Coatings Testing

- Kinectrics Incorporated
- Underwater Construction Corporation

Coatings: Corrosion-Resistant

- Plastocor, Inc.

Coils: Cooling

- AAF International
- Aerofin
- AZZ / NLI
- Rolls-Royce

Coils: Heating

- Aerofin
- AZZ / NLI
- Rolls-Royce

Commercial-Grade Dedication

- AT&F Nuclear, Inc, Division of AT & F
- AZZ / NLI
- Energy Steel & Supply CO.
- Fauske & Associates., LLC
- HF Controls
- Joseph Oat Corporation
- Nutherm International, Inc.
- Oregon Iron Works, Inc
- Precision Custom Components, LLC
- Rolls-Royce
- Sargent & Lundy
- Schulz Electric Company
- Trust Manufacturing
- TW Metals - Nuclear Materials Solutions
- Wyle Laboratories, Inc.

Commissioning Services

- Black & Veatch
- Rolls-Royce
- Siempelkamp Nukleartechnik GmbH

Communications Accessories: Prot. Clothing

- Euclid Garment Manufacturing Company
- Frham Safety Products, Inc.

Communications Systems

- BHI Energy
- Black & Veatch
- Tecnomat, S.A.

Compactors

- Container Products Corporation
- S&G Enterprises, Inc.
- Waste Control Systems, Inc.

Component Handling

- American Crane & Equipment Corp.

Compressors

- AZZ / NLI

Computational Fluid Dynamic Analysis

- GE Hitachi Nuclear Energy

Computer System Development

- Black & Veatch
- Tecnomat, S.A.

Computers: Plant Process

- Scientech, a business unit of Curtiss-Wright
- Flow Control Company

FRHAM SAFETY PRODUCTS, INC.

NASHVILLE, TN (615.254.0841) ROCK HILL, SC (803.366.5131)

When Comparing Apples to Apples

OREX vs. LAUNDERABLES



OREX
Clean and Green



LAUNDERABLES
Used and Abused

Nuclear Safety Protection Choice

OREX™



The Question of Protection

OREX is the only garment in the U.S. certified to actually "protect" workers from radioactive contamination. Woven, reusable, laundered garments contain thousands of holes per square inch, allowing particles to penetrate after laundering.



Computers: Replacement

Black & Veatch

Computers: Upgrades

Sargent & Lundy

Concrete Cutting

Cutting Edge Services Corporation

Cutting Technologies

- Siempelkamp Nukleartechnik GmbH

Concrete Repair Materials

- Kinectrics Incorporated

Concrete Services

Nuclear Shielding Supplies & Service

Condenser Analysis/Inspection Services

Conco Systems, Inc.

- Rolls-Royce

Condenser Expansion Joint Replacement

Aquilex WSI Nuclear Services

Enertech, a business unit of Curtiss-Wright

Flow Control Company

Condenser Leak Detection

Conco Systems, Inc.

- EST Group, a business unit of Curtiss-Wright

Flow Control Company

ILD, Inc.

Condenser Rebuilding

- EST Group, a business unit of Curtiss-Wright

Flow Control Company

Condenser Repair

Conco Systems, Inc.

- EST Group, a business unit of Curtiss-Wright

Flow Control Company

Plastocor, Inc.

Condenser Retubing

- EST Group, a business unit of Curtiss-Wright

Flow Control Company

Condenser Tube Cleaning

Conco Systems, Inc.

- EST Group, a business unit of Curtiss-Wright

Flow Control Company

Condenser Tube Plugs

Conco Systems, Inc.

- Energy Steel & Supply CO.

- EST Group, a business unit of Curtiss-Wright

Flow Control Company

Heat Exchanger Products Corp.

- Joseph Oat Corporation

Powerfect

Condensers

- AZZ / NLI

Black & Veatch

- Joseph Oat Corporation

Condensing Units: Air Cooled

- AAF International

- AZZ / NLI

- Ellis & Watts Global Industries, LLC.

Condensing Units: Water Cooled

- AAF International

- AZZ / NLI

- Ellis & Watts Global Industries, LLC.

Configuration Management

Hurst Technologies Corp..

Sargent & Lundy

Connections: Electrical

- AZZ / NLI

Connectors

BURNDY

ITT Veam ILC

- Scientech, a business unit of Curtiss-Wright

Flow Control Company

Connectors: Circuit Board

- AZZ / NLI

Connectors: Electrical

- AZZ / NLI

- BIRNS, Inc.

BURNDY

ITT Veam ILC

- Mirion Technologies

- Scientech, a business unit of Curtiss-Wright

Flow Control Company

Connectors: Electrical, Hot Cell

STAUBLI Corporation

Connectors: Fluid, Hot Cell

STAUBLI Corporation

Connectors: Metal-to-Metal Clamp

- Energy Steel & Supply CO.

- Mirion Technologies

Connectors: Quick Disconnect

- AZZ / NLI

- Energy Steel & Supply CO.

STAUBLI Corporation

Connectors: Quick Disconnect, Safety-Related

- Energy Steel & Supply CO.

ITT Veam ILC

- Mirion Technologies

Namco Controls

Nutherm International, Inc.

STAUBLI Corporation

Valcor Engineering Corporation

Construction

- Bechtel Power

- Day & Zimmermann ECM

- Energy Steel & Supply CO.

- Zachry Nuclear Engineering, Inc

Construction Products

- Energy Steel & Supply CO.

- EST Group, a business unit of Curtiss-Wright

Flow Control Company

Lonza Wood Protection

Construction Services

- Bechtel Power

- Bigge Power Constructors

- EST Group, a business unit of Curtiss-Wright

Flow Control Company

Fuel Tank Maintenance Company LLC

- The Shaw Group

URS Corporation

Consulting

BHI Energy

Black & Veatch

- EST Group, a business unit of Curtiss-Wright

Flow Control Company

- G.D. Barri & Associates, Inc.

- NUCON International, Inc.

RCM Technologies, Inc.

Sargent & Lundy

Stevenson Stewart International Inc.

- The Shaw Group

URS Corporation

Consulting: Acoustic Emission

- Fauske & Associates., LLC

Golder Associates Ltd.

Consulting: Ancillary Systems Design

Sargent & Lundy

- Zachry Nuclear Engineering, Inc

Consulting: Appendix R

EPM, Inc

- Fauske & Associates., LLC

Sargent & Lundy

- Zachry Nuclear Engineering, Inc

Consulting: Balance-of-Plant

- Bechtel Power

- Fauske & Associates., LLC

ILD, Inc.

Sargent & Lundy

- Zachry Nuclear Engineering, Inc

Consulting: Biological Sciences

Golder Associates Ltd.

S.M. Stoller Corp.

Consulting: Business Management

Sargent & Lundy

Consulting: Chemical Cleaning

- Kinectrics Incorporated

Consulting: Chemical Decontamination

- Candu Energy Inc

- Fauske & Associates., LLC

- Siempelkamp Nukleartechnik GmbH

Consulting: Chemistry

- Fauske & Associates., LLC

Consulting: Clean Air

- NUCON International, Inc.

Consulting: Component Design

- Fauske & Associates., LLC

- Siempelkamp Nukleartechnik GmbH

Consulting: Computer Network Security

Hurst Technologies Corp..

Consulting: Computer Software

Research Software Consulting Group, Inc.

Standish Technologies, International

The Delphi Groupe, Inc.

Utility Resource Associates

- Zachry Nuclear Engineering, Inc

Consulting: Computer Systems

Sargent & Lundy

Consulting: Computer-Aided Engineering

- Siempelkamp Nukleartechnik GmbH

Consulting: Configuration Management

Sargent & Lundy

Consulting: Control Systems

- Diakont

Hurst Technologies Corp..

- Zachry Nuclear Engineering, Inc

Consulting: Cooling Systems

- Zachry Nuclear Engineering, Inc

Consulting: Data Acquisition Systems

Sargent & Lundy

- Zachry Nuclear Engineering, Inc

Consulting: Decommissioning

Advanced Consulting Group, Inc.

BHI Energy

Cutting Edge Services Corporation

Cutting Technologies

- Fauske & Associates., LLC

Golder Associates Ltd.

Rogante Engineering Office

S.M. Stoller Corp.

Sargent & Lundy

- Siempelkamp Nukleartechnik GmbH

WorleyParsons Polestar

- Zachry Nuclear Engineering, Inc

Consulting: Decontamination

BHI Energy

- Candu Energy Inc

- Fauske & Associates., LLC

Sargent & Lundy

- Siempelkamp Nukleartechnik GmbH

Consulting: Design & Documentation

- Rolls-Royce

Sargent & Lundy

- Siempelkamp Nukleartechnik GmbH

- Structural Integrity Associates, Inc.

Consulting: Design Assessment

- Rolls-Royce

- Siempelkamp Nukleartechnik GmbH

- Zachry Nuclear Engineering, Inc

Consulting: Design Basis Documentation

- Bechtel Power

CTR Technical Services, Inc.

- Rolls-Royce

Sargent & Lundy

- Siempelkamp Nukleartechnik GmbH

- Zachry Nuclear Engineering, Inc

Consulting: Design Reports

CTR Technical Services, Inc.

- Rolls-Royce

- Zachry Nuclear Engineering, Inc

Consulting: Digital Systems

- Diakont
Sargent & Lundy

Consulting: Economic Analysis

- Sargent & Lundy

Consulting: Electrical

- Cutsforth
- Kinectrics Incorporated
Sargent & Lundy
- Zachry Nuclear Engineering, Inc

Consulting: Emergency Preparedness

- Fauske & Associates., LLC

Consulting: Engineering

- American Crane & Equipment Corp.
- Bechtel Power
Black & Veatch
- Candu Energy Inc
CORE, Inc.
CTR Technical Services, Inc.
Design Engineering Analysis Corporation
- Fauske & Associates., LLC
Golder Associates Ltd.
- Joseph Oat Corporation
NPTS, Inc.
Power & Energy Systems Services
- Rolls-Royce
Sargent & Lundy
- Scientech, a business unit of Curtiss-Wright
Flow Control Company
- Siempelkamp Nukleartechnik GmbH
- Structural Integrity Associates, Inc.
- Tecnatom, S.A.
The Delphi Groupe, Inc.
Volian Enterprises, Inc.
- Zachry Nuclear Engineering, Inc

Consulting: Engineering Mechanics

- American Crane & Equipment Corp.
- Fauske & Associates., LLC
- Rolls-Royce

- Siempelkamp Nukleartechnik GmbH
- Tecnatom, S.A.
- Zachry Nuclear Engineering, Inc

Consulting: Engineering: BWR

- Bechtel Power
- Fauske & Associates., LLC
- Siempelkamp Nukleartechnik GmbH
- Structural Integrity Associates, Inc.

Consulting: Environmental

- GEL Engineering LLC
- Golder Associates Ltd.
- Kinectrics Incorporated
Murray and Trettel, Inc.
S.M. Stoller Corp.
Sargent & Lundy
- The Shaw Group
WorleyParsons Polestar

Consulting: Environmental Analysis

- S.M. Stoller Corp.
- Tecnatom, S.A.

Consulting: Environmental Management

- Eberline Services Inc.
- Gammasonics Institute for Medical Research
S.M. Stoller Corp.

Consulting: Erosion/Corrosion Program

- Jonas, Inc.
- Zachry Nuclear Engineering, Inc

Consulting: Expert Systems

- HukariAscendent

Consulting: Filtration

- NUCON International, Inc.

Consulting: Fire Protection

- EPM, Inc
- Fauske & Associates., LLC
- HukariAscendent
Sargent & Lundy
- Zachry Nuclear Engineering, Inc

Consulting: Fluid Dynamic Analysis

- Fauske & Associates., LLC
Sargent & Lundy
- Siempelkamp Nukleartechnik GmbH
- Zachry Nuclear Engineering, Inc

Consulting: Fluid Flow

- Fauske & Associates., LLC
- Siempelkamp Nukleartechnik GmbH
- Zachry Nuclear Engineering, Inc

Consulting: Fracture Mechanics

- Fauske & Associates., LLC
- Structural Integrity Associates, Inc.

Consulting: FSAR Licensing Review

- Fauske & Associates., LLC
- HukariAscendent
Sargent & Lundy
- Scientech, a business unit of Curtiss-Wright
Flow Control Company
- Zachry Nuclear Engineering, Inc

Consulting: Geohydrological Studies

- Golder Associates Ltd.,
S.M. Stoller Corp.

Consulting: Hazardous Materials Management

- Golder Associates Ltd.
- HukariAscendent
- Rolls-Royce

Consulting: Hazardous Waste Management

- Candu Energy Inc
- HukariAscendent
- Kinectrics Incorporated
- Rolls-Royce
Sargent & Lundy

Consulting: Health Physics

- BHI Energy
- DADE Moeller & Associated, Inc.
- Eberline Services Inc.
- Golder Associates Ltd.

Directory 2014

2014 Directory

All nuclear power industry suppliers all over the world who are not listed in the 2013 Directory may register for the 2014 Directory by emailing a request that includes complete contact information to:

Nuclear Plant Journal, Directory 2014 Listing Department, 1400 Opus Place, Suite 904, Downers Grove, IL 60515 USA; E-mail: NPJ@goinfo.com

Suppliers listed in the 2013 Directory will receive the 2014 Directory mailing with a list of their products and services as they appeared in the 2013 Directory.

A mailing will also be sent during the fall of 2013 to all interested suppliers who wish to list their products and services in the Product & Service Directory 2014.

Directory Policy

EQES, Inc. reserves the right of inclusion of any supplier. Listings are compiled from information submitted by suppliers. All efforts are made by *Nuclear Plant Journal* to ensure

the accurate representation of the listed products and services. EQES, Inc., the publisher of *Nuclear Plant Journal*, is not responsible for any errors or omissions in the Directory listings.

The listings and advertisements provided in this Directory should not be construed as an endorsement by *Nuclear Plant Journal* or EQES, Inc. Every purchaser should thoroughly evaluate each listed resource before making a purchasing decision.

Information included in the Directory is for the exclusive use of the purchasers in the nuclear power industry. Any other use of the Directory will constitute a violation of the copyright laws of the United States. No part of this Directory may be reproduced in any form for any purpose other than the purchase of the listed products and services.

© Copyright 2012 EQES, Inc. All rights reserved.

Phone: (630) 858-6161, ext. 103

Fax: (630) 852-8787

Web Site: www.NuclearPlantJournal.com

Email: michelle@goinfo.com

Consulting: Heat Exchangers

- Conco Systems, Inc.
- Fauske & Associates., LLC
- Joseph Oat Corporation
- Powerfect
- Rolls-Royce
- Structural Integrity Associates, Inc.
- Zachry Nuclear Engineering, Inc

Consulting: Heat Transfer

- Conco Systems, Inc.
- EST Group, a business unit of Curtiss-Wright
- Flow Control Company
- Fauske & Associates., LLC
- Joseph Oat Corporation
- Zachry Nuclear Engineering, Inc

Consulting: HEPA Systems

- Jacox Associates
- NUCON International, Inc.

Consulting: Human Effectiveness

- Conger & Elsea, Inc.

Consulting: Human Factors Engineering

- Diakont
- Rolls-Royce
- The Macris Group

Consulting: HVAC Systems

- AZZ / NLI
- NUCON International, Inc.
- Sargent & Lundy
- Zachry Nuclear Engineering, Inc

Consulting: Hydraulic

- Fauske & Associates., LLC
- Zachry Nuclear Engineering, Inc

Consulting: Information Management

- Rolls-Royce
- Sargent & Lundy

Consulting: In-Service Inspection Programs

- Rolls-Royce

- Sargent & Lundy
- Structural Integrity Associates, Inc.
- Tecnatom, S.A.

Consulting: Instrumentation & Calibration

- Sargent & Lundy
- Tecnatom, S.A.
- Zachry Nuclear Engineering, Inc

Consulting: License Renewal

- Bechtel Power
- Fauske & Associates., LLC
- HukariAscendent
- Sargent & Lundy
- Scientech, a business unit of Curtiss-Wright
- Flow Control Company
- Structural Integrity Associates, Inc.
- URS Corporation
- Zachry Nuclear Engineering, Inc

Consulting: Licensee Event Reports

- Conger & Elsea, Inc.

Consulting: Licensing

- Golder Associates Ltd.
- HukariAscendent
- Lightbridge Corporation
- Sargent & Lundy
- Scientech, a business unit of Curtiss-Wright
- Flow Control Company
- Siempelkamp Nukleartechnik GmbH
- VGSSolutions

Consulting: Life Cycle Management

- Fauske & Associates., LLC
- Sargent & Lundy
- Structural Integrity Associates, Inc.
- Zachry Nuclear Engineering, Inc

Consulting: Literature Searches

- Interdevelopment, Inc.

Consulting: Litigation Support

- Howard L. Sobel, P.E.
- Interdevelopment, Inc.
- Structural Integrity Associates, Inc.

Consulting: LOCA Analysis

- Fauske & Associates., LLC
- Sargent & Lundy

Consulting: Maintenance

- CORE, Inc.
- Cutsforth
- EST Group, a business unit of Curtiss-Wright
- Flow Control Company
- Herguth Laboratories
- Sargent & Lundy

Consulting: Maintenance Programs

- CORE, Inc.
- Herguth Laboratories
- HukariAscendent
- Sargent & Lundy

Consulting: Management

- Collier Associates, Inc.
- HukariAscendent
- Sargent & Lundy

Consulting: Management Effectiveness Reviews

- Collier Associates, Inc.
- Conger & Elsea, Inc.
- HukariAscendent

Consulting: Margin Management Programs

- Fauske & Associates., LLC
- Zachry Nuclear Engineering, Inc

Consulting: Marketing

- Interdevelopment, Inc.

Consulting: Material Management

- Sargent & Lundy

Consulting: Materials Analysis

- Candu Energy Inc
- Rogante Engineering Office

Consulting: Materials Engineering

- Candu Energy Inc
- Sargent & Lundy
- Tecnatom, S.A.

Consulting: Metallurgical Analysis

- Structural Integrity Associates, Inc.

Consulting: Meteorological

- Golder Associates Ltd.
- Murray and Trettel, Inc.

Consulting: Modifications

- ILD, Inc.
- Sargent & Lundy
- Siempelkamp Nukleartechnik GmbH
- Zachry Nuclear Engineering, Inc

Consulting: Motors

- Schulz Electric Company

Consulting: Nuclear

- Bechtel Power
- Black & Veatch
- Candu Energy Inc
- CTR Technical Services, Inc.
- DCS Systems Inc.
- Fauske & Associates., LLC
- Golder Associates Ltd.,
- Rolls-Royce
- Sargent & Lundy
- Scientech, a business unit of Curtiss-Wright
- Flow Control Company
- Structural Integrity Associates, Inc.
- Studsvik, Inc
- TransWare Enterprises Inc.
- Utility Resource Associates
- WorleyParsons Polestar

Consulting: Nuclear Fuel Cycles

- Candu Energy Inc
- DCS Systems Inc.

Consulting: Nuclear Steam Supply System

- Fauske & Associates., LLC
- Scientech, a business unit of Curtiss-Wright
- Flow Control Company



Engineering and Testing Services

Equipment Qualification

- LOCA and HELB facilities for current and next generation
- Thermal and radiation aging
- Activation energy and material evaluation
- Seismic qualification
- EMC/EMI testing and evaluation
- Radiation shielding or thermal lag analysis
- Commercial grade dedication





Russell Lee
 (630) 887-5285, rlee@fauske.com
FAUSKE.COM



NUCON[®] Products and Services

10CFR50 Appendix B and NQA-1 QA Program
Licensed Radioisotope Laboratory - ASME Section VIII

AIR & GAS TREATMENT SYSTEMS AND COMPONENTS

- Complete ESF and non-ESF Air Treatment Systems
- Portable Air Cleaning Units (P-NATS)
- Type II, III and IV Adsorber Cells
- Adsorber Refilling Services
- Gaseous Radwaste and Off-Gas Systems
- Target Dissolver Off-Gas Systems
- Mercury Control Equipment and Systems for Mixed Waste Disposal Operations
- Acid Gas Removal Equipment and Systems
- Gas & Liquid Phase Treatment Systems

TESTING INSTRUMENTS

- Tracer Gas Detectors and Generators (R-11, R-12, R-112 & R-112A, HCFC-123, R-134a, 1-bromobutane)
- Aerosol Detectors and Generators (DOP, PAO, DOS, etc.)
- Pressure Detectors (Portable)
- Calibration Services; (Halide & Aerosol Instruments, Airflow, Pressure and Temperature Measurement Instruments)

ADSORBENTS

- Radioiodine Removal Carbons (NUSORB[®] KITEG II[™], TEG[™] & KIG[™])
- Noble Gas Delay Bed Carbons
- Mercury Removal Adsorbents (MERSORB[®] series)
- Acid Gas Removal (NUSORB[®] KINA[™] series) and Systems
- VOC Removal (NUSORB[®] GC[™] series)

RADIOISOTOPE LABORATORY SERVICES

- Radioiodine Removal Performance Testing of New and Used Carbons per USNRC Regulatory Guides, 1.52 (all revisions) & 1.140 (all revisions) and ASTM D3803, RDT-M16-1T, and DIN & DNR
- ¹³³Xe / ⁸⁵Kr Dynamic "K" Testing
- Various Testing Using Radioisotope Tracers

ON-SITE TESTING AND CONSULTING

- In-place Leak Testing (ASME: N510 & N511 and AG-1)
- Control Room Envelope In Leakage Testing (ASTM E741-2000)
- Acceptance Testing (ASME N510 and AG-1)
- Air Balancing
- Duct and Housing Leakage Testing
- Compliance Review of ESF Air Cleaning Systems
- Personnel Training (ANSI/ASME and ASME AG-1)

LABORATORY AND ENGINEERING SERVICES

- Control Room Habitability Improvements and Upgrades
- Radioisotope "Heat Decay" Studies
- Chemical Effects Studies (on adsorbants)
- Treatment Technology Development and Design



NUCON[®] International, Inc

7000 Huntley Road
Columbus, OH 43229

Phone: 614-846-5710 - Fax: 614-431-0858

Web Site: www.nucon-int.com

Consulting: Operations

- HukariAscendent
Sargent & Lundy
- Tecnatom, S.A.

Consulting: Operations Analysis

- HukariAscendent
- Tecnatom, S.A.

Consulting: Operator Performance Enhancement

- HukariAscendent

Consulting: Organization Effectiveness

- Collier Associates, Inc.
- Conger & Elsea, Inc.
- HukariAscendent
Human and Organizational Performance Improvement
- The Macris Group

Consulting: Organizational Development

- HukariAscendent
- The Macris Group

Consulting: Outage Management

- Sargent & Lundy
- Structural Integrity Associates, Inc.

Consulting: Pipe Support

- Bechtel Power
- Fauske & Associates., LLC
- Rolls-Royce
- Zachry Nuclear Engineering, Inc

Consulting: Piping

- Rolls-Royce
- Sargent & Lundy
- Structural Integrity Associates, Inc.
- Zachry Nuclear Engineering, Inc

Consulting: Planning & Scheduling

- Rolls-Royce

Consulting: Plant Life Extension

- Candu Energy Inc
- EST Group, a business unit of Curtiss-Wright
Flow Control Company
- Fauske & Associates., LLC
- HukariAscendent
Sargent & Lundy
- Structural Integrity Associates, Inc.
- Tecnatom, S.A.
- Zachry Nuclear Engineering, Inc

Consulting: Plant Performance Analysis

- Fauske & Associates., LLC
Power & Energy Systems Services
S.M. Stoller Corp.
- Sciencetech, a business unit of Curtiss-Wright
Flow Control Company
- Zachry Nuclear Engineering, Inc

Consulting: Plant Performance Improvement

- CORE, Inc.
- Fauske & Associates., LLC
- GE Hitachi Nuclear Energy
Sargent & Lundy
- Sciencetech, a business unit of Curtiss-Wright
Flow Control Company
- Zachry Nuclear Engineering, Inc

Consulting: Power Needs

- Golder Associates Ltd.

Consulting: Preventive Maintenance

- CORE, Inc.
- Sargent & Lundy
- Structural Integrity Associates, Inc.

Consulting: Problem Solving

- Conger & Elsea, Inc.
- Fauske & Associates., LLC
- Rolls-Royce
- Structural Integrity Associates, Inc.

Consulting: Procedure Development

- HukariAscendent
- Rolls-Royce
- Volian Enterprises, Inc.

Consulting: Procedure Validation

- HukariAscendent
- Rolls-Royce

Consulting: Procedure Verification

- HukariAscendent
- Rolls-Royce

Consulting: Process Safety

- Fauske & Associates., LLC
- HukariAscendent

Consulting: Procurement Support

- HukariAscendent
Interdevelopment, Inc.

Consulting: Productivity Improvement

- CORE, Inc.

Consulting: Program Assessment

- Collier Associates, Inc.
- HukariAscendent
Sargent & Lundy

Consulting: Project Management

- HukariAscendent
- Rolls-Royce
- Zachry Nuclear Engineering, Inc

Consulting: Project Planning

- HukariAscendent
- Rolls-Royce

Consulting: Prudence Studies

- Howard L. Sobel, P.E.
Sargent & Lundy

Consulting: Quality Assurance

- DCS Systems Inc.
- Energy Resources Group, Inc.
- HSB Global Standards
- HukariAscendent
- Rolls-Royce
- Sargent & Lundy
- Theseus Professional Services, LLC
- Trust Manufacturing
- Zachry Nuclear Engineering, Inc

Consulting: Quality Control

- HukariAscendent
- Rolls-Royce
- Sargent & Lundy
- Tecnatom, S.A.

Consulting: Radiation Analysis

- Bevelacqua Resources
- Sargent & Lundy

Consulting: Radiation Monitoring

- Gammasonics Institute for Medical Research

Consulting: Radiochemistry

- Eberline Services Inc.
- Kinectrics Incorporated

Consulting: Radiological

- Applied Analysis Corp.
- Bevelacqua Resources
- Golder Associates Ltd.
- URS Corporation
- WMG, Inc.

Consulting: Radwaste

- Candu Energy Inc
- Eberline Services Inc.
- Golder Associates Ltd.
- Kinectrics Incorporated
- Rolls-Royce
- Sargent & Lundy
- Studsvik, Inc
- The Delphi Groupe, Inc.
- URS Corporation
- WMG, Inc.

Consulting: Reactor Control

- Rolls-Royce

Consulting: Reactor Engineering

- Candu Energy Inc
- CTR Technical Services, Inc.
- Fauske & Associates., LLC

- Rolls-Royce
- TransWare Enterprises Inc.

Consulting: Reactor Materials

- Candu Energy Inc
- Rolls-Royce

Consulting: Reactor Safety

- Candu Energy Inc
- Fauske & Associates., LLC
- Rolls-Royce

Consulting: Reactor Vessel

- Rolls-Royce

Consulting: Records Management Systems

- Rolls-Royce
- Sargent & Lundy

Consulting: Regulatory Compliance

- EPM, Inc
- HukariAscendent
- Lightbridge Corporation
- Rolls-Royce
- Sargent & Lundy
- Sciencetech, a business unit of Curtiss-Wright
Flow Control Company
- WMG, Inc.
- Zachry Nuclear Engineering, Inc

Consulting: Reliability Analysis

- CORE, Inc.
- Fauske & Associates., LLC
- HukariAscendent
Sargent & Lundy
- Sciencetech, a business unit of Curtiss-Wright
Flow Control Company

Consulting: Remote Systems Applications

- Advanced Consulting Group, Inc.
- Candu Energy Inc
- Diakont
- Rolls-Royce
- Tecnatom, S.A.

Consulting: Remotely Operated Vehicles

- Diakont

Consulting: Research & Development

- Fauske & Associates., LLC

Consulting: Residual Life Assessment

- Sargent & Lundy

Consulting: Risk Analysis

- Conger & Elsea, Inc.
- Diakont
- Fauske & Associates., LLC
- Golder Associates Ltd.
- HukariAscendent
- Rolls-Royce
- Sargent & Lundy
- Sciencetech, a business unit of Curtiss-Wright
Flow Control Company

Consulting: Risk Management

- CORE, Inc.
- Fauske & Associates., LLC
- HukariAscendent
- Rolls-Royce
- Structural Integrity Associates, Inc.

Consulting: Robotics

- Candu Energy Inc
- Diakont
- Rolls-Royce

Consulting: Root Cause Analysis

- BHI Energy
- Conger & Elsea, Inc.
- DCS Systems Inc.
- Fauske & Associates., LLC
- HukariAscendent
- Kinectrics Incorporated
- Rolls-Royce
- Sargent & Lundy
- Structural Integrity Associates, Inc.
- Zachry Nuclear Engineering, Inc



HITACHI

Now you can monitor spent fuel pools from a span greater than the Tower Bridge.

GE Hitachi's Spent Fuel Pool Level Monitor (SFPLM) employs proven NUMAC remote electronics to provide continuous, accurate readings of fuel pool levels from distances up to 1,000 feet. An easy-to-read screen and audible "level drop" alerts allow operators to ensure safe, reliable monitoring from the control room. With GE Hitachi's SFPLM and other innovations, we're bridging the gap to support safe and efficient nuclear plant operation.

ge.com/nuclear



Consulting: Scaffolding Design/Engineering

BHI Energy

Consulting: Scientific

- Fauske & Associates., LLC

Consulting: Security

Argonne National Laboratory, Vulnerability Assessment Team
Carpency And Associates., LLC
Sargent & Lundy

Consulting: Seismic

- American Crane & Equipment Corp. Enertech, a business unit of Curtiss-Wright Flow Control Company
- Fauske & Associates., LLC
- Golder Associates Ltd.
- Joseph Oat Corporation
- Sargent & Lundy
- Structural Integrity Associates, Inc.

Consulting: Self-Assessment

BHI Energy
Collier Associates, Inc.
Sargent & Lundy

Consulting: Setpoint Analyses

- Sargent & Lundy
- Zachry Nuclear Engineering, Inc

Consulting: Siting

S.M. Stoller Corp.
Sargent & Lundy

Consulting: Solid Waste Management

- Rolls-Royce

Consulting: Steam Generators

- Candu Energy Inc
- Joseph Oat Corporation
- Rolls-Royce

Consulting: Strategic Planning

Lightbridge Corporation
Sargent & Lundy

Consulting: Stress, Material

- Candu Energy Inc
- Fauske & Associates., LLC

Consulting: Structural

- American Crane & Equipment Corp.
- Fauske & Associates., LLC
- Sargent & Lundy
- Structural Integrity Associates, Inc.
- Zachry Nuclear Engineering, Inc

Consulting: System Design

- HukariAscendent
- Sargent & Lundy
- Zachry Nuclear Engineering, Inc

Consulting: System Safety

- Conger & Elsea, Inc.
- HukariAscendent
- Scientech, a business unit of Curtiss-Wright Flow Control Company
- Zachry Nuclear Engineering, Inc

Consulting: Technical Assessments

- Candu Energy Inc
- DCS Systems Inc.
- HukariAscendent
- Rolls-Royce
- Sargent & Lundy
- Utility Resource Associates
- Zachry Nuclear Engineering, Inc

Consulting: Technical Specifications

- HukariAscendent
- Jacox Associates
- Rolls-Royce

Consulting: Technical Staff

- BHI Energy
- DCS Systems Inc.
- G.D. Barri & Associates, Inc.
- HukariAscendent

Consulting: Television Systems

- Diakont
- Mirion Technologies
- Rolls-Royce

Consulting: Thermal Analysis

- Fauske & Associates., LLC
- Sargent & Lundy
- Siempelkamp Nukleartechnik GmbH
- Zachry Nuclear Engineering, Inc

Consulting: Thermal-Hydraulics

- Applied Analysis Corp.
- Candu Energy Inc
- Fauske & Associates., LLC
- Red Wolf Associates
- Sargent & Lundy
- Zachry Nuclear Engineering, Inc

Consulting: Third Party Review

- Fauske & Associates., LLC
- Lightbridge Corporation
- Rolls-Royce
- Sargent & Lundy
- Zachry Nuclear Engineering, Inc

Consulting: Training

- DCS Systems Inc.
- Rolls-Royce
- Structural Integrity Associates, Inc.
- Tecnatom, S.A.

Consulting: Trend Analysis Program

- CORE, Inc.
- Interdevelopment, Inc.
- Zachry Nuclear Engineering, Inc

Consulting: TRU Waste

- Eberline Services Inc.
- HukariAscendent
- Rolls-Royce
- S.M. Stoller Corp.

Consulting: Tube Plugging

- EST Group, a business unit of Curtiss-Wright Flow Control Company
- Joseph Oat Corporation

Consulting: Valve Actuators

- Copes-Vulcan,SPX Brand
- Enertech, a business unit of Curtiss-Wright Flow Control Company
- Sargent & Lundy

Consulting: Valves

- Copes-Vulcan,SPX Brand
- Enertech, a business unit of Curtiss-Wright Flow Control Company
- Sargent & Lundy

Consulting: Ventilation System

- Zachry Nuclear Engineering, Inc

Consulting: Verification & Validation

- Fauske & Associates., LLC

Consulting: Waste Management

- Candu Energy Inc
- Eberline Services Inc.
- Golder Associates Ltd.
- S.M. Stoller Corp.
- Sargent & Lundy
- Siempelkamp Nukleartechnik GmbH
- WMG, Inc.

Consulting: Water Treatment

Jonas, Inc.
Sargent & Lundy

Contactors: Safety-Related

- AZZ / NLI
- Fauske & Associates., LLC
- Nutherm International, Inc.
- Wyle Laboratories, Inc.

Container: Handling Facility

IHI Transport Machinery Co., Ltd

Containers: Disposal

- Container Products Corporation
- Energy Steel & Supply CO.
- Joseph Oat Corporation
- Siempelkamp Nukleartechnik GmbH

Containers: Fuel

- Precision Custom Components, LLC
- Siempelkamp Nukleartechnik GmbH

Containers: Large-Component SCO Wraps

WMG, Inc.

Containers: Lead

- Biodex Medical Systems, Inc.
- Dufrane Nuclear Shielding, Inc.
- LANCS Industries Holdings, LLC.
- Precision Custom Components, LLC
- Rolls-Royce
- Tri Nuclear Corporation

Containers: Polyethylene

Reef Industries, Inc.

Containers: Radwaste

- AT&F Nuclear, Inc, Division of AT & F
- Biodex Medical Systems, Inc.
- Container Products Corporation
- Dufrane Nuclear Shielding, Inc.
- Joseph Oat Corporation
- Kinectrics Incorporated
- LANCS Industries Holdings, LLC.
- Oregon Iron Works, Inc
- Precision Custom Components, LLC
- Rolls-Royce
- Siempelkamp Nukleartechnik GmbH
- Waste Control Systems, Inc.
- WMG, Inc.

Containers: Shielded

- Biodex Medical Systems, Inc.
- Container Products Corporation
- Dufrane Nuclear Shielding, Inc.
- Frontier Technology Corporation
- LANCS Industries Holdings, LLC.
- Oregon Iron Works, Inc
- Precision Custom Components, LLC
- Rolls-Royce
- Siempelkamp Nukleartechnik GmbH

Containers: Steel

- Container Products Corporation
- Diversified Technologies Services, Inc.
- Dufrane Nuclear Shielding, Inc.
- Energy Steel & Supply CO.
- Oregon Iron Works, Inc
- Precision Custom Components, LLC
- Rolls-Royce
- Trust Manufacturing
- WMG, Inc.

Containers: Storage

- AT&F Nuclear, Inc, Division of AT & F
- Container Products Corporation
- Dufrane Nuclear Shielding, Inc.
- Energy Steel & Supply CO.
- Joseph Oat Corporation
- Precision Custom Components, LLC
- Reef Industries, Inc.
- Rolls-Royce
- Siempelkamp Nukleartechnik GmbH
- UniTech Services Group, Inc., Div. of Unifirst Corp.

Containers: Storage Products

- Biodex Medical Systems, Inc.
- Energy Steel & Supply CO.
- R&G Laboratories, Inc
- Reef Industries, Inc.
- Rolls-Royce
- Siempelkamp Nukleartechnik GmbH

Containers: Transport

- American Crane & Equipment Corp.
- AT&F Nuclear, Inc, Division of AT & F
- Container Products Corporation
- Energy Steel & Supply CO.
- Joseph Oat Corporation
- Oregon Iron Works, Inc
- Precision Custom Components, LLC
- Reef Industries, Inc.
- Rolls-Royce
- Siempelkamp Nukleartechnik GmbH



WHEN EVERY DETAIL MATTERS.

Nuclear experience makes an infinite difference. With that experience comes attention to detail. With attention to detail comes predictability, capability and excellence. At Oregon Iron Works, Inc., (O.I.W.) we build first-class hardware, on time, as promised, with more than 2,000,000 manhours of production logged under nuclear Quality programs. Vast capabilities, combined with our strict Quality Assurance program, means we consistently deliver the oversight and detailed documentation the world's most critical customers demand. When it must be right, it must be O.I.W.

- 320,000 SF Fabrication, Machining & Integration
- 150 Certified ASME Welders, 10 ga. to 12 inch
- Stainless, Inconel, Carbon, Nickel, Titanium, Hastelloy
- 160 Ton Shop Lift Capacity
- CNC Machining, 10 lbs to 100+ tons
- Mechanical Assembly, Integration, Controls
- EPRI Compliant Commercial Grade Dedication



OREGON IRON WORKS, INC.
NUCLEAR PRODUCTS DIVISION



N, NA, NPT, U, U2

Clackamas, OR USA
Vancouver, WA USA
503.653.6300
www.oregoniron.com
sales@oregoniron.com

ASME NQA-1 • 10 CFR PART 50, APP B

- UniTech Services Group, Inc., Div. of Unifirst Corp.
Waste Control Systems, Inc.
- Containers: Waste**
 - Biodex Medical Systems, Inc.
 - Container Products Corporation
 - Dufrane Nuclear Shielding, Inc.
 - Energy Steel & Supply CO.
 - Oregon Iron Works, Inc
 - Precision Custom Components, LLC
 - Rolls-Royce
 - Siempelkamp Nukleartechnik GmbH
 - Trust Manufacturing
- Containment Analysis**
 - Bechtel Power
 - Candu Energy Inc
 - Fauske & Associates., LLC
 - Rolls-Royce
- Containment Products: DOT**
 - Reef Industries, Inc.
- Containment Structures**
 - AT&F Nuclear, Inc, Division of AT & F
 - Energy Steel & Supply CO.
 - LANCS Industries Holdings, LLC.
 - Oregon Iron Works, Inc
 - Precision Custom Components, LLC
- Containment Tents**
 - Frham Safety Products, Inc.
 - Herculite Products
 - LANCS Industries Holdings, LLC.
 - Reef Industries, Inc.
- Contract Engineering Services**
 - American Crane & Equipment Corp.
 - G.D. Barri & Associates, Inc.
 - Joseph Oat Corporation
 - Tecnomat, S.A.
- Control Cabinets**
 - AZZ / NLI
 - AZZ / NLI
 - Energy Steel & Supply CO.
 - Rolls-Royce
 - Schulz Electric Company
- Control Equipment: Power Distribution**
 - AZZ / NLI
- Control Panel Design**
 - AZZ / NLI
 - Schulz Electric Company
 - Scientech, a business unit of Curtiss-Wright Flow Control Company
 - Zachry Nuclear Engineering, Inc
- Control Panels: 1E**
 - AZZ / NLI
 - DRS Consolidated Controls, Inc
 - Nutherm International, Inc.
 - Scientech, a business unit of Curtiss-Wright Flow Control Company
 - Wyle Laboratories, Inc.
- Control Panels: Safety-Related**
 - AZZ / NLI
 - Nutherm International, Inc.
 - Scientech, a business unit of Curtiss-Wright Flow Control Company
 - Wyle Laboratories, Inc.
- Control Rod Control System Maintenance**
 - Scientech, a business unit of Curtiss-Wright Flow Control Company
- Control Rod Drive Maintenance**
 - Scientech, a business unit of Curtiss-Wright Flow Control Company
- Control Rod Drive Mechanisms**
 - SKODA JS a.s.
- Control Room Consoles: Class 1E**
 - AZZ / NLI
 - DRS Consolidated Controls, Inc
 - Scientech, a business unit of Curtiss-Wright Flow Control Company
- Control Systems**
 - Air Monitor Corp.
 - Black & Veatch
 - Diakont
 - Emerson Process Management
 - Tecnomat, S.A.
 - Zachry Nuclear Engineering, Inc
- Control Systems: Automated**
 - HF Controls
- Control Systems: Class 1E**
 - AZZ / NLI
 - Diakont
 - DRS Consolidated Controls, Inc
 - HF Controls
 - Mirion Technologies
 - Nutherm International, Inc.
 - Scientech, a business unit of Curtiss-Wright Flow Control Company
- Control Systems: Computer-Assisted**
 - Diakont
- Control Systems: Safety**
 - Diakont
 - DRS Consolidated Controls, Inc
 - Mirion Technologies
 - Nutherm International, Inc.
- Controllers: Analog**
 - AZZ / NLI
 - Scientech, a business unit of Curtiss-Wright Flow Control Company
- Controllers: Flow**
 - AZZ / NLI
 - HI-Q Environmental Products Company
 - Rolls-Royce
- Controllers: Mass Flow**
 - AZZ / NLI
 - HI-Q Environmental Products Company
- Controllers: Pressure**
 - AZZ / NLI
 - VAT, INC.
- Controllers: Programmable**
 - AZZ / NLI
 - Scientech, a business unit of Curtiss-Wright Flow Control Company
- Controllers: Temperature**
 - AZZ / NLI
 - Nutherm International, Inc.
- Controllers: Vacuum**
 - VAT, INC.
- Converters: Safety-Related**
 - AZZ / NLI
 - Nutherm International, Inc.
 - Wyle Laboratories, Inc.
- Coolant Circulators**
 - Rolls-Royce
- Coolers: Containment**
 - AAF International
 - Aerofin
 - Ellis & Watts Global Industries, LLC.
 - Energy Steel & Supply CO.
 - Joseph Oat Corporation
 - Rolls-Royce
- Coolers: Cubicle Coolers**
 - AAF International
 - Ellis & Watts Global Industries, LLC.
 - Energy Steel & Supply CO.
- Coolers: Direct Expansion (DX) Refrigerant**
 - AZZ / NLI
 - Ellis & Watts Global Industries, LLC.
- Coolers: Drywell**
 - AAF International
 - Aerofin
 - Energy Steel & Supply CO.
- Coolers: Fan Coil Units**
 - AAF International
 - AZZ / NLI
 - Ellis & Watts Global Industries, LLC.
 - Energy Steel & Supply CO.
- Coolers: MCC**
 - Energy Steel & Supply CO.
- Cooling Systems: Forced Air**
 - AZZ / NLI
 - Ellis & Watts Global Industries, LLC.
- Cooling Systems: Personal**
 - Frham Safety Products, Inc.
- Cooling Towers**
 - Black & Veatch
 - The Shaw Group
- Cooling Water Intake Maintenance**
 - Underwater Construction Corporation
- Cooling Water Pipe**
 - Tioga Pipe Supply Company Inc.
- Core Shroud: Head Bolt Replacement**
 - Energy Steel & Supply CO.
- Corrosion Control**
 - Black & Veatch
 - Sargent & Lundy
- Corrosion Monitoring**
 - Structural Integrity Associates, Inc.
- Corrosion Testing Laboratory**
 - Kinectrics Incorporated
- Counters: Alpha/Beta**
 - Biodex Medical Systems, Inc.
- Counters: BF3**
 - Mirion Technologies
- Counters: Fission**
 - Mirion Technologies
- Counters: Gamma**
 - Biodex Medical Systems, Inc.
 - Mirion Technologies
- Counters: Radiation**
 - Biodex Medical Systems, Inc.
 - Mirion Technologies
- Counters: Wipe Test**
 - Biodex Medical Systems, Inc.
- Counting Systems: Proportional**
 - Mirion Technologies
- Counting Systems: Thyroid Uptake**
 - Biodex Medical Systems, Inc.
- Couplings: Quick-Connect**
 - Energy Steel & Supply CO.
 - Seal Master Corporation
- Coverings: Flame Retardant**
 - Reef Industries, Inc.
- Coverings: Temporary**
 - Reef Industries, Inc.
- Covers**
 - Energy Steel & Supply CO.
 - Euclid Garment Manufacturing Company
 - Reef Industries, Inc.
- Crane Control Systems**
 - American Crane & Equipment Corp.
 - Diakont
 - Konecranes Nuclear Equipment & Services LLC
 - PaR Systems, Inc.
- Crane Controls**
 - American Crane & Equipment Corp.
 - Diakont
 - Konecranes Nuclear Equipment & Services LLC

POWERFUL INNOVATION PROVEN EXPERIENCE



**Lifting Experts
for more than**

YEARS



**Your complete source for specialized
Nuclear Material Handling Solutions
for current plant needs and the next
generation of nuclear power plants.**

From complex custom equipment to standard equipment, components and parts, American Crane can meet all your material handling needs. Visit our new online catalogue at Store.AmericanCrane.com for comprehensive online parts and standard equipment featuring **Al-Vac, Yale, Shaw-Box, Budgit, Little Mule, CM, Chester Hoist, Coffing Hoist, Munck** and more.

SERVICES:

- ▶ Nuclear Quality Custom Equipment and Components (10 CFR 50 App. B & NQA-1)
- ▶ QA Program & Testing (10 CFR 50 App. B and NQA-1)
- ▶ Engineering Solutions including Seismic Analysis & Design
- ▶ In-House Manufacturing & Machining
- ▶ Installation, Site Services, Outage Services & Parts
- ▶ Upgrades & Rebuilds of Our Equipment & OEMs

YOUR CRITICAL LIFT EXPERTS

ACECO
 **American
CRANE**
& EQUIPMENT CORPORATION

877-877-6778, ext. 224 • AmericanCrane.com

Crane Retrofits

- American Crane & Equipment Corp.
Konecranes Nuclear Equipment & Services LLC
- Sciencetech, a business unit of Curtiss-Wright Flow Control Company
- Siempelkamp Nukleartechnik GmbH

Crane Retrofits: Single-Failure-Proof

- American Crane & Equipment Corp.
- Diakont
Konecranes Nuclear Equipment & Services LLC
PaR-KUT

Crane Service

- American Crane & Equipment Corp.
Barnhart
- Bigge Power Constructors
Hake Rigging Company
Konecranes Nuclear Equipment & Services LLC
PaR Systems, Inc.
PaR-KUT

Crane: Heavy Lifting for Plant Construction

- IHI Transport Machinery Co., Ltd

Crane: JIB

- IHI Transport Machinery Co., Ltd

Crane: Floating

- IHI Transport Machinery Co., Ltd

Cranes

- American Crane & Equipment Corp.
Black & Veatch
IHI Transport Machinery Co., Ltd
Konecranes Nuclear Equipment & Services LLC
- Rolls-Royce
- Sciencetech, a business unit of Curtiss-Wright Flow Control Company
- Siempelkamp Nukleartechnik GmbH

Cranes: Anti-Collision Systems

- American Crane & Equipment Corp.
Konecranes Nuclear Equipment & Services LLC

Cranes: Containment Polar

- American Crane & Equipment Corp.
Konecranes Nuclear Equipment & Services LLC
PaR-KUT
- Siempelkamp Nukleartechnik GmbH

Cranes: Electric

- American Crane & Equipment Corp.
Konecranes Nuclear Equipment & Services LLC

Cranes: Fuel Building (Cask Handling)

- American Crane & Equipment Corp.
Konecranes Nuclear Equipment & Services LLC
PaR-KUT
- Sciencetech, a business unit of Curtiss-Wright Flow Control Company
- Siempelkamp Nukleartechnik GmbH

Cranes: Fuel Pool

- American Crane & Equipment Corp.
- Diakont
Konecranes Nuclear Equipment & Services LLC
- Sciencetech, a business unit of Curtiss-Wright Flow Control Company
- Siempelkamp Nukleartechnik GmbH

Cranes: Gantry

- American Crane & Equipment Corp.
Konecranes Nuclear Equipment & Services LLC
- Siempelkamp Nukleartechnik GmbH

Cranes: Generically Licensable Type I

- American Crane & Equipment Corp.
Konecranes Nuclear Equipment & Services LLC

Cranes: Overhead

- American Crane & Equipment Corp.
Konecranes Nuclear Equipment & Services LLC
- Siempelkamp Nukleartechnik GmbH

Cranes: Radio Controls

- American Crane & Equipment Corp.
Del Mar Avionics
Konecranes Nuclear Equipment & Services LLC

Cranes: Radwaste

- American Crane & Equipment Corp.
Konecranes Nuclear Equipment & Services LLC
PaR Systems, Inc.
- Rolls-Royce
- Siempelkamp Nukleartechnik GmbH

Cranes: Safety System

- American Crane & Equipment Corp.
- Diakont
Konecranes Nuclear Equipment & Services LLC
- Siempelkamp Nukleartechnik GmbH

Cranes: Single-Failure-Proof

- American Crane & Equipment Corp.
- Bigge Power Constructors
Konecranes Nuclear Equipment & Services LLC
PaR-KUT

Cranes: Type I

- American Crane & Equipment Corp.
Konecranes Nuclear Equipment & Services LLC

Crushers: Drum

- S&G Enterprises, Inc.

Curing: Forced Air

- Fuel Tank Maintenance Company LLC

Cutting Equipment: Underwater

- Siempelkamp Nukleartechnik GmbH

Cutting: Underwater

- Advanced Consulting Group, Inc.
- Siempelkamp Nukleartechnik GmbH
Underwater Construction Corporation

Dampeners: Pulsation

- AT&F Nuclear, Inc., Division of AT & F
- Energy Steel & Supply CO.
Enertech, a business unit of Curtiss-Wright Flow Control Company
- Joseph Oat Corporation

Damper Operators

- AZZ / NLI
- Energy Steel & Supply CO.
Enertech, a business unit of Curtiss-Wright Flow Control Company
- SSM Industries, Inc.

Dampers: Backdraft

- AZZ / NLI
- Ellis & Watts Global Industries, LLC.
- Energy Steel & Supply CO.
- SSM Industries, Inc.

Dampers: Bubble Tight

- Ellis & Watts Global Industries, LLC.
- Energy Steel & Supply CO.
- SSM Industries, Inc.

Dampers: Control

- AZZ / NLI
- Ellis & Watts Global Industries, LLC.
- SSM Industries, Inc.

Dampers: Electric

- AZZ / NLI
- Ellis & Watts Global Industries, LLC.
- SSM Industries, Inc.

Dampers: Fire

- AZZ / NLI
- Ellis & Watts Global Industries, LLC.
- SSM Industries, Inc.

Dampers: Fire, Testing

- SSM Industries, Inc.

Dampers: High-Pressure

- AZZ / NLI
- Energy Steel & Supply CO.
- SSM Industries, Inc.

Dampers: Isolation

- AZZ / NLI
- Ellis & Watts Global Industries, LLC.
- SSM Industries, Inc.

Dampers: Manual

- SSM Industries, Inc.

Dampers: Pneumatic

- AZZ / NLI
- Ellis & Watts Global Industries, LLC.
- SSM Industries, Inc.

Dampers: Relief

- SSM Industries, Inc.

Dampers: Tornado

- Ellis & Watts Global Industries, LLC.
- SSM Industries, Inc.

Dampers: Volume

- SSM Industries, Inc.

Data Acquisition Systems

- Acromag, Inc.
- Analysis and Measurement Services Corp.
- Black & Veatch
- Zachry Nuclear Engineering, Inc

Data Management Systems

- Sargent & Lundy

Data Recorders

- AZZ / NLI

Data Recorders: Seismic Qualified

- AZZ / NLI
- Nuthern International, Inc.
- Wyle Laboratories, Inc.

Database Design/Development

- Fauske & Associates., LLC
- Sargent & Lundy
- Trust Manufacturing
- Zachry Nuclear Engineering, Inc

Database Services: Part Availability

- Platts UDI

DC Motors

- Peerless Electric

Decommissioning Services

- Advanced Consulting Group, Inc.
- Argonne National Laboratory
- Babcock Noell
- BHI Energy
- Bigge Power Constructors
- Black & Veatch
- Cutting Technologies
- Fauske & Associates., LLC
- Rolls-Royce
- Sargent & Lundy
- Siempelkamp Nukleartechnik GmbH
- Studsvik, Inc
- The Delphi Groupe, Inc.
- URS Corporation
- WMG, Inc.

Decontamination

- Rolls-Royce
- Schulz Electric Company
- Siempelkamp Nukleartechnik GmbH

Decontamination Chambers

- Siempelkamp Nukleartechnik GmbH

Decontamination Chemicals

- Siempelkamp Nukleartechnik GmbH

Decontamination Equipment

- BHI Energy
- Containter Products Corporation
- Gammasonics Institute for Medical Research
- LANCS Industries Holdings, LLC.
- Pentek, Inc.

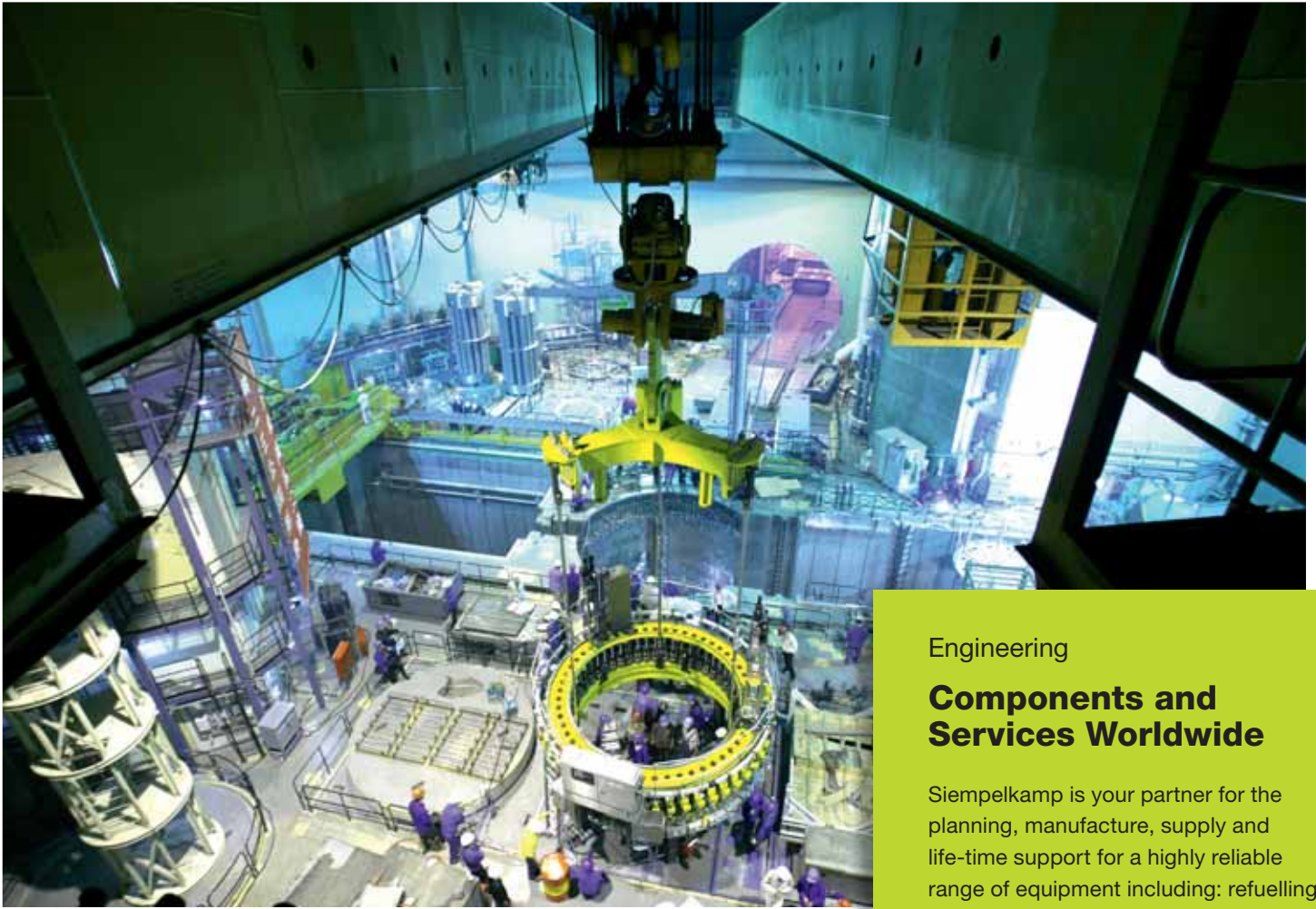

Engineering

Components and Services Worldwide

Siempelkamp is your partner for the planning, manufacture, supply and life-time support for a highly reliable range of equipment including: refuelling bridges, core internal and reactor head lifting devices, stud turning and tensioning tooling, cranes incl. polar, sealing heads, fuel element storage racks, core catcher cooling elements, waste handling facilities etc. for operating plants and new build.

Products and Services for Nuclear Power Plants

Compliance with the highest requirements in safety and quality in the nuclear sector is our business. We supply services, equipment and life-time support within the nuclear power industry. Our extensive know-how and experience over many years forms the basis for our successful delivery.

Get more information about our innovative nuclear technology:

John Mageski
T: 925.932.4000
C: 510.816.3762
john.mageski@siempelkamp.com

www.siempelkamp.com

Steve Garner
T: 803.796.2727
C: 803.422.1322
steve.garner@siempelkamp-sns.com

www.siempelkamp-sns.com



Siempelkamp

Nuclear Technology US



Siempelkamp

Nuclear Services

Tool and Metal Decontamination

Sensible - Cost-Effective - Convenient

- Tool, Scaffold, & Metal Decon
- Hot Equipment Offsite Storage
- Licensed Transport Services



High-pressure scaffold decontamination



Precise, automated monitoring for tube, planks, and clamps



Survey, storage, and inventory

Tool/equipment decontamination

- Offsite radioactive material decontamination at eleven facilities nationwide
- Process to free release motors, water tanks, drums, HVAC, tools, scrap metal, and lead
- Rad-controlled scaffold, tool, and equipment storage
- Nationwide truck fleet

ISO 9001

ISO 14001



USA Canada Germany UK The Netherlands
A subsidiary of UniFirst Corporation

(800) 344-3824 www.UniTechUS.com

- Rolls-Royce
- Siempelkamp Nukleartechnik GmbH

Decontamination Equipment (Cask)

- AT&F Nuclear, Inc, Division of AT & F Precision Custom Components, LLC
- Rolls-Royce
- Siempelkamp Nukleartechnik GmbH

Decontamination Equipment: Radioactive Gas

- NUCON International, Inc.
- Rolls-Royce

Decontamination Processes

- BHI Energy
- Kinectrics Incorporated
- Rolls-Royce
- Siempelkamp Nukleartechnik GmbH

Decontamination Services

- BHI Energy
- Fuel Tank Maintenance Company LLC
- Kinectrics Incorporated
- Schulz Electric Company
- Siempelkamp Nukleartechnik GmbH
- UniTech Services Group, Inc., Div. of Unifirst Corp.

Decontamination Services: Offsite

- Schulz Electric Company
- Studsvik, Inc
- UniTech Services Group, Inc., Div. of Unifirst Corp.

Decontamination Supplies

- Biodex Medical Systems, Inc.
- Frham Safety Products, Inc.
- Mohawk Industrial & Nuclear Supply, Inc.
- Reef Industries, Inc.
- UniTech Services Group, Inc., Div. of Unifirst Corp.

Decontamination: CO2

- Schulz Electric Company

Decontamination: Steel Equipment

- Rolls-Royce
- Westerman Nuclear

Dehumidifiers

Fuel Tank Maintenance Company LLC

Demineralization Equipment

Tri Nuclear Corporation

Design Basis Reconstitution

- Bechtel Power
- Fauske & Associates., LLC
- Sargent & Lundy
- URS Corporation
- Zachry Nuclear Engineering, Inc

Design Review

- Fauske & Associates., LLC
- Rolls-Royce

Design Services

- Bechtel Power
- Black & Veatch
- Design Engineering Analysis Corporation
- Joseph Oat Corporation
- RCM Technologies, Inc.
- Rolls-Royce
- Sargent & Lundy
- Scientech, a business unit of Curtiss-Wright Flow Control Company
- The Shaw Group
- URS Corporation
- Zachry Nuclear Engineering, Inc

Design: Computer System

- Rolls-Royce

Design: Computer-Aided

- Bechtel Power
- Rolls-Royce
- Siempelkamp Nukleartechnik GmbH

Design: Control Panel

- Rolls-Royce
- Schulz Electric Company
- Scientech, a business unit of Curtiss-Wright Flow Control Company

Design: Electrical

- Bechtel Power
- Energy Steel & Supply CO.
- Rolls-Royce
- Sargent & Lundy
- Scientech, a business unit of Curtiss-Wright Flow Control Company
- Zachry Nuclear Engineering, Inc

Design: Mechanical

- American Crane & Equipment Corp.
- Bechtel Power
- Energy Steel & Supply CO.
- Joseph Oat Corporation
- Rolls-Royce
- Sargent & Lundy
- Zachry Nuclear Engineering, Inc

Design: Process

- Rolls-Royce

Design: Seismic

- Bechtel Power
- Energy Steel & Supply CO.
- Fauske & Associates., LLC
- Joseph Oat Corporation
- Sargent & Lundy
- Zachry Nuclear Engineering, Inc

Design: Structural

- American Crane & Equipment Corp.
- Bechtel Power
- Energy Steel & Supply CO.
- Fauske & Associates., LLC
- Sargent & Lundy
- Zachry Nuclear Engineering, Inc

Destructive Testing

- Fauske & Associates., LLC

Detector Refurbishment

- Mirion Technologies

Detectors: BF3

- Mirion Technologies

Detectors: Combustible Gas

ENMET Corporation

Detectors: Ex-Core

- Mirion Technologies
- Thermo Scientific, NFMS Part of Thermo Fisher Scientific

Detectors: Gamma

- Biodex Medical Systems, Inc.
- Mirion Technologies
- Saint-Gobain Crystals
- Spectra Physics, Hilger Crystals Limited
- Thermo Scientific, NFMS Part of Thermo Fisher Scientific

Detectors: Gas

ENMET Corporation

Detectors: Gas, Area

- Draeger Safety.Inc.
- Mirion Technologies

Detectors: Gas, Personal

Draeger Safety.Inc.
ENMET Corporation

Detectors: Geiger-Muller

- Aware Electronics Corp.
- Gammasonics Institute for Medical Research
- Mirion Technologies

Detectors: In-Core

- Delta M Corporation
- Mirion Technologies

Detectors: Neutron

- Gammasonics Institute for Medical Research
- Mirion Technologies
- Thermo Scientific, NFMS Part of Thermo Fisher Scientific



CIVIL
GOVERNMENT SERVICES
MINING & METALS
OIL, GAS & CHEMICALS
POWER

Building the World's Energy Future

Bechtel is among the most respected engineering, procurement, and construction companies in the world. We stand apart for the ability to get the job done right—no matter how big, how complex, or how remote. Since 1898, we have completed more than 23,000 projects in 140 nations on all seven continents.



Detectors: Radiation

- Biodex Medical Systems, Inc.
- Dynasil Products
- Frham Safety Products, Inc.
- Gammasonics Institute for Medical Research
- Mirion Technologies
- ORTEC
- Saint-Gobain Crystals
- S-E International, Inc
- Spectra Physics, Hilger Crystals Limited

Detectors: Radiation, Gas-Filled

- Mirion Technologies

Detectors: Scintillation

- Biodex Medical Systems, Inc.
- Mirion Technologies
- Saint-Gobain Crystals
- Spectra Physics, Hilger Crystals Limited

Detergents: Contamination Removing

- Biodex Medical Systems, Inc.
- Chemetrics, Inc.

Dewatering & Drying

- Diversified Technologies Services, Inc.

Dewatering Services

- Fuel Tank Maintenance Company LLC
- Studsvik, Inc
- WMG, Inc.

Diagnostic Systems

- CORE, Inc.
- Enertech, a business unit of Curtiss-Wright
- Flow Control Company

Diagnostics

- Black & Veatch
- CORE, Inc.
- Energy Resources Group, Inc.

Diagnostics: Electric Machinery

- Schulz Electric Company

Diagnostics: Valve

- BHI Energy
- Valcor Engineering Corporation

Diagnostics: Valve Actuator

- Valcor Engineering Corporation

Diamond Wire Sawing

- Cutting Edge Services Corporation
- Cutting Technologies

Diaphragm Inspection

- Corrosion Control Services, Inc., CCSI Engineered Diaphragm Div

Diaphragm Installation

- Corrosion Control Services, Inc., CCSI Engineered Diaphragm Div

Diaphragm Maintenance

- Corrosion Control Services, Inc., CCSI Engineered Diaphragm Div

Diesel Engine Maintenance

- Fairbanks Morse Engine

Diesel Engines: Overhauling

- Fairbanks Morse Engine

Diesel Generator Engineering Studies

- Diakont
- Fairbanks Morse Engine
- Sargent & Lundy

Diesel Generators

- AZZ / NLI
- Fairbanks Morse Engine
- Western United Industries

Diesel Generators: Parts

- AZZ / NLI
- Diakont
- Energy Steel & Supply CO.
- Enertech, a business unit of Curtiss-Wright
- Flow Control Company
- Fairbanks Morse Engine
- Scientech, a business unit of Curtiss-Wright
- Flow Control Company
- Wyle Laboratories, Inc.

Diesel Generators: Repair

- Fairbanks Morse Engine
- Schulz Electric Company

Diesel Generators: Repair, Safety-Related

- Fairbanks Morse Engine
- Schulz Electric Company

Diesel Generators: Safety-Related

- AZZ / NLI
- Diakont
- Fairbanks Morse Engine

Display Systems

- AZZ / NLI

Distributor: OEM

- Energy Steel & Supply CO.
- Enertech, a business unit of Curtiss-Wright
- Flow Control Company
- Schulz Electric Company

Diving

- Underwater Construction Corporation

Document Conversions: Engineering

- Black & Veatch

Door Services

- Energy Steel & Supply CO.
- Pawling Engineered Products

Doors: Access

- Energy Steel & Supply CO.
- Pawling Engineered Products
- SSM Industries, Inc.

Doors: Blast

- Ellis & Watts Global Industries, LLC.
- Energy Steel & Supply CO.
- Oregon Iron Works, Inc
- Pawling Engineered Products

Doors: Bullet Proof

- AT&F Nuclear, Inc, Division of AT & F
- Energy Steel & Supply CO.
- Oregon Iron Works, Inc
- Pawling Engineered Products
- SSM Industries, Inc.

Doors: Manway

- Energy Steel & Supply CO.
- Oregon Iron Works, Inc
- Pawling Engineered Products

Doors: Marine

- Energy Steel & Supply CO.
- Oregon Iron Works, Inc
- Pawling Engineered Products
- SSM Industries, Inc.

Doors: Plenum

- Energy Steel & Supply CO.
- Oregon Iron Works, Inc
- Pawling Engineered Products
- SSM Industries, Inc.

Doors: Radiation Shielding

- AT&F Nuclear, Inc, Division of AT & F
- Ellis & Watts Global Industries, LLC.
- Energy Steel & Supply CO.
- Oregon Iron Works, Inc
- Pawling Engineered Products
- Precision Custom Components, LLC
- Rolls-Royce
- Siempelkamp Nukleartechnik GmbH
- SSM Industries, Inc.

Dosimeter Chargers

- Biodex Medical Systems, Inc.

Dosimeter Readers: Automatic Pocket

- Biodex Medical Systems, Inc.

Dosimeters: Direct Reading

- Biodex Medical Systems, Inc.

Dosimeters: Electronic Pocket

- Apantec LLC, North Penn Business Parrk
- Biodex Medical Systems, Inc.
- Mirion Technologies

Dosimeters: Electronic, Digital

- Mirion Technologies

Dosimeters: Personal

- Biodex Medical Systems, Inc.
- Frham Safety Products, Inc.
- Mirion Technologies

Dosimeters: Radiation

- Biodex Medical Systems, Inc.
- Frham Safety Products, Inc.
- Gammasonics Institute for Medical Research
- S-E International, Inc

Dosimetry Program Design

- Research Software Consulting Group, Inc.

Dosimetry Programs

- Research Software Consulting Group, Inc.

Dosimetry Services: TLD Badges

- Mirion Technologies

Dosimetry Supplies: TLD

- Mirion Technologies

Dosimetry Systems

- Gammasonics Institute for Medical Research
- Mirion Technologies
- Research Software Consulting Group, Inc.

Drafting Services

- Black & Veatch
- Rolls-Royce

Drafting: Computer-Aided

- HukariAscendent
- Rolls-Royce

Drafting: Electrical

- Rolls-Royce

Drafting: Manual

- Rolls-Royce

Drums: Polyethylene

- LANCS Industries Holdings, LLC.

Dry Fuel Storage

- GE Hitachi Nuclear Energy

Dryers: Microwave

- Linn High Therm GmbH

Dryers: Wet Solids

- Diversified Technologies Services, Inc.
- Linn High Therm GmbH
- Siempelkamp Nukleartechnik GmbH

Ductwork

- Energy Steel & Supply CO.
- SSM Industries, Inc.

Ductwork Hangers

- Energy Steel & Supply CO.
- SSM Industries, Inc.

Ductwork Supports

- Energy Steel & Supply CO.
- SSM Industries, Inc.

ECC (Emergency Core Cooling) Strainers

- Candu Energy Inc

ECP Monitors

- GE Hitachi Nuclear Energy

Eddy Current Test Standards

- Conco Systems, Inc.

Eddy Current Testing Services

- Conco Systems, Inc.
- EST Group, a business unit of Curtiss-Wright
- Flow Control Company
- Fauske & Associates., LLC

Electrical Equipment Services

- AZZ / NLI
- Rolls-Royce
- Schulz Electric Company

Electrical Master-Slave Manipulators

- American Crane & Equipment Corp.
- Siempelkamp Nukleartechnik GmbH

Electrical Panels: Air Conditioning

- AZZ / NLI

Electrical Panels: Control

- AZZ / NLI
- Nuthern International, Inc.

WE'LL KEEP THE LIGHTS ON FOR YOU

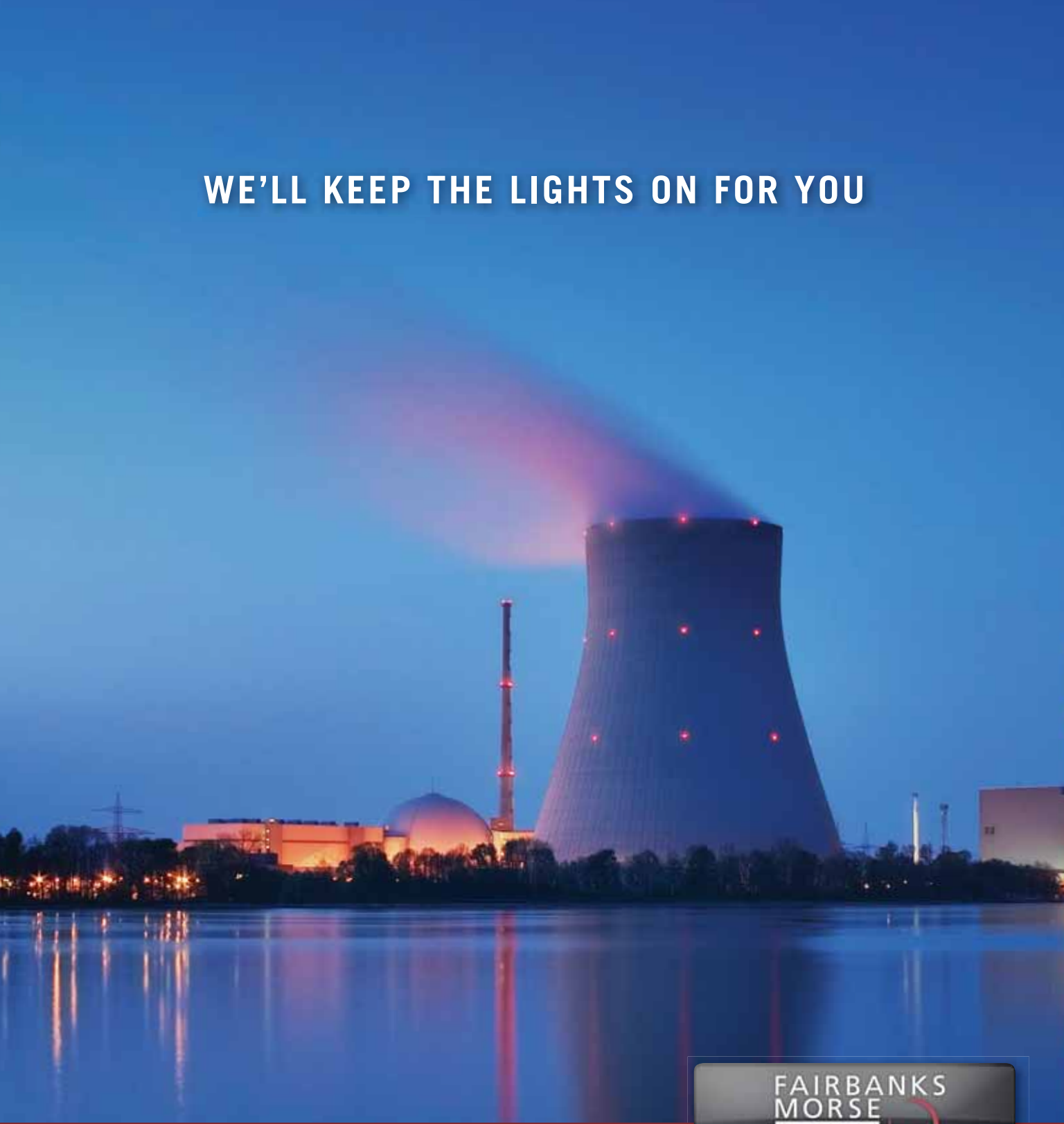

DIESEL GENERATOR SETS
The Proven Leader

www.fairbanksmorse.com

- Rolls-Royce
- Schulz Electric Company
- Westerman Nuclear

Electrodes: Welding

- Tioga Pipe Supply Company Inc.
- Weldstar

Electromechanical Assemblies

- Rolls-Royce

Electronic Components and Equipment

- American Crane & Equipment Corp.
- AZZ / NLI
- Rolls-Royce
- Scientech, a business unit of Curtiss-Wright
- Flow Control Company
- Siempelkamp Nukleartechnik GmbH

Emergency Planning

- HukariAscendent
- SAIC Canada
- Scientech, a business unit of Curtiss-Wright
- Flow Control Company

Emergency Preparedness Program Development

- Fauske & Associates., LLC
- Golder Associates Ltd.
- HukariAscendent
- SAIC Canada
- The Delphi Groupe, Inc.

Emergency Preparedness Program Evaluation

- Fauske & Associates., LLC
- HukariAscendent
- SAIC Canada

Emergency Preparedness: Exercises

- HukariAscendent
- SAIC Canada

Emergency Preparedness: Logistics Support

- HukariAscendent

Emergency Preparedness: Program Audits

- HukariAscendent

Emergency Preparedness: Staff Support

- BHI Energy
- HukariAscendent
- The Delphi Groupe, Inc.

Employment Services

- BHI Energy

Encapsulation Equipment

- Rolls-Royce

Enclosures: Metal

- Energy Steel & Supply CO.
- LANCS Industries Holdings, LLC.
- Rolls-Royce

Enclosures: Polycarbonate

- LANCS Industries Holdings, LLC.

Engineering Services

- American Crane & Equipment Corp.
- AREVA Inc.
- Bechtel Power
- BHI Energy
- Black & Veatch
- Candu Energy Inc
- Day & Zimmermann ECM
- Fauske & Associates., LLC
- HukariAscendent
- Hurst Technologies Corp..
- Joseph Oat Corporation
- Kinectrics Incorporated
- Novatech
- RCM Technologies, Inc.
- Rolls-Royce
- Sargent & Lundy
- Scientech, a business unit of Curtiss-Wright
- Flow Control Company
- Siempelkamp Nukleartechnik GmbH
- Structural Integrity Associates, Inc.
- Studsvik, Inc
- Tecnatom, S.A.
- Teledyne Brown Engineering, Inc.
- URS Corporation

- WorleyParsons Polestar
- Wyle Laboratories, Inc.
- Zachry Nuclear Engineering, Inc

Engineering Services: BWR

- Bechtel Power
- Black & Veatch
- Fauske & Associates., LLC
- GE Hitachi Nuclear Energy
- ILD, Inc.
- Sargent & Lundy
- Scientech, a business unit of Curtiss-Wright
- Flow Control Company
- Siempelkamp Nukleartechnik GmbH
- Structural Integrity Associates, Inc.
- Zachry Nuclear Engineering, Inc

Engineering Services: PWR

- Bechtel Power
- Black & Veatch
- Fauske & Associates., LLC
- ILD, Inc.
- Kinectrics Incorporated
- Sargent & Lundy
- Scientech, a business unit of Curtiss-Wright
- Flow Control Company
- Siempelkamp Nukleartechnik GmbH
- Structural Integrity Associates, Inc.
- Zachry Nuclear Engineering, Inc

Engineering Services: Underwater

- Siempelkamp Nukleartechnik GmbH

Engineering: Architectural

- Bechtel Power
- HukariAscendent

Engineering: Civil

- Bechtel Power
- Black & Veatch
- HukariAscendent
- Sargent & Lundy
- URS Corporation

Engineering: Computer Assisted

- Black & Veatch
- HukariAscendent
- Siempelkamp Nukleartechnik GmbH

Engineering: Control

- Black & Veatch
- Sargent & Lundy
- Zachry Nuclear Engineering, Inc

Engineering: Cost

- BHI Energy
- Sargent & Lundy

Engineering: Design

- Bechtel Power
- BHI Energy
- Black & Veatch
- Fauske & Associates., LLC
- HukariAscendent
- ILD, Inc.
- Joseph Oat Corporation
- Novatech
- Rolls-Royce
- Sargent & Lundy
- Scientech, a business unit of Curtiss-Wright
- Flow Control Company
- Siempelkamp Nukleartechnik GmbH
- The Delphi Groupe, Inc.
- The Shaw Group
- Zachry Nuclear Engineering, Inc

Engineering: Electrical

- American Crane & Equipment Corp.
- Bechtel Power
- Black & Veatch
- Carpency And Associates., LLC
- HukariAscendent
- Rolls-Royce
- Sargent & Lundy
- Scientech, a business unit of Curtiss-Wright
- Flow Control Company
- The Delphi Groupe, Inc.
- URS Corporation
- Zachry Nuclear Engineering, Inc

Engineering: Electronic

- Rolls-Royce
- Southwest Research Institute

Engineering: Engineered Controls, Design

- Enertech, a business unit of Curtiss-Wright
- Flow Control Company
- HukariAscendent
- URS Corporation

Engineering: Environmental

- Bechtel Power
- BHI Energy
- GEL Engineering LLC
- Golder Associates Ltd.
- HukariAscendent
- Sargent & Lundy

Engineering: Equipment

- American Crane & Equipment Corp.
- Fauske & Associates., LLC
- Rolls-Royce
- Siempelkamp Nukleartechnik GmbH

Engineering: Field

- Bechtel Power
- BHI Energy
- HukariAscendent

Engineering: Functional Cost Evaluation Value

- Rolls-Royce
- Siempelkamp Nukleartechnik GmbH

Engineering: Geotechnical

- Bechtel Power
- Black & Veatch
- Golder Associates Ltd.

Engineering: Human Factors

- Rolls-Royce

Engineering: Instrumentation

- Black & Veatch
- HukariAscendent
- Sargent & Lundy
- Zachry Nuclear Engineering, Inc

Engineering: Low-Level Waste Remediation

- Golder Associates Ltd.
- Rolls-Royce

Engineering: Maintenance

- CORE, Inc.
- HukariAscendent
- Sargent & Lundy

Engineering: Materials

- Joseph Oat Corporation
- Rolls-Royce
- Sargent & Lundy

Engineering: Mechanical

- American Crane & Equipment Corp.
- Bechtel Power
- BHI Energy
- Design Engineering Analysis Corporation
- HukariAscendent
- Joseph Oat Corporation
- Rolls-Royce
- Sargent & Lundy
- Scientech, a business unit of Curtiss-Wright
- Flow Control Company
- Structural Integrity Associates, Inc.
- The Delphi Groupe, Inc.
- URS Corporation
- Zachry Nuclear Engineering, Inc

Engineering: Metallurgical

- Structural Integrity Associates, Inc.

Engineering: Nuclear

- Bechtel Power
- BHI Energy
- Black & Veatch
- DCS Systems Inc.
- Fauske & Associates., LLC
- GE Hitachi Nuclear Energy
- Holtec International
- HukariAscendent
- Joseph Oat Corporation

WE MAKE METAL WORK™

THE EXPERIENCED AND RELIABLE SOURCE
FOR **NUCLEAR POWER PLANT COMPONENTS**



↑ A 316 stainless RHR Heat Exchanger



▲ Clean Room for the fabrication of components requiring physical segregation

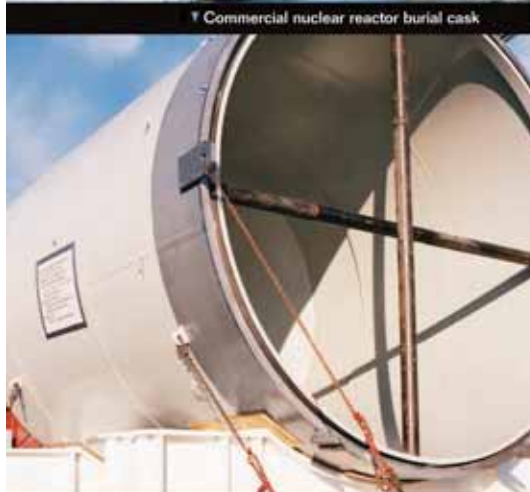

↑ Commercial nuclear reactor burial cask



▲ A titanium CCW Heat Exchanger

Over 100 power plants in 15 countries rely on Joseph Oat Corporation equipment.

- 35 continuous years of maintaining ASME SEC III CL. 1, 2 and 3 "N" stamp
- NUPIC audited
- Section III and safety-related heat exchangers & pressure vessels
- Plate fin air coolers
- Reverse engineering
- Pulsation dampeners
- Filters & Strainers
- Dry storage fabrication for spent fuel
- Yucca Mountain Waste Package Prototype
- MCOs, Model 9975s & other canisters
- Special weldments
- Heat transfer design services
- Seismic analysis
- Fatigue analysis
- Spare parts & miscellaneous materials



ESTABLISHED 1788

Joseph Oat Corporation

2500 Broadway
Camden, NJ 08104 USA
Voice: 856-541-2900
Fax: 856-541-0864
email: sales@josephoat.com
www.josephoat.com

Our **Quality Assurance Program** is qualified for ASME Section III Class 1, 2, 3, and MC, and Section VIII. It also conforms to 10CFR50 Appendix B, ANSI N45.2, NQA-1 and ISO 9001.



B/JAC

HTRI

HEAT TRANSFER RESEARCH, INC.

We also hold a Chinese Safety Quality License

- Rolls-Royce
 - Sargent & Lundy
 - Scientech, a business unit of Curtiss-Wright
- Flow Control Company
- Structural Integrity Associates, Inc.
 - WorleyParsons Polestar
 - Zachry Nuclear Engineering, Inc

Engineering: Pipe Supports

- Black & Veatch
- Fauske & Associates., LLC
- HukariAscendent
- Rolls-Royce

Engineering: Power Uprate

- Bechtel Power
- BHI Energy
- Fauske & Associates., LLC
- GE Hitachi Nuclear Energy
- HukariAscendent
- ILD, Inc.
- Sargent & Lundy
- URS Corporation
- Zachry Nuclear Engineering, Inc

Engineering: Quality

- BHI Energy
- HukariAscendent
- Rolls-Royce
- Zachry Nuclear Engineering, Inc

Engineering: Radiological

- Applied Analysis Corp.
- BHI Energy
- Rolls-Royce
- WMG, Inc.

Engineering: Start-Up

- Bechtel Power
- BHI Energy
- Fauske & Associates., LLC
- HukariAscendent
- Rolls-Royce

Engineering: Structural

- American Crane & Equipment Corp.
- Black & Veatch
- HukariAscendent
- Rolls-Royce
- Sargent & Lundy
- Structural Integrity Associates, Inc.
- URS Corporation
- Zachry Nuclear Engineering, Inc

Engineering: Systems

- BHI Energy
- Black & Veatch
- HukariAscendent
- ILD, Inc.
- Rolls-Royce
- Sargent & Lundy
- Teledyne Brown Engineering, Inc.
- Zachry Nuclear Engineering, Inc

Enrichment Services

- URENCO Ltd.

Enrichment: Uranium

- Wolfco, Inc.

Environmental Auditing

- S.M. Stoller Corp.

Environmental Impact Assessment

- Black & Veatch
- Golder Associates Ltd.
- S.M. Stoller Corp.
- URENCO Ltd.

Environmental Management

- BHI Energy
- HukariAscendent
- S.M. Stoller Corp.

Environmental Monitoring Equipment

- BHI Energy
- ENVINET GmbH
- HI-Q Environmental Products Company

Environmental Monitoring Services

- BHI Energy
- GEL Engineering LLC

Environmental Qual.: Service Water Systems

- Bechtel Power

Environmental Qualification

- AZZ / NLI
- Kinectrics Incorporated
- Nutherm International, Inc.
- RCM Technologies, Inc.
- Sargent & Lundy
- Schulz Electric Company
- Scientech, a business unit of Curtiss-Wright
- Flow Control Company
- Zachry Nuclear Engineering, Inc

Environmental Remediation

- BHI Energy
- Eberline Services Inc.
- Fuel Tank Maintenance Company LLC
- S.M. Stoller Corp.

Environmental Services

- Eberline Services Inc.
- GEL Engineering LLC

Environmental Test Chambers

- LANCS Industries Holdings, LLC.

Equipment & Services: Chromate Removal

- Diversified Technologies Services, Inc.

Equipment & Services: Reverse Osmosis

- Diversified Technologies Services, Inc.

Equipment & Services: Silica Removal

- Diversified Technologies Services, Inc.

Equipment Design

- American Crane & Equipment Corp.
- Black & Veatch
- Gammasonics Institute for Medical Research
- Joseph Oat Corporation
- Rolls-Royce

Equipment Management Systems

- CHAMPS Software, Inc.
- Rolls-Royce

Equipment Qualification

- AZZ / NLI
- Bechtel Power
- Fauske & Associates., LLC
- Kinectrics Incorporated
- Nutherm International, Inc.
- Oregon Iron Works, Inc
- Rolls-Royce
- Sargent & Lundy
- Schulz Electric Company
- Scientech, a business unit of Curtiss-Wright
- Flow Control Company
- Wyle Laboratories, Inc.

Equipment Qualification: Components, ASME

- AZZ / NLI
- Energy Steel & Supply CO.
- Fauske & Associates., LLC
- Kinectrics Incorporated
- Oregon Iron Works, Inc
- Rolls-Royce
- Scientech, a business unit of Curtiss-Wright
- Flow Control Company
- Valcor Engineering Corporation
- Westerman Nuclear

Equipment Reliability

- Scientech, a business unit of Curtiss-Wright
- Flow Control Company

Equipment Replacement

- Aquilex WSI Nuclear Services
- AZZ / NLI
- Black & Veatch
- Cutsforth
- Energy Steel & Supply CO.
- Rolls-Royce
- Schulz Electric Company

- Scientech, a business unit of Curtiss-Wright
- Flow Control Company
- Siempelkamp Nukleartechnik GmbH
- Westerman Nuclear
- Wyle Laboratories, Inc.

Equipment Take-aparts

- Rolls-Royce

Equipment: Bullet Resisting

- AT&F Nuclear, Inc, Division of AT & F

Equipment: Mechanical

- American Crane & Equipment Corp.
- American Crane & Equipment Corp.
- AZZ / NLI
- Rolls-Royce

Equipment: Safety-Related

- American Crane & Equipment Corp.
- AT&F Nuclear, Inc, Division of AT & F
- AZZ / NLI
- Draeger Safety.Inc.
- Enertech, a business unit of Curtiss-Wright
- Flow Control Company
- Joseph Oat Corporation
- Nutherm International, Inc.
- Penn Iron Works, Inc.
- Precision Custom Components, LLC
- Rolls-Royce
- Schulz Electric Company
- Scientech, a business unit of Curtiss-Wright
- Flow Control Company
- Siempelkamp Nukleartechnik GmbH
- SSM Industries, Inc.
- Westerman Nuclear
- Wyle Laboratories, Inc.

Evaluations: Supplier

- Siempelkamp Nukleartechnik GmbH

Evaporators

- Joseph Oat Corporation

Evaporators: Liquid Radwaste

- Oregon Iron Works, Inc
- Rolls-Royce

Examination: Visual

- Fauske & Associates., LLC

Exhibition Management

- "Atomexpo" LLC
- WM Symposia, Ste 9-332

Explosive Testing

- Fauske & Associates., LLC

Eye & Body Wash

- Frham Safety Products, Inc.

Eye/Face Protection

- Frham Safety Products, Inc.

Fabrication: Tubular Products

- AT&F Nuclear, Inc, Division of AT & F
- Energy Steel & Supply CO.
- Rolls-Royce
- Trust Manufacturing

Fabrications

- American Crane & Equipment Corp.
- AT&F Nuclear, Inc, Division of AT & F
- AZCO INC.
- AZZ / NLI
- Energy Steel & Supply CO.
- Greenberry Fabrication
- James C. White Company
- Joseph Oat Corporation
- Lincoln Structural Solutions (LSS Nuclear)
- Penn Iron Works, Inc.
- Precision Custom Components, LLC
- Rolls-Royce
- Scientech, a business unit of Curtiss-Wright
- Flow Control Company
- SSM Industries, Inc.
- Trust Manufacturing
- Westerman Nuclear

What commitment looks like



We are leaders in centrifuge technology and enrichment services. Over four decades, we have nurtured and constantly improved them.

We are committed to safety and dedicated to excellent customer service. Driven by growing customer demand, we have extended our global reach and now have four enrichment plants worldwide. Meeting customer requirements is key to our success and vital to ensure we maintain our reputation as supplier of choice.

By investing in the enrichment segment of the nuclear fuel supply chain we are fuelling the future – enabling the sustainable generation of electricity for consumers around the world.

www.urenco.com



Fabrications: Lead

Seafab Metal Company

Fabrics: Flame Retardant

Euclid Garment Manufacturing Company

Herculite Products

LANCS Industries Holdings, LLC.

Reef Industries, Inc.

- UniTech Services Group, Inc., Div. of Unifirst Corp.

Fabrics: Incinerable

Herculite Products

LANCS Industries Holdings, LLC.

Reef Industries, Inc.

Fabrics: Silica

LANCS Industries Holdings, LLC.

Failure Analysis

CORE, Inc.

Engineering Mechanics Corporation of Columbus

• Fauske & Associates., LLC

• Herguth Laboratories

• Kinectrics Incorporated

Laboratory Services

Laboratory Testing Inc.

• Rolls-Royce

Sargent & Lundy

• Schulz Electric Company

Southwest Research Institute

• Structural Integrity Associates, Inc.

Wyle Laboratories, Inc.

Failure Analysis: Electron Microscopy

• Herguth Laboratories

• Kinectrics Incorporated

Fans: Axial

• AZZ / NLI

• Ellis & Watts Global Industries, LLC.

• SSM Industries, Inc.

Stork H&E Turbo Blading

Fans: Centrifugal

• AZZ / NLI

• Ellis & Watts Global Industries, LLC.

• SSM Industries, Inc.

Fans: Exhaust

• Ellis & Watts Global Industries, LLC.

• SSM Industries, Inc.

Fans: High-Pressure

• Ellis & Watts Global Industries, LLC.

• SSM Industries, Inc.

Fans: Ventilating

• AZZ / NLI

• Ellis & Watts Global Industries, LLC.

• SSM Industries, Inc.

Fasteners

• Energy Steel & Supply CO.

Lincoln Structural Solutions (LSS Nuclear)

Niagara Fasteners Inc.

Superbolt Inc.

Tioga Pipe Supply Company Inc.

• Trust Manufacturing

• TW Metals - Nuclear Materials Solutions

Fasteners: Stud Tensioning

• Energy Steel & Supply CO.

• Siempelkamp Nukleartechnik GmbH

Superbolt Inc.

• Trust Manufacturing

Feeder Services

• Candu Energy Inc

Feedthroughs: Fiber-Optic

• Mirion Technologies

Feedwater Heaters

• Joseph Oat Corporation

• The Shaw Group

Fiber Optics

Rockbestos-Surprenant Cable Corporation

Weed Instrument Co., Inc d/b/a Ultra Electronics, NSPI

Fiberscopes: Rad Hardened

• Mirion Technologies

Field Service

AMETEK Programmable Power, Supporting Elgar Nuclear Equip.

Enertech, a business unit of Curtiss-Wright

Flow Control Company

• EST Group, a business unit of Curtiss-Wright

Flow Control Company

Flowsolve Flow Control Division

• GE Hitachi Nuclear Energy

• NUCON International, Inc.

Powerfect

• Schulz Electric Company

Wyle Laboratories, Inc.

Filter Cartridge

Enertech, a business unit of Curtiss-Wright

Flow Control Company

• Frham Safety Products, Inc.

• HI-Q Environmental Products Company

Filter Elements

• AAF International

Croll-Reynolds Engineering Company Inc.

• Energy Steel & Supply CO.



Call us for a quote or to request a copy of our Quality Assurance Manual

Contact sales@trustmfg.com

Call 216-531-8787
www.trustmfg.com
ASME QSC-594

TRUST
Manufacturing

20080 St Clair Avenue - Euclid, Ohio - 44117

Safety Related Fasteners • Nuts • Bolts • Studs • Alloy & Stainless Grades • Made to Order Specials

Enertech, a business unit of Curtiss-Wright
Flow Control Company
Mott Corporation

Filter Housings

- AAF International
- AZZ / NLI
- Ellis & Watts Global Industries, LLC.
- Energy Steel & Supply CO.
Enertech, a business unit of Curtiss-Wright
Flow Control Company
- HI-Q Environmental Products Company
- Ionex Research Corp.
- SSM Industries, Inc.
Tri Nuclear Corporation

Filter Media

- Diversified Technologies Services, Inc.
Enertech, a business unit of Curtiss-Wright
Flow Control Company
- F+J Specialty Products, Inc.
- HI-Q Environmental Products Company
Mott Corporation

Filter Paper

- F+J Specialty Products, Inc.
- Frham Safety Products, Inc.
- HI-Q Environmental Products Company

Filter Refills

- AAF International

Filter Systems

- AAF International
Enertech, a business unit of Curtiss-Wright
Flow Control Company
- Frham Safety Products, Inc.
New World Utility Services
- NUCON International, Inc.
- Rolls-Royce
Tri Nuclear Corporation

Filter Systems: Portable HEPA

- Frham Safety Products, Inc.
Ionex Research Corp.
- NUCON International, Inc.

Filter Test Equipment

- NUCON International, Inc.

Filter Testing

- NUCON International, Inc.

Filters

- AAF International
- Energy Steel & Supply CO.
Enertech, a business unit of Curtiss-Wright
Flow Control Company
- Joseph Oat Corporation
Mott Corporation
New World Utility Services
- Rolls-Royce
Tri Nuclear Corporation

Filters: Absolute Rated

- AAF International
New World Utility Services

Filters: Activated Carbon

- AAF International
F+J Specialty Products, Inc.
- HI-Q Environmental Products Company
- NUCON International, Inc.

Filters: Air

- AAF International
- Frham Safety Products, Inc.

Filters: Air Sampler

- F+J Specialty Products, Inc.
- Frham Safety Products, Inc.
- HI-Q Environmental Products Company
- Mirion Technologies
Staplex-Air Sampler Division

Filters: ASME Code

- AAF International
- Energy Steel & Supply CO.
Enertech, a business unit of Curtiss-Wright
Flow Control Company
Mechanical Equipment Company
- Rolls-Royce

HI-Q ENVIRONMENTAL PRODUCTS COMPANY, INC.
Air Sampling & Radiation Monitoring Equipment, Systems & Accessories

ANSI N13.1-2011 Stack Sampling Location Qualification Testing & System Design

Continuous Duty High & Low Volume Air Samplers

Health Physics & Radiation Measurement Instrumentation

Air Flow Calibrators

Mobile Cart Air Samplers

Filter Holders and Filter Media

7386 Trade Street
San Diego, CA 92121
Phone: 858-549-2820
Fax: 858-549-9657
Email: info@HI-Q.net
Internet: www.HI-Q.net

Providing Quality Solutions for the US Nuclear Market for Over 40 Years



Air Handler Unit



Normal Containment Cooler

- Filters
- Carbon Adsorbers
- Coils
- Bag In/Bag Out
- Air Handling Units
- Technical Support Centers
- Engineered Solutions
- Commercial Grade Dedication
- Fan Coolers/Containment Coolers
- Safety Related Replacement Parts

www.AAFINTL.com
nuclear@aafintl.com
502.637.0279

AmericanAirFilter

Filters: Automatic

- Energy Steel & Supply CO.
Enertech, a business unit of Curtiss-Wright Flow Control Company

Filters: Backwash

- Croll-Reynolds Engineering Company Inc.
- Energy Steel & Supply CO.
Enertech, a business unit of Curtiss-Wright Flow Control Company
- Mott Corporation

Filters: Bag

- AAF International

Filters: Charcoal

- AAF International
F+J Specialty Products, Inc.
- Frham Safety Products, Inc.
- NUCON International, Inc.

Filters: Chemical & Volume Control Systems

- Energy Steel & Supply CO.
Enertech, a business unit of Curtiss-Wright Flow Control Company

Filters: Compressed Gas

- Enertech, a business unit of Curtiss-Wright Flow Control Company

Filters: Condensate

- Energy Steel & Supply CO.
Enertech, a business unit of Curtiss-Wright Flow Control Company

Filters: Condensate Polishing

- Enertech, a business unit of Curtiss-Wright Flow Control Company
- Mott Corporation

Filters: Debris

- Enertech, a business unit of Curtiss-Wright Flow Control Company

Filters: Disposable

- AAF International

Filters: Duplex

- Energy Steel & Supply CO.
Enertech, a business unit of Curtiss-Wright Flow Control Company

Filters: Gas

- AAF International
Enertech, a business unit of Curtiss-Wright Flow Control Company
- Mott Corporation
- NUCON International, Inc.

Filters: HEPA

- AAF International
Blue Lake Products
- Frham Safety Products, Inc.
LANCS Industries Holdings, LLC.
- Rolls-Royce

Filters: Liquid

- Diversified Technologies Services, Inc.
- Energy Steel & Supply CO.
Enertech, a business unit of Curtiss-Wright Flow Control Company
- Mott Corporation
- Rolls-Royce
Tri Nuclear Corporation

Filters: Make-Up

- Enertech, a business unit of Curtiss-Wright Flow Control Company

Filters: Metal Mesh

- Energy Steel & Supply CO.
Enertech, a business unit of Curtiss-Wright Flow Control Company
- Rolls-Royce
Tri Nuclear Corporation

Filters: Micro

- Enertech, a business unit of Curtiss-Wright Flow Control Company
- Rolls-Royce

Filters: Oil

- Enertech, a business unit of Curtiss-Wright Flow Control Company

Filters: Pleated

- AAF International
Enertech, a business unit of Curtiss-Wright Flow Control Company

Filters: Porous Metal

- Enertech, a business unit of Curtiss-Wright Flow Control Company
- Mott Corporation

Filters: Precoat

- Croll-Reynolds Engineering Company Inc.
Enertech, a business unit of Curtiss-Wright Flow Control Company

Filters: Pressure

- Croll-Reynolds Engineering Company Inc.
- Energy Steel & Supply CO.
Enertech, a business unit of Curtiss-Wright Flow Control Company

Filters: Radwaste

- AAF International
- Energy Steel & Supply CO.
Enertech, a business unit of Curtiss-Wright Flow Control Company
- LANCS Industries Holdings, LLC.
- Rolls-Royce
Tri Nuclear Corporation

Filters: Reactor Containment Vent

- AAF International
- Energy Steel & Supply CO.
Ionex Research Corp.
- Rolls-Royce

Filters: Self-Cleaning

- Energy Steel & Supply CO.
Enertech, a business unit of Curtiss-Wright Flow Control Company

UNITED STATES POSTAL SERVICE
Statement of Ownership, Management, and Circulation (Requester Publications Only)

1. Publication Title: Nuclear Plant Journal
2. Publication Number: 0 8 9 2 - 2 0 5 5
3. Filing Date: 9/30/12
4. Issue Frequency: Bi-monthly
5. Number of Issues Published Annually: 6
6. Annual Subscription Price (If any): \$200
7. Complete Mailing Address of Known Office of Publication (Not printer) (Street, city, county, state, and ZIP+4®): 1400 Opus Place, Suite 904, Downers Grove, IL 60515
8. Complete Mailing Address of Headquarters or General Business Office of Publisher (Not printer): Same as above
9. Full Names and Complete Mailing Addresses of Publisher, Editor, and Managing Editor (Do not leave blank):
Publisher (Name and complete mailing address): Neval K. Agnihotri, 1400 Opus Place, Suite 904, Downers Grove, IL 60515
Editor (Name and complete mailing address): Same as above
Managing Editor (Name and complete mailing address): Same as above
10. Owner (Do not leave blank. If the publication is owned by a corporation, give the name and address of the corporation immediately followed by the names and addresses of all stockholders owning or holding 1 percent or more of the total amount of stock. If not owned by a corporation, give the names and addresses of the individual owners. If owned by a partnership or other unincorporated firm, give its name and address as well as those of each individual owner. If the publication is published by a nonprofit organization, give its name and address.):
Full Name: Neval K. Agnihotri
Complete Mailing Address: 1400 Opus Place, Suite 904, Downers Grove, IL 60515
11. Known Bondholders, Mortgagees, and Other Security Holders Owning or Holding 1 Percent or More of Total Amount of Bonds, Mortgages, or Other Securities. If none, check box: None
Full Name:
Complete Mailing Address:
12. Tax Status (For completion by nonprofit organizations authorized to mail at nonprofit rates) (Check one)
 Has Not Changed During Preceding 12 Months
 Has Changed During Preceding 12 Months (Publisher must submit explanation of change with this statement)

PS Form 3526-R, August 2012 (Page 1 of 3 (Instructions Page 3)) PSN: 7520-06-000-8803 PRIVACY NOTICE: See our privacy policy on www.usps.com.

13. Publication Title: Nuclear Plant Journal
14. Issue Date for Circulation Data Below: Sept/Oct 2012
15. Extent and Nature of Circulation:
a. Total Number of Copies (Net press run): 11,173
b. Legitimate Paid and/or Requested Distribution (By Mail and Outside the Mail):
(1) Outside County Paid/Requested Mail Subscriptions stated on PS Form 3541: 6,297
(2) In-County Paid/Requested Mail Subscriptions stated on PS Form 3541: 575
(3) Sales Through Dealers and Carriers, Street Vendors, Counter Sales, and Other Paid or Requested Distribution Outside USPS®: 567
(4) Requested Copies Distributed by Other Mail Classes Through the USPS (e.g., First-Class Mail®): 6,697
c. Total Paid and/or Requested Circulation (Sum of 15b (1), (2), (3), and (4)): 6,872
d. Non-requested Distribution (Sum of 15d (1), (2), (3) and (4)):
(1) Outside County Nonrequested Copies Stated on PS Form 3541 (include Sample copies, Requests Over 3 years old, Requests induced by a Premium, Bulk Sales and Requests including Association Requests, Names obtained from Business Directories, Lists, and other sources): 3,900
(2) In-County Nonrequested Copies Stated on PS Form 3541 (include Sample copies, Requests Over 3 years old, Requests induced by a Premium, Bulk Sales and Requests including Association Requests, Names obtained from Business Directories, Lists, and other sources): 137
(3) Nonrequested Copies Distributed Through the USPS by Other Classes of Mail (e.g., First-Class Mail, Nonrequester Copies mailed in excess of 10% Limit mailed at Standard Mail® or Package Services Station): 50
(4) Nonrequested Copies Distributed Outside the Mail (includes Pickup Stands, Trade Shows, Showrooms, and Other Sources): 50
e. Total Nonrequested Distribution (Sum of 15d (1), (2), (3) and (4)): 4,037
f. Total Distribution (Sum of 15c and e): 10,909
g. Copies not Distributed (See instructions to Publishers #4, (page #3)): 264
h. Total (Sum of 15f and g): 11,173
i. Percent Paid and/or Requested Circulation (15c divided by 15h times 100): 63.00%
16. Total circulation includes electronic copies. Report circulation on PS Form 3526-X worksheet. 63,00%
17. Publication of Statement of Ownership for a Requester Publication is required and will be printed in the issue of this publication. Nov/Dec 2012
18. Signature and Title of Editor, Publisher, Business Manager, or Owner: [Signature] Date: 9/28/2012
I certify that all information furnished on this form is true and complete. I understand that anyone who furnishes false or misleading information on this form or who omits material or information requested on the form may be subject to criminal sanctions (including fines and imprisonment) and/or civil sanctions (including civil penalties).

PS Form 3526-R, August 2012 (Page 2 of 3)

Filters: Sintered Metal Fiber

- Enertech, a business unit of Curtiss-Wright
- Flow Control Company
- Mott Corporation

Filters: Tubular Element

- Energy Steel & Supply CO.
- Enertech, a business unit of Curtiss-Wright
- Flow Control Company

Filters: Underwater

- Diversified Technologies Services, Inc.
- Enertech, a business unit of Curtiss-Wright
- Flow Control Company
- Tri Nuclear Corporation

Filters: Waste Drum Vent

- LANCS Industries Holdings, LLC.

Filtration

- Enertech, a business unit of Curtiss-Wright
- Flow Control Company
- Fuel Tank Maintenance Company LLC
- Mott Corporation
- New World Utility Services
- Rolls-Royce
- Tri Nuclear Corporation

Filtration Equipment

- AAF International
- Energy Steel & Supply CO.
- Enertech, a business unit of Curtiss-Wright
- Flow Control Company
- Mott Corporation
- New World Utility Services
- NUCON International, Inc.
- Rolls-Royce
- SSM Industries, Inc.
- Tri Nuclear Corporation

Filtration Media: Carbon

- AAF International
- HI-Q Environmental Products Company
- NUCON International, Inc.

Finite Element Analysis

- GE Hitachi Nuclear Energy

Fire Proofing Materials

- Lonza Wood Protection

Fire Protection

- Black & Veatch
- Frham Safety Products, Inc.
- Fuel Tank Maintenance Company LLC
- HukariAscendent
- Transco Products Inc.
- Zachry Nuclear Engineering, Inc

Fire Protection Data Systems

- HukariAscendent

Fire Protection: Electrical Systems

- Euclid Garment Manufacturing Company
- HukariAscendent

First Aid: Supplies & Equipment

- Frham Safety Products, Inc.

Fittings

- AZZ / NLI
- Energy Steel & Supply CO.
- Newage Industries, Inc.
- Tioga Pipe Supply Company Inc.
- Trust Manufacturing
- TW Metals - Nuclear Materials Solutions

Fittings: Flow Control

- Energy Steel & Supply CO.

Fittings: Vacuum

- Energy Steel & Supply CO.

Fittings: Welding

- Energy Steel & Supply CO.
- Trust Manufacturing
- Westerman Nuclear

Flanges

- Energy Steel & Supply CO.
- Tioga Pipe Supply Company Inc.
- Trust Manufacturing
- TW Metals - Nuclear Materials Solutions

Flasks: Storage, Design and Testing

- Oregon Iron Works, Inc
- Rolls-Royce

Flasks: Transport, Design and Testing

- Oregon Iron Works, Inc
- Rolls-Royce

Flow Measurement Services

- Air Monitor Corp.
- F+J Specialty Products, Inc.
- Fauske & Associates., LLC

Flowmeters

- Air Liquide America Specialty Gases, LLC
- AZZ / NLI
- Energy Steel & Supply CO.
- F+J Specialty Products, Inc.
- Fluid Components International (FCI)
- HI-Q Environmental Products Company

Flowmeters: Mass

- AZZ / NLI
- Fluid Components International (FCI)
- HI-Q Environmental Products Company

Flowmeters: Ultrasonic, Multipath

- AZZ / NLI

Flowmeters: Ultrasonic, Multipipe

- AZZ / NLI

Flux: Welding

- Energy Steel & Supply CO.

Foil: Lead

- Biodex Medical Systems, Inc.
- LANCS Industries Holdings, LLC.

Forging Copper

- Trust Manufacturing
- TW Metals - Nuclear Materials Solutions

Forging Copper Alloy

- Trust Manufacturing
- TW Metals - Nuclear Materials Solutions

Forgings

- Tioga Pipe Supply Company Inc.
- Trust Manufacturing
- TW Metals - Nuclear Materials Solutions

Forgings: Open Die

- Trust Manufacturing

Foundation Design & Analysis

- Sargent & Lundy
- The Shaw Group

Fuel

- AREVA Inc.

Fuel Analysis

- Candu Energy Inc
- DCS Systems Inc.

Fuel Analysis: BWR

- GE Hitachi Nuclear Energy

Fuel Assemblies

- Cameco Fuel Manufacturing Inc.

Fuel Assembly Grids

- Oregon Iron Works, Inc

Fuel Assembly Nozzles

- Oregon Iron Works, Inc

Fuel Casks: Barge

- Oregon Iron Works, Inc
- Precision Custom Components, LLC
- Rolls-Royce

Fuel Casks: Rail

- Oregon Iron Works, Inc
- Precision Custom Components, LLC
- Rolls-Royce

Fuel Channels

- Candu Energy Inc
- Kinectrics Incorporated

Fuel Cycle Analysis

- GE Hitachi Nuclear Energy

Fuel Cycle Management

- Utility Resource Associates

Fuel Design

- DCS Systems Inc.

Fuel Fabrication

- Cameco Fuel Manufacturing Inc.
- DCS Systems Inc.
- GE Hitachi Nuclear Energy

Fuel Floor Support

- Oregon Iron Works, Inc
- Underwater Construction Corporation

Fuel Handling Equipment

- American Crane & Equipment Corp.
- Candu Energy Inc
- Diakont
- Konecranes Nuclear Equipment & Services LLC
- Oregon Iron Works, Inc
- Precision Custom Components, LLC
- Rolls-Royce
- Scientech, a business unit of Curtiss-Wright
- Flow Control Company
- Siempelkamp Nukleartechnik GmbH

Fuel Inspection

- Candu Energy Inc

Fuel Management

- DCS Systems Inc.
- Howard L. Sobel, P.E.
- Standish Technologies, International

Fuel Pool Auxiliary Cooling

- Fauske & Associates., LLC

Fuel Pool Cleanup

- Tri Nuclear Corporation

Fuel Pool Equipment

- American Crane & Equipment Corp.
- BIRNS, Inc.
- Diakont
- Oregon Iron Works, Inc
- Rolls-Royce

Fuel Pool Liners

- Babcock Noell
- Oregon Iron Works, Inc

Fuel Positioning Systems

- Diakont

Fuel Reconstitution

- Siempelkamp Nukleartechnik GmbH

Fuel Repair

- Siempelkamp Nukleartechnik GmbH

Fuel Reprocessing Equipment

- Precision Custom Components, LLC
- Rolls-Royce

Fuel Storage Facilities

- Precision Custom Components, LLC
- URS Corporation

Fuel Storage Racks

- Energy Steel & Supply CO.
- Oregon Iron Works, Inc
- Precision Custom Components, LLC
- Rolls-Royce
- Siempelkamp Nukleartechnik GmbH

Fuel Transfer System Maintenance

- American Crane & Equipment Corp.
- Diakont
- Rolls-Royce

Fuel Transfer Systems

- American Crane & Equipment Corp.
- Diakont
- Energy Steel & Supply CO.
- Oregon Iron Works, Inc
- Rolls-Royce
- Scientech, a business unit of Curtiss-Wright
- Flow Control Company
- Underwater Construction Corporation

Fuel Transport Services

- Rolls-Royce



Annual Editorial Schedule

January-February
International Trade & Waste & Fuel Management

March-April
Plant Maintenance & Plant Life Extension

May-June
Outage Mgmt. & Health Physics

July-August
New Plants & Vendor Advertorial

September-October
Plant Maintenance & Advanced Reactors

November-December
Annual Product & Service Directory



Mohawk Safety

Your On-Line
Nuclear Safety Checklist!

- Health Physics & Decon Supplies
- Test Wipe Smears & Filter Paper
- Anti-C Gloves & Shoecovers
- Lead Shielding
- Bags, Tubing & Sleeving
- Signs, Labels & Tapes
- Containment Chambers & Tents
- Anti-C Clothing

Free Catalog Upon Request!

Call 800-394-6853 or
Order On-line!

5 Glen Road, Manchester, CT 06040
MohawkSafety.com

Fuel: Spent, Transport

- American Crane & Equipment Corp.
- Energy Steel & Supply CO.

Fuel: Transport Flasks

- American Crane & Equipment Corp.
- Precision Custom Components, LLC

Fuse Holders: Safety-Related

- AZZ / NLI
- Nutherm International, Inc.
- Wyle Laboratories, Inc.

Fuses: Safety-Related

- AZZ / NLI
- Nutherm International, Inc.
- Wyle Laboratories, Inc.

Gases: Specialty

- Air Liquide America Specialty Gases, LLC

Gaskets: Radiation Resistant

- Seal Master Corporation

Gauges: Pressure

- AZZ / NLI
- Nutherm International, Inc.

Gauges: Vacuum

- AZZ / NLI

Generator Inspection

- Schulz Electric Company

Generators

- Rolls-Royce
- The Shaw Group
- Western United Industries

Glove Bags

- Frham Safety Products, Inc.
- LANCS Industries Holdings, LLC.

Glove Boxes

- AT&F Nuclear, Inc, Division of AT & F
- Energy Steel & Supply CO.
- Frham Safety Products, Inc.
- LANCS Industries Holdings, LLC.
- Precision Custom Components, LLC
- Rolls-Royce
- SSM Industries, Inc.
- Walischmiller Engineering GmbH

Gloves: Protective

- Biodex Medical Systems, Inc.
- Euclid Garment Manufacturing Company
- Frham Safety Products, Inc.
- UniTech Services Group, Inc., Div. of Unifirst Corp.

Grating

- Energy Steel & Supply CO.
- McNichols Company

Grease Analysis

- Herguth Laboratories
- R&G Laboratories, Inc.

Grit Blasting

- Schulz Electric Company
- UniTech Services Group, Inc., Div. of Unifirst Corp.

Hazard Analysis

- Fauske & Associates., LLC

Headers

- Energy Steel & Supply CO.

Health & Safety Services

- HukariAscendent

Health Physics

- Apantec LLC, North Penn Business Park
- BHI Energy
- LANCS Industries Holdings, LLC.
- Pacific Radiation Corporation
- The Delphi Groupe, Inc.

Health Physics Services

- Bevelacqua Resources
- BHI Energy
- DADE Moeller & Associated, Inc.
- Eberline Services Inc.
- Pacific Radiation Corporation

Health Physics Supplies

- Euclid Garment Manufacturing Company
- Frham Safety Products, Inc.
- HI-Q Environmental Products Company
- LANCS Industries Holdings, LLC.
- Mohawk Industrial & Nuclear Supply, Inc.
- UniTech Services Group, Inc., Div. of Unifirst Corp.

Hearing Protection

- Frham Safety Products, Inc.

Heat Decay Studies

- Black & Veatch

Heat Exchanger Analysis/Inspection Services

- Conco Systems, Inc.
- Energy Steel & Supply CO.
- EST Group, a business unit of Curtiss-Wright Flow Control Company
- Joseph Oat Corporation
- Powerfect
- Rolls-Royce
- Structural Integrity Associates, Inc.
- Zachry Nuclear Engineering, Inc.

Heat Exchanger Maintenance

- BHI Energy
- Conco Systems, Inc.
- Energy Steel & Supply CO.
- EST Group, a business unit of Curtiss-Wright Flow Control Company
- Heat Exchanger Products Corp.
- Plastacor, Inc.
- Powerfect
- Rolls-Royce

Heat Exchanger Tube Cleaning

- Conco Systems, Inc.
- Energy Steel & Supply CO.
- EST Group, a business unit of Curtiss-Wright Flow Control Company
- Powerfect

Heat Exchanger: Chemical Cleaning

- Energy Steel & Supply CO.

Heat Exchangers

- Aerofin
- AT&F Nuclear, Inc, Division of AT & F
- AZZ / NLI
- Black & Veatch
- Ellis & Watts Global Industries, LLC.
- Energy Steel & Supply CO.
- Greenberry Fabrication
- Holtec International
- Joseph Oat Corporation
- Lytron
- Mechanical Equipment Company
- Oregon Iron Works, Inc
- Precision Custom Components, LLC
- Rolls-Royce
- Sentry Equipment Corp
- The Shaw Group
- Thermal Engineering International (USA)
- Westerman Nuclear

Heat Exchangers: Rebuilding

- AeroFin
- Energy Steel & Supply CO.
- Joseph Oat Corporation
Powerfect

Heat Exchangers: Retubing

- Energy Steel & Supply CO.
- EST Group, a business unit of Curtiss-Wright
Flow Control Company

Heat Exchangers: Shell

- AeroFin
- Energy Steel & Supply CO.
- Joseph Oat Corporation
- Oregon Iron Works, Inc
- Penn Iron Works, Inc.
- Sentry Equipment Corp
- Westerman Nuclear

Heat Exchangers: Spray Integrity Testing

- Energy Steel & Supply CO.

Heat Exchangers: Studies

- Black & Veatch
- Joseph Oat Corporation
- Zachry Nuclear Engineering, Inc

Heat Exchangers: Tubes

- AZZ / NLI
- Energy Steel & Supply CO.
- Lytron
- TW Metals - Nuclear Materials Solutions
- Westerman Nuclear

Heat Tracing Systems

- AZZ / NLI
- Energy Steel & Supply CO.

Heaters: Electric

- Ellis & Watts Global Industries, LLC.
- Energy Steel & Supply CO.
- Enertech, a business unit of Curtiss-Wright
Flow Control Company
- Linn High Therm GmbH
- Nutherm International, Inc.

Heaters: Hot Water

- Ellis & Watts Global Industries, LLC.
- Energy Steel & Supply CO.
- Enertech, a business unit of Curtiss-Wright
Flow Control Company

Heaters: Space

- Energy Steel & Supply CO.
- Enertech, a business unit of Curtiss-Wright
Flow Control Company

Heating Equipment: Electric Resistance

- Energy Steel & Supply CO.
- Enertech, a business unit of Curtiss-Wright
Flow Control Company
- Linn High Therm GmbH

Heating Equipment: Induction

- Energy Steel & Supply CO.
- Enertech, a business unit of Curtiss-Wright
Flow Control Company
- Hydratight
- Linn High Therm GmbH

Hoists

- American Crane & Equipment Corp.
- Black & Veatch
- Del Mar Avionics
- Konecranes Nuclear Equipment & Services
LLC
- Scientech, a business unit of Curtiss-Wright
Flow Control Company

Hoists: Radio Controls

- American Crane & Equipment Corp.
- Konecranes Nuclear Equipment & Services
LLC

Hoods: Respirator

- Euclid Garment Manufacturing Company
- LANCS Industries Holdings, LLC.
- UniTech Services Group, Inc., Div. of Unifirst
Corp.

Hose

- LANCS Industries Holdings, LLC.
- Seal Master Corporation

Hose Assemblies: Metal

- AZZ / NLI
- Energy Steel & Supply CO.

Hot Cells

- Babcock Noell
- Oregon Iron Works, Inc
- Siempelkamp Nukleartechnik GmbH
- Steventon Stewart International Inc.
- Walischmiller Engineering GmbH

Housings: Filter

- AAF International
- Ellis & Watts Global Industries, LLC.
- Energy Steel & Supply CO.
- SSM Industries, Inc.
- Tri Nuclear Corporation

Humidity Measuring Equipment

- Elan Technical Corporation

HVAC Construction

- SSM Industries, Inc.

HVAC Systems

- AZZ / NLI
- Black & Veatch
- Ellis & Watts Global Industries, LLC.
- Sargent & Lundy
- SSM Industries, Inc.

HVAC Systems: Acceptance Testing

- Jacox Associates
- NUCON International, Inc.

HVAC Systems: AG-1 Testing

- Jacox Associates
- NUCON International, Inc.
- SSM Industries, Inc.

Safety Related Coils and Heat Exchangers

AEROFIN is Your Source for
Safety Related & Non-Safety
Related Components

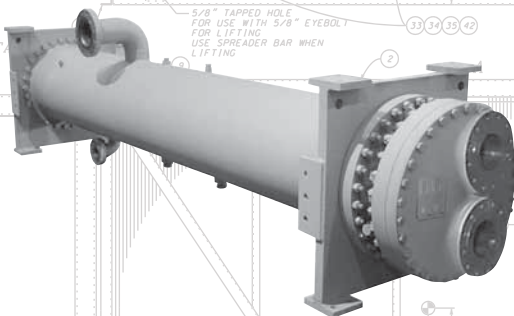

- Cooling & Heating Coils
- Shell & Tube Heat Exchangers
- Pressure Vessels
- Air Accumulator Tanks
- Pressurizer Sample Coolers
- Lube Oil Coolers
- Transformer Oil Coolers
- Piping Subassemblies
- Specialty Fabricated Parts
- Evaporators & Condensers
- Automatic Water Strainers
- Pumps (Class 2 & 3)

AEROFIN is fully accredited
to meet your nuclear
equipment needs.

- NUPIC audited
- 10CFR50 Appendix B
- 10CFR21 Reportability
- ASME NQA-1 / NCA-4000
- ASME III (Class 1, 2 & 3)
- ASME VIII
- ASME AG-1 CONAGT
- Reverse Engineering

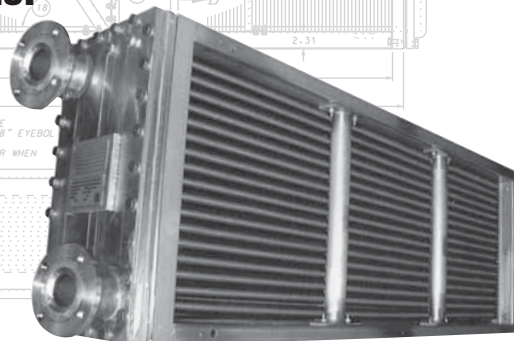

4621 Murray Place (24502) • P.O. Box 10819
Lynchburg, VA 24506-0819
Phone: 434-845-7081 • Fax: 434-528-6281
www.aerofin.com • Phone Toll Free: 1-800-237-6346

AEROFIN
Heat Transfer Products

**SUPPLYING HVAC EQUIPMENT
TO THE
NUCLEAR INDUSTRY
FOR OVER 40 YEARS
Experience & Integrity**



INDUSTRIES, INC.
POWER DIVISION
Formerly Schneider Sheet Metal

Complete HVAC Product Line From Fan to Diffuser

**Fans, VFDs, Air Handling Units,
Hepa Filter Housings, Charcoal
Adsorbers, Dampers (Bubbletight,
HELB, Tornado, Control,
Variable Inlet, Backdraft, Balancing,
Fire & Smoke) Duct & Accessories
(Supports, Access Doors, Flex
Connections, etc.) Actuators,
Instruments & Controls,
Grilles, Registers & Diffusers**

Services

Installation, Testing,
Field Engineers,
Product Design

**All Products are designed,
qualified & fabricated in
accordance with
ASME AG-1 & NQA-1**

SSM Industries Inc.
3401 Grand Ave. Pittsburgh
PA 15225-1507
Phone: (412) 777-5101
www.ssmi.biz
Email powerdiv@ssmi.biz

HVAC Systems: Installation

- SSM Industries, Inc.

HVAC Systems: Start-Up Testing

- NUCON International, Inc.

HVAC Systems: Testing

- EST Group, a business unit of Curtiss-Wright
Flow Control Company
- NUCON International, Inc.

HVAC: Ventilation Equipment

- AAF International
- AZZ / NLI
BHI Energy
- Ellis & Watts Global Industries, LLC.
- SSM Industries, Inc.

Hydraulic Manipulators

- Del Mar Avionics

Hydraulic Slewing

- EST Group, a business unit of Curtiss-Wright
Flow Control Company

Hydrogen Recombiners

- Candu Energy Inc
Enertech, a business unit of Curtiss-Wright
Flow Control Company
- Fauske & Associates., LLC

I/O Controllers

- Scientech, a business unit of Curtiss-Wright
Flow Control Company

I/O Systems: Distributed

- Acromag, Inc.
Black & Veatch

Image Intensifier: Neutron

- Thermo Scientific-CIDTEC, (Part of Thermo
Fisher Scientific)

Image Recognition Systems

- Diakont
- Mirion Technologies

Imaging Systems

- Diakont
- Dynasil Products
- Thermo Scientific-CIDTEC, (Part of Thermo
Fisher Scientific)

Indicator Lights: Safety-Related

- Nutherm International, Inc.
Wyle Laboratories, Inc.

Indicators

- AZZ / NLI
- Scientech, a business unit of Curtiss-Wright
Flow Control Company

Indicators: Panel Mounted

- AZZ / NLI
Wyle Laboratories, Inc.

Industrial Applications of Neutron Techniques

- Rogante Engineering Office

Industrial Hygiene Services

- DADE Moeller & Associated, Inc.
GEL Engineering LLC
Golder Associates Ltd.

Inflatable Seals

- Candu Energy Inc

Information Management Systems

- Black & Veatch
Sargent & Lundy

Information Services

- Scientech, a business unit of Curtiss-Wright
Flow Control Company

Information Services: Equipment Qualification

- Fauske & Associates., LLC
Nutherm International, Inc.
- Scientech, a business unit of Curtiss-Wright
Flow Control Company
Wyle Laboratories, Inc.

Infrared Surveys: Electrical

- Schulz Electric Company

Inspection

- American Crane & Equipment Corp.
- Hukari Ascendent
- Structural Integrity Associates, Inc.
- The Shaw Group

Inspection Equipment: Development

- Diakont
- Kinectrics Incorporated
- Rolls-Royce
- Tecnatom, S.A.
- Thermo Scientific-CIDTEC, (Part of Thermo
Fisher Scientific)

Inspection Equipment: Robotic

- Candu Energy Inc
- Diakont
- iRobot Corporation
R.O.V. Technologies, Inc.
- Rolls-Royce
- Tecnatom, S.A.

Inspection Equipment: Visual

- Candu Energy Inc
- Diakont
- Mirion Technologies
- Rolls-Royce
- Tecnatom, S.A.
- Thermo Scientific-CIDTEC, (Part of Thermo
Fisher Scientific)

Inspection Procedure Validation

- Tecnatom, S.A.

Inspection Services

- American Crane & Equipment Corp.
HSB Global Standards
Powerfect
- Rolls-Royce
- Schulz Electric Company
- Tecnatom, S.A.

Inspection: Balance-of-Plant

- Fauske & Associates., LLC
- Rolls-Royce

Inspection: Equipment

- American Crane & Equipment Corp.
- Diakont
- Remote Ocean Systems (ROS)
- Rolls-Royce
- Schulz Electric Company

Inspection: Feedwater Nozzle

- Rolls-Royce

Inspection: In-Service

- Diakont
- HSB Global Standards
International Quality Consultants, Inc.
- Rolls-Royce
- Sargent & Lundy
URS Corporation

Inspection: In-Vessel

- Diakont
- R.O.V. Technologies, Inc.
- Rolls-Royce

Inspection: Pipeline

- Rolls-Royce
- Structural Integrity Associates, Inc.

Inspection: Pressure Vessel

- Diakont
- HSB Global Standards
- Rolls-Royce

Inspection: Primary-Side Components

- Rolls-Royce

Inspection: Quality Control

- Bureau Veritas
- Hukari Ascendent
International Quality Consultants, Inc.

Inspection: Reactor Internals

- Rolls-Royce

Supporting the US and International Nuclear Industry for more than 40 years.

Custom Safety Chillers



UL555 Fire Dampers



Blast Doors



ASME Code Vessels



Ellis & Watts Global Industries, LLC

4400 Glen Willow Lake Lane

Batavia, Ohio 45203 USA

Tel: +1-513-752-9000 Fax: +1-513-752-4545

www.elliswatts.com

Inspection: Remote

- Diakont
- Rolls-Royce

Inspection: Secondary Side Components

- Rolls-Royce

Inspection: Steam Generator

- Candu Energy Inc
- Kinectrics Incorporated
- Rolls-Royce

Inspection: Vessel Welds, BWR

- Diakont
- Rolls-Royce

Inspections: Underwater

- Diakont
- Remote Ocean Systems (ROS)
- Rolls-Royce
- Underwater Construction Corporation

Installation: Equipment

- American Crane & Equipment Corp.
- Rolls-Royce

Installation: Fuel Rack

- Rolls-Royce
- Underwater Construction Corporation

Installation: Mechanical

- American Crane & Equipment Corp.
- BHI Energy
- Rolls-Royce

Installation: Piping

- Rolls-Royce

Installation: Setup

- BHI Energy
- Rolls-Royce

Instrument Power Supplies

- AZZ / NLI
- Nutherm International, Inc.
- Scientech, a business unit of Curtiss-Wright Flow Control Company
- Wyle Laboratories, Inc.

Instrument Racks: Seismic Multibay

- Rolls-Royce
- Thermo Scientific, NFMS Part of Thermo Fisher Scientific

Instrument Signal Isolation Devices

- Scientech, a business unit of Curtiss-Wright Flow Control Company
- Thermo Scientific, NFMS Part of Thermo Fisher Scientific

Instrument Stands

James C. White Company

Instrument Weatherhouses

- HI-Q Environmental Products Company

Instrumentation

- Analysis and Measurement Services Corp.
- AZZ / NLI
- Black & Veatch
- Enertech, a business unit of Curtiss-Wright Flow Control Company
- Mirion Technologies
- Scientech, a business unit of Curtiss-Wright Flow Control Company

Instrumentation Supports

James C. White Company

Instrumentation Tray

James C. White Company

Instrumentation/Control System Calibration

- Tecnomat, S.A.

Instrumentation/Control System Maintenance

- Analysis and Measurement Services Corp.
- Tecnomat, S.A.

Instrumentation/Control Systems

- Air Monitor Corp.
- Black & Veatch
- Diakont

- Rolls-Royce
- Scientech, a business unit of Curtiss-Wright Flow Control Company
- Zachry Nuclear Engineering, Inc

Instrumentation/Control Systems: Class 1E

- AZZ / NLI
- Black & Veatch
- Diakont
- DRS Consolidated Controls, Inc
- Enertech, a business unit of Curtiss-Wright Flow Control Company
- Fluid Components International (FCI)
- HF Controls
- Nutherm International, Inc.
- Scientech, a business unit of Curtiss-Wright Flow Control Company
- Thermo Scientific, NFMS Part of Thermo Fisher Scientific
- Valcor Engineering Corporation

Instrumentation/Control Systems: Repair

- Scientech, a business unit of Curtiss-Wright Flow Control Company

Instrumentation/Control: Part Replacement

- AZZ / NLI
- Scientech, a business unit of Curtiss-Wright Flow Control Company

Instrumentation: Health Physics

- HI-Q Environmental Products Company
- Mirion Technologies

Instrumentation: Monitoring Environmental

Staplex-Air Sampler Division

Instrumentation: Nuclear

- Black & Veatch
- Dynasil Products
- Fluid Components International (FCI)
- GE Hitachi Nuclear Energy
- HI-Q Environmental Products Company
- Mirion Technologies
- Rolls-Royce
- Scientech, a business unit of Curtiss-Wright Flow Control Company
- Thermo Scientific, NFMS Part of Thermo Fisher Scientific
- Valcor Engineering Corporation

Instrumentation: Packless

Valcor Engineering Corporation

Instrumentation: Process Control

- Mirion Technologies
- Scientech, a business unit of Curtiss-Wright Flow Control Company

Instrumentation: Radiation Protection

- Health Physics Instruments, Div. of Far West Technology
- Mirion Technologies

Instrumentation: Seismic

- AZZ / NLI

Instrumentation: Tritium

- HI-Q Environmental Products Company

Instruments

- Mirion Technologies
- Scientech, a business unit of Curtiss-Wright Flow Control Company

Instruments: Aerosol Leak Detection

- NUCON International, Inc.

Instruments: Air Velocity

- HI-Q Environmental Products Company

Instruments: Contamination Monitoring

- HI-Q Environmental Products Company
- Mirion Technologies

Instruments: Electronic

- Scientech, a business unit of Curtiss-Wright Flow Control Company

Instruments: Halide Leak Detection

- NUCON International, Inc.

Instruments: Liquid Level & Density

- AZZ / NLI
- Enertech, a business unit of Curtiss-Wright Flow Control Company
- Rolls-Royce

Instruments: Meteorological

Murray and Trettel, Inc.

Instruments: Portable Survey

- Biodex Medical Systems, Inc.
- Mirion Technologies
- S-E International, Inc

Instruments: Safety-Related

- AZZ / NLI
- Black & Veatch
- Enertech, a business unit of Curtiss-Wright Flow Control Company
- Mirion Technologies
- Nutherm International, Inc.
- Scientech, a business unit of Curtiss-Wright Flow Control Company
- Wyle Laboratories, Inc.

Instruments: Temperature Measuring

- AZZ / NLI
- Enertech, a business unit of Curtiss-Wright Flow Control Company
- Scientech, a business unit of Curtiss-Wright Flow Control Company

Insulation: Thermal

- Performance Contracting Inc. (PCI)
- Transco Products Inc.

Integration: System

- Oregon Iron Works, Inc

Inventory Management

- ATC-Nuclear
- Scientech, a business unit of Curtiss-Wright Flow Control Company
- The Shaw Group
- Trust Manufacturing

Inventory Tracking Systems

- Scientech, a business unit of Curtiss-Wright Flow Control Company

Inverters

- AMETEK Programmable Power, Supporting Elgar Nuclear Equip.
- AZZ / NLI
- GUTOR Electronic LLC
- Nutherm International, Inc.
- Wyle Laboratories, Inc.

Inverters: Static, Maintenance

Ultimate Power Solutions

Investigations: Accident

- Conger & Elsea, Inc.
- Fauske & Associates., LLC

Investigations: Event

- Conger & Elsea, Inc.
- Fauske & Associates., LLC

Investigations: Incident

- Conger & Elsea, Inc.
- Fauske & Associates., LLC

Investigations: Pre-Employment Screening

- BHI Energy
- CartwrightDownes, Inc.

Ion Exchange Equipment

- Diversified Technologies Services, Inc.
- Enertech, a business unit of Curtiss-Wright Flow Control Company
- Rolls-Royce

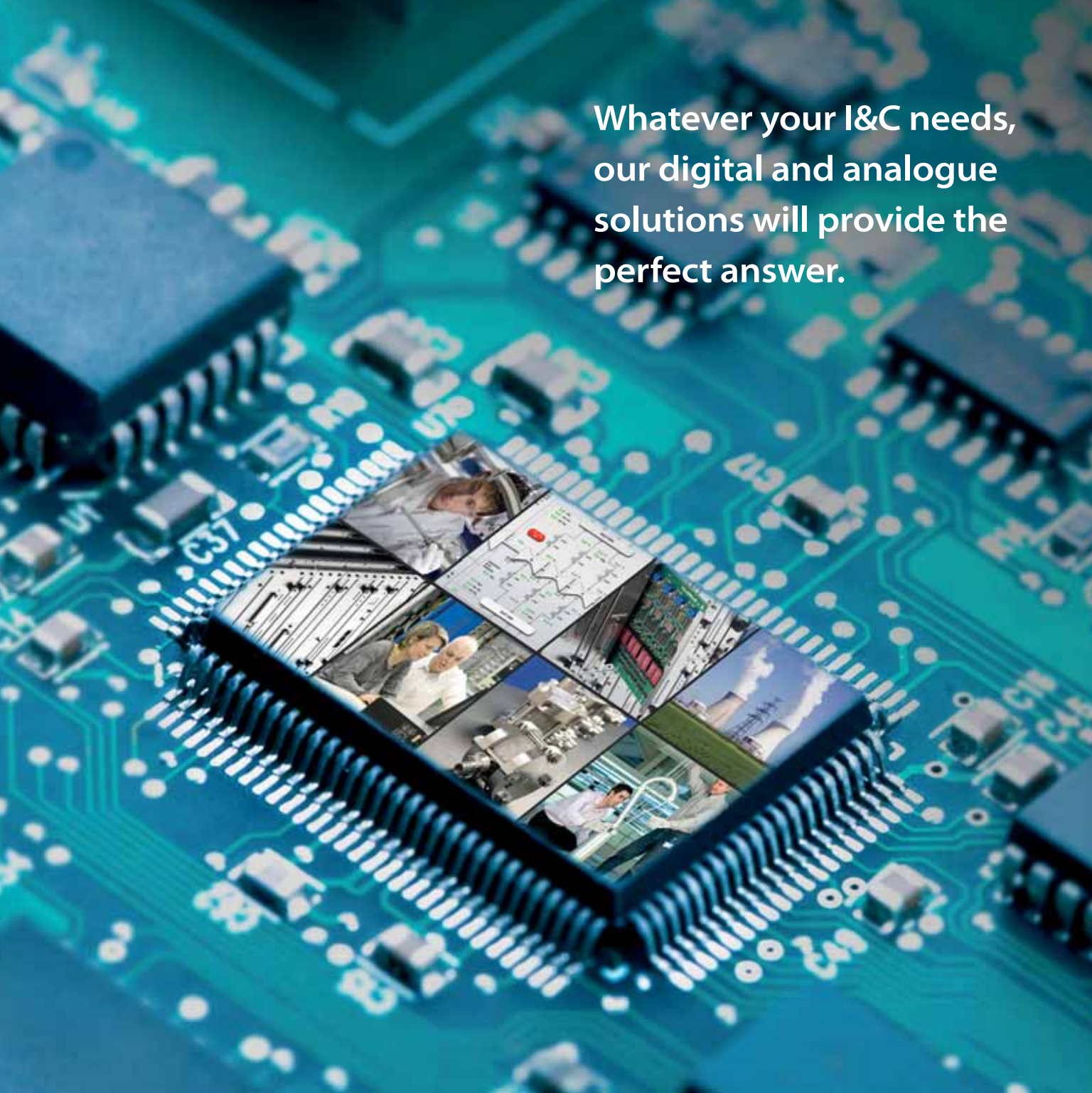

Whatever your I&C needs,
our digital and analogue
solutions will provide the
perfect answer.

When you're looking to maximise availability, minimise operating costs and ensure the highest levels of safety and reliability, you need a partner you can trust to provide the licensing, operation and long term support of your I&C solutions. You'll demand certified and qualified solutions from fully integrated plant process systems to safety-critical instrumentation, core control systems and

high integrity monitoring equipment. 200 nuclear reactors worldwide are currently benefiting from this proven expertise. More than 700 Rolls-Royce I&C systems are already at the heart of reactors across Europe, North America and Asia. With our 40 year track record in I&C, we can help you succeed.

Trusted to deliver excellence

Ion Exchange Media

Diversified Technologies Services, Inc.
 Enertech, a business unit of Curtiss-Wright
 Flow Control Company

Ion Exchange Media: Organic

Enertech, a business unit of Curtiss-Wright
 Flow Control Company

Ion Exchange Resins

Enertech, a business unit of Curtiss-Wright
 Flow Control Company
 • Kinectrics Incorporated

Ion Exchange Systems

Enertech, a business unit of Curtiss-Wright
 Flow Control Company
 • Rolls-Royce

Isolators: Analog Signal

Nutherm International, Inc.
 • Sciencetech, a business unit of Curtiss-Wright
 Flow Control Company
 • Technology for Energy Corporation (TEC)

Isolators: Digital Signal

Biodex Medical Systems, Inc.
 • Sciencetech, a business unit of Curtiss-Wright
 Flow Control Company
 • Technology for Energy Corporation (TEC)

Joints: Expansion

Croll-Reynolds Engineering Company Inc.

Lab Analysis: Environmental

• Kinectrics Incorporated

Lab Analysis: Radiological

Eberline Services Inc.
 • Herguth Laboratories
 • Kinectrics Incorporated
 Teledyne Brown Engineering, Inc.

Lab Research: Materials

• Kinectrics Incorporated

Labels

Euclid Garment Manufacturing Company
 • Frham Safety Products, Inc.
 Uticom Systems Inc.

Labels: Bar Coded

Uticom Systems Inc.

Labels: Warning

Biodex Medical Systems, Inc.
 Uticom Systems Inc.

Labor Management

BHI Energy

Laboratory Services

• Fauske & Associates., LLC
 • Herguth Laboratories

Laundry Services

• UniTech Services Group, Inc., Div. of Unifirst
 Corp.

Laundry: Water Wash

• UniTech Services Group, Inc., Div. of Unifirst
 Corp.

Laundry: Water Wash: Mobile

• UniTech Services Group, Inc., Div. of Unifirst
 Corp.

Lead Paint Abatement Equipment

Pentek, Inc.

Lead Shielding Refurbishment

LANCS Industries Holdings, LLC.
 • Rolls-Royce

Lead Shielding: New

Biodex Medical Systems, Inc.
 Dufrane Nuclear Shielding, Inc.
 • Frham Safety Products, Inc.
 MarShield, Div. of Mars Metal Company
 • Rolls-Royce

Lead: All Forms

MarShield, Div. of Mars Metal Company
 • TW Metals - Nuclear Materials Solutions

Lead: Hot Pours

MarShield, Div. of Mars Metal Company

Leak Detection Equipment

Conco Systems, Inc.
 Enertech, a business unit of Curtiss-Wright
 Flow Control Company
 • NUCON International, Inc.

Leak Detection Services

Conco Systems, Inc.
 Powerfect

Licensing Support Services

• Bechtel Power
 CTR Technical Services, Inc.
 NPTS, Inc.
 RCM Technologies, Inc.
 Sargent & Lundy
 • Sciencetech, a business unit of Curtiss-Wright
 Flow Control Company
 URS Corporation
 WMG, Inc.
 • Zachry Nuclear Engineering, Inc

Licensing: Technical Specifications

CTR Technical Services, Inc.

Life Extension

Black & Veatch
 • Candu Energy Inc
 Enertech, a business unit of Curtiss-Wright
 Flow Control Company
 • Fauske & Associates., LLC
 Sargent & Lundy
 • Sciencetech, a business unit of Curtiss-Wright
 Flow Control Company
 Wyle Laboratories, Inc.

Life Extension: Plant

• Bechtel Power
 • Fauske & Associates., LLC
 • Sciencetech, a business unit of Curtiss-Wright
 Flow Control Company

Life Extension: Plant, BWR

• Bechtel Power
 Black & Veatch
 • Fauske & Associates., LLC
 • Sciencetech, a business unit of Curtiss-Wright
 Flow Control Company

Lifting: Heavy

• American Crane & Equipment Corp.
 Black & Veatch
 Del Mar Avionics

Lighting

• BIRNS, Inc.
 Black & Veatch
 • Diakont

Lights: Underwater

• BIRNS, Inc.
 • Diakont
 Lights, Camera, Action LLC
 Remote Ocean Systems (ROS)

Liners

Diversified Technologies Services, Inc.
 • EST Group, a business unit of Curtiss-Wright
 Flow Control Company
 • Frham Safety Products, Inc.
 Fuel Tank Maintenance Company LLC
 Reef Industries, Inc.
 • Rolls-Royce

Logic System: Class 1E

• AZZ / NLI

H Herguth Laboratories, Inc.
People and Data You Can Count On!

- Integrity
- Dedication
- Customer Service

Technical Ability

Systems

Why would you need to use any other lab?

Contact Herguth Laboratories, Inc. today to find out what sets us apart.

H Herguth Laboratories, Inc.
People and Data You Can Count On!

1-800-OIL-LABS • www.herguth.com

Loose Part Monitoring Systems

- Technology for Energy Corporation (TEC)

Loose Part Retrieval

- Rolls-Royce

Louvers

- Ellis & Watts Global Industries, LLC.
- SSM Industries, Inc.

Low-Level Waste Systems: Refurbishment

- Rolls-Royce

Lubrication Analysis

- Herguth Laboratories
R&G Laboratories, Inc

Machines: Grinding

- Rolls-Royce

Machines: Milling

- Energy Steel & Supply CO.
- Rolls-Royce

Machining

- American Crane & Equipment Corp.
- Energy Steel & Supply CO.
Hydratight
Penn Iron Works, Inc.
Precision Custom Components, LLC
- Rolls-Royce
- Schulz Electric Company
- Trust Manufacturing
- Westerman Nuclear

Machining: BWR Remote

- Advanced Consulting Group, Inc.

Machining: Compressors

- Precision Custom Components, LLC

Machining: Coupling

- Energy Steel & Supply CO.

Machining: Flanges

- Energy Steel & Supply CO.

- Oregon Iron Works, Inc
- Trust Manufacturing

Machining: Generators

- Precision Custom Components, LLC

Machining: Heat Exchanger

- Energy Steel & Supply CO.
- Joseph Oat Corporation
- Oregon Iron Works, Inc
Precision Custom Components, LLC
- Rolls-Royce
- Westerman Nuclear

Machining: Journals

- Schulz Electric Company

Machining: Motors

- Schulz Electric Company

Machining: Nozzle

- Oregon Iron Works, Inc

Machining: Pumps

- Precision Custom Components, LLC

Machining: Rotor

- Precision Custom Components, LLC
- Schulz Electric Company

Machining: Rotor Bore

- Schulz Electric Company

Machining: Safety-Related

- Energy Steel & Supply CO.
Fusion Babbiting Co. Inc
- Joseph Oat Corporation
Nutherm International, Inc.
- Oregon Iron Works, Inc
Penn Iron Works, Inc.
Precision Custom Components, LLC
- Schulz Electric Company

Machining: Seals

- Seal Master Corporation
- Trust Manufacturing

Machining: Thread Milling

- Energy Steel & Supply CO.
Precision Custom Components, LLC
- Trust Manufacturing

Machining: Turbine

- Precision Custom Components, LLC
- Rolls-Royce

Machining: Valve

- Enertech, a business unit of Curtiss-Wright
Flow Control Company
Precision Custom Components, LLC

Maintenance

- American Crane & Equipment Corp.
CHAMPS Software, Inc.
CORE, Inc.
- Rolls-Royce
- Schulz Electric Company
- The Shaw Group

Maintenance Management Systems

- CHAMPS Software, Inc.
CORE, Inc.
- Rolls-Royce
Sargent & Lundy

Maintenance Program Evaluation

- CORE, Inc.
- Hukari Ascendent
- Rolls-Royce
Sargent & Lundy

Maintenance Services

- American Crane & Equipment Corp.
Aquilex WSI Nuclear Services
BHI Energy
CORE, Inc.

Unparalleled Brilliance, Unmatched Performance

The BIRNS Corona™ is an advanced, high performance, high intensity nuclear-grade light—a brilliant, high pressure 1kW sodium vapor system with 132,000 lumens and a 24,000 hour lamp life. Its unique mirror-finish parabolic reflector maximizes light output, and the system can be operated wet or dry, and relamped tool-free by hand in 60 seconds.

The BIRNS Corona is seismically qualified per IEEE-344, and even exceeded its requirements in a recent test. It successfully passed at ~8 gs of spectral acceleration at key frequencies—proving it capable of surviving the strongest of earthquakes.

That's why it's trusted in nuclear power stations worldwide for brilliant illumination of fuel pools, reactor cavities and for turbine inspection—or any application requiring long term use, low maintenance and massive light output.

Scan QR Code for amazing video of BIRNS Corona during IEEE-34 seismic testing.

www.blrns.com

NRC 10CFR50, App. B Compliant
ISO 9001:2008 Certified by DNV

1720 Fiske Place, Oxnard, CA 93033-1863, U.S.A.
T +1.805.487.5393 • F 805.487.0427 • Toll-Free 1.888.81RNS.88

- Day & Zimmermann ECM
Enertech, a business unit of Curtiss-Wright
Flow Control Company
Sargent & Lundy
- Schulz Electric Company

Maintenance Services: Offsite

- American Crane & Equipment Corp.
- Schulz Electric Company

Maintenance Services: Underwater

Underwater Construction Corporation

Maintenance Support

- American Crane & Equipment Corp.
BHI Energy
CORE, Inc.
- G.D. Barri & Associates, Inc.
- Mirion Technologies
- Schulz Electric Company

Maintenance: Condenser

Conco Systems, Inc.
Powerfect

Maintenance: Equipment

- American Crane & Equipment Corp.
CHAMPS Software, Inc.
- Schulz Electric Company

Maintenance: HEPA Systems

- Rolls-Royce
- UniTech Services Group, Inc., Div. of Unifirst Corp.

Maintenance: Predictive

- CORE, Inc.
- Herguth Laboratories
Ludeca Inc.
- Mirion Technologies
- Rolls-Royce
Sargent & Lundy
- Schulz Electric Company

Maintenance: Preventive

- American Crane & Equipment Corp.
BHI Energy
CHAMPS Software, Inc.
CORE, Inc.
- Herguth Laboratories
Ludeca Inc.
- Mirion Technologies
- Rolls-Royce
Sargent & Lundy
- Schulz Electric Company

Maintenance: Reliability Centered

- CHAMPS Software, Inc.
CORE, Inc.
- Rolls-Royce
S.M. Stoller Corp.
Sargent & Lundy
- Schulz Electric Company
- Scientech, a business unit of Curtiss-Wright
Flow Control Company

Maintenance: Valves

BHI Energy
Enertech, a business unit of Curtiss-Wright
Flow Control Company
Flowserve Flow Control Division

Management: Construction

Black & Veatch
Sargent & Lundy

Manifolds

- AZZ / NLI
James C. White Company
Valcor Engineering Corporation

Manifolds: Packless Globe and Instrumentation

Valcor Engineering Corporation

Manipulator Vehicles

- Siempelkamp Nukleartechnik GmbH

Manipulators: Robotic

- American Crane & Equipment Corp.
- Diakont
R.O.V. Technologies, Inc.

- Rolls-Royce
- Siempelkamp Nukleartechnik GmbH
Walischmiller Engineering GmbH

Manufacturing Services

- American Crane & Equipment Corp.
- Diakont
Novatech
- Oregon Iron Works, Inc
- Rolls-Royce
- Schulz Electric Company

Manway Closure Services

- Rolls-Royce
- Scientech, a business unit of Curtiss-Wright
Flow Control Company

Manway Cover Handling System

- Rolls-Royce
- Scientech, a business unit of Curtiss-Wright
Flow Control Company

Manway Repair Services

- Energy Steel & Supply CO.
- Rolls-Royce

Markers: Fiber Optic

TECH Products, Inc.
Uticom Systems Inc.

Markers: Industrial

Uticom Systems Inc.

Marketing Services

Streicker & Company Inc.

Material Control and Accountability

Argonne National Laboratory, Vulnerability
Assessment Team

Material: ASME Code

- AT&F Nuclear, Inc, Division of AT & F
Black & Veatch
- Energy Steel & Supply CO.
- Joseph Oat Corporation
- Oregon Iron Works, Inc
Precision Custom Components, LLC
- Rolls-Royce
Tioga Pipe Supply Company Inc.
- Trust Manufacturing
- TW Metals - Nuclear Materials Solutions

Material: Inconel 600 Series

- Energy Steel & Supply CO.
- Rolls-Royce

Materials Characterization

Engineering Mechanics Corporation of Co-
lumbus
• Westerman Nuclear

Materials Handling Equipment

- American Crane & Equipment Corp.
- Diakont
Konecranes Nuclear Equipment & Services
LLC
PaR Systems, Inc.
- Rolls-Royce
- Siempelkamp Nukleartechnik GmbH

Materials Handling Equipment: Rollers

- Rolls-Royce

Materials Management

Black & Veatch
CHAMPS Software, Inc.
• Rolls-Royce
- The Shaw Group

Materials Management Systems

CHAMPS Software, Inc.
• Rolls-Royce

Materials Services: BWR

- Energy Steel & Supply CO.

Materials Testing Equipment

- Energy Steel & Supply CO.
- Rolls-Royce
- Technology for Energy Corporation (TEC)

Materials: Qualified

- Energy Steel & Supply CO.
- Oregon Iron Works, Inc

- Performance Contracting Inc. (PCI)
- Rolls-Royce
- Schulz Electric Company
- Trust Manufacturing
- TW Metals - Nuclear Materials Solutions
- Westerman Nuclear
Wyle Laboratories, Inc.

Mats

McNichols Company

Measurement Services

- Analysis and Measurement Services Corp.
- Technology for Energy Corporation (TEC)

Measurement Systems

- Analysis and Measurement Services Corp.
- Mirion Technologies
- Rolls-Royce

Measurement Systems: Photogrammetric

- Rolls-Royce

Metal Fabrication

- American Crane & Equipment Corp.
- AT&F Nuclear, Inc, Division of AT & F
AZCO INC.
Container Products Corporation
Dufrane Nuclear Shielding, Inc.
James C. White Company
- Joseph Oat Corporation
- Oregon Iron Works, Inc
Penn Iron Works, Inc.
- Performance Contracting Inc. (PCI)
Precision Custom Components, LLC
- Scientech, a business unit of Curtiss-Wright
Flow Control Company
- SSM Industries, Inc.
- Trust Manufacturing
- Westerman Nuclear

Metal Fabrication: Aluminum

- Container Products Corporation
- Oregon Iron Works, Inc
- Rolls-Royce
- SSM Industries, Inc.
- Trust Manufacturing

Metal Fabrication: Lead

- Oregon Iron Works, Inc
- Rolls-Royce

Metal Fabrication: Nickel & Nickel Alloy

- Joseph Oat Corporation
- Oregon Iron Works, Inc
Penn Iron Works, Inc.
Precision Custom Components, LLC
- Rolls-Royce
- SSM Industries, Inc.
- Trust Manufacturing
- Westerman Nuclear

Metal Fabrication: Stainless Steel

- American Crane & Equipment Corp.
- AT&F Nuclear, Inc, Division of AT & F
Container Products Corporation
- Energy Steel & Supply CO.
James C. White Company
- Joseph Oat Corporation
- Oregon Iron Works, Inc
Penn Iron Works, Inc.
Precision Custom Components, LLC
- Rolls-Royce
- SSM Industries, Inc.
- Trust Manufacturing
- Westerman Nuclear

Metal Fabrication: Steel

- American Crane & Equipment Corp.
Container Products Corporation
- Energy Steel & Supply CO.
James C. White Company
- Joseph Oat Corporation
- Oregon Iron Works, Inc
Penn Iron Works, Inc.
Precision Custom Components, LLC
- Rolls-Royce
- SSM Industries, Inc.

VALUE YOU CAN HANG YOUR HAT ON



SAFETY, INTEGRITY, DIVERSITY, SUCCESS

In the 21st century, the power sector finds itself facing unprecedented operational pressures, shifting priorities, and increasing regulatory scrutiny. With our comprehensive industry experience and seasoned professional staff, Day & Zimmermann is uniquely positioned to partner with our customers to deliver the value-added solutions they require in order to thrive in this environment.

Our field-focused operations teams have delivered industry best-practices and continuous improvement innovations in every phase of project delivery. Safety is our number-one core value, and it permeates everything we do in optimizing the performance of our customers' plant assets. You can depend on us to be your trusted value partner.

dayzim.com

Day & Zimmermann
We do what we say.®

- Trust Manufacturing
- Westerman Nuclear

Metal Fabrication: Titanium

- AT&F Nuclear, Inc, Division of AT & F
- Joseph Oat Corporation
- Oregon Iron Works, Inc
- Precision Custom Components, LLC
- Rolls-Royce
- Trust Manufacturing

Metal Facing

Precision Custom Components, LLC

Metal: Alloy

- Chatham Steel Corporation
- Energy Steel & Supply CO.
- Rolls-Royce
- TW Metals - Nuclear Materials Solutions

Metal: Alloy Bar

- Chatham Steel Corporation
- Energy Steel & Supply CO.
- Rolls-Royce
- Tioga Pipe Supply Company Inc.
- Trust Manufacturing
- TW Metals - Nuclear Materials Solutions

Metal: Alloy Plate

- Chatham Steel Corporation
- Energy Steel & Supply CO.
- Rolls-Royce
- Tioga Pipe Supply Company Inc.
- Trust Manufacturing
- TW Metals - Nuclear Materials Solutions

Metal: Expanded

- Chatham Steel Corporation
- McNichols Company
- Rolls-Royce
- Trust Manufacturing
- TW Metals - Nuclear Materials Solutions

Metal: High-Temperature

- Chatham Steel Corporation
- Rolls-Royce
- Trust Manufacturing
- TW Metals - Nuclear Materials Solutions

Metal: Lead Alloy

- Rolls-Royce
- TW Metals - Nuclear Materials Solutions

Metal: Perforated

- Chatham Steel Corporation
- Energy Steel & Supply CO.
- McNichols Company
- Rolls-Royce
- Trust Manufacturing
- TW Metals - Nuclear Materials Solutions

Metal: Pure Lead

- TW Metals - Nuclear Materials Solutions

Metallizing

- Oregon Iron Works, Inc
- Schulz Electric Company

Meters: Air Mass Flow

- Enertech, a business unit of Curtiss-Wright Flow Control Company
- Fluid Components International (FCI)
- HI-Q Environmental Products Company

Meters: Air Velocity

- HI-Q Environmental Products Company

Meters: Digital Survey

Biodex Medical Systems, Inc.

Meters: Electrical

- AZZ / NLI

Meters: Gas Flow

- Enertech, a business unit of Curtiss-Wright Flow Control Company
- Fluid Components International (FCI)
- Westerman Nuclear

Meters: Radiation Survey

- Biodex Medical Systems, Inc.
- Health Physics Instruments, Div. of Far West Technology
- Mirion Technologies
- S-E International, Inc

Meters: Radon

- Mirion Technologies

Meters: Safety-Related

- AZZ / NLI
- Enertech, a business unit of Curtiss-Wright Flow Control Company
- Nutherm International, Inc.

Meters: Stock Multipoint Mass Flow

- Enertech, a business unit of Curtiss-Wright Flow Control Company

Meters: Survey

- Mirion Technologies

Meters: Survey, Geiger-Mueller

- Biodex Medical Systems, Inc.
- Mirion Technologies

Meters: Survey, Neutron

- Health Physics Instruments, Div. of Far West Technology
- Mirion Technologies

Microscopy: Scanning Electron

Southwest Research Institute

Mixers: Fluid

- Rolls-Royce

Mock-Ups

- Rolls-Royce

Modeling: Plant Systems

- Black & Veatch
- Sargent & Lundy
- Zachry Nuclear Engineering, Inc

Modeling: Plume

- Black & Veatch
- Fauske & Associates., LLC

Modeling: Process

Black & Veatch

Models: Equipment

- Black & Veatch
- Rolls-Royce

Models: Heat Exchanger

- Black & Veatch
- Ellis & Watts Global Industries, LLC.
- Rolls-Royce
- Zachry Nuclear Engineering, Inc

Models: HVAC Systems

- Black & Veatch
- Ellis & Watts Global Industries, LLC.
- Zachry Nuclear Engineering, Inc

Models: Planning Layout

Black & Veatch

Models: Power Plant

- Black & Veatch
- Power & Energy Systems Services
- Zachry Nuclear Engineering, Inc

Models: Power Plant, Database

- Black & Veatch
- Zachry Nuclear Engineering, Inc

Models: Site

Black & Veatch

Models: Thermal Hydraulic System

- Black & Veatch
- Fauske & Associates., LLC
- Red Wolf Associates
- Zachry Nuclear Engineering, Inc

Modifications

- Black & Veatch
- NPTS, Inc.
- RCM Technologies, Inc.
- Sargent & Lundy
- URS Corporation

TW METALS

Delivering the Very Best in Nuclear Compliant Materials, Worldwide

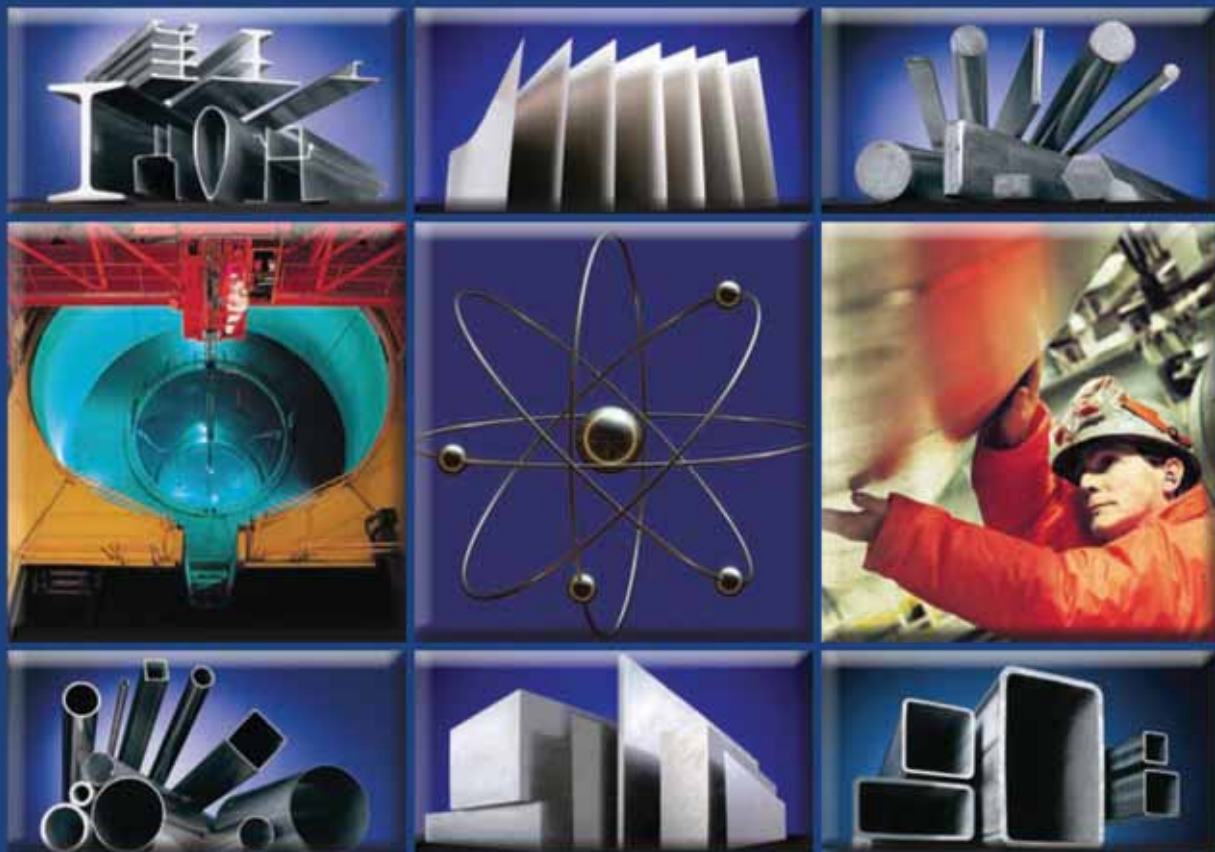

The world's leading nuclear energy providers and contractors count on TW Metals for:

COMPREHENSIVE PRODUCT LINE

A complete line of products in bar, tubing, pipe, plate, sheet, structural, fittings, fasteners, and consumables

FAST DELIVERY

TW Metals is your assurance of on-time delivery anywhere in the world

EXPERIENCE

Sales and quality staff with over 90 years of combined experience in nuclear manufacturing

SPECIALIZATION

Dedicated "nuclear only" facility and staff in Leetsdale, Pennsylvania, USA

For a no-obligation quote on your next order, please call 800-924-2171, or visit www.twmetals.com.



CERTIFICATE NUMBER:
QSC-697, 10CFR50, 10CFR21 and NQA-1

Modular Construction

- GE Hitachi Nuclear Energy

Moisture Separator Modification

- Black & Veatch
- Thermal Engineering International (USA)

Moisture Separators

- Black & Veatch
- Rolls-Royce
- Thermal Engineering International (USA)

Monitoring Systems

- Black & Veatch
- Diakont
- Mirion Technologies
- Rolls-Royce

Monitoring Systems: Airborne Radioactivity

- Apantec LLC, North Penn Business Park
- HI-Q Environmental Products Company
- Mirion Technologies

Monitoring Systems: Environmental Radiation

- ENVINET GmbH
- HI-Q Environmental Products Company
- Mirion Technologies

Monitoring Systems: Gas

- Mirion Technologies

Monitoring Systems: Neutron

- Mirion Technologies
- Thermo Scientific, NFMS Part of Thermo Fisher Scientific

Monitoring Systems: Neutron Flux

- Mirion Technologies
- Thermo Scientific, NFMS Part of Thermo Fisher Scientific

Monitoring Systems: Plant Safety

- Diakont
- HF Controls
- Sciencetech, a business unit of Curtiss-Wright Flow Control Company

Monitoring Systems: Remote

- BHI Energy
- Diakont
- Mirion Technologies

Monitoring Systems: Vibration

- Analysis and Measurement Services Corp. Ludeca Inc.
- Structural Integrity Associates, Inc.

Monitoring Technologies: Condition

- Diakont
- Herguth Laboratories
- Sciencetech, a business unit of Curtiss-Wright Flow Control Company

Monitoring: Air

- F+J Specialty Products, Inc.
- GEL Engineering LLC
- HI-Q Environmental Products Company
- Mirion Technologies
- Staplex-Air Sampler Division

Monitoring: Contamination

- Gammasonics Institute for Medical Research
- UniTech Services Group, Inc., Div. of Unifirst Corp.

Monitoring: Environmental Radiological

- Apantec LLC, North Penn Business Park
- Eberline Services Inc.
- F+J Specialty Products, Inc.
- Gammasonics Institute for Medical Research
- HI-Q Environmental Products Company
- S.M. Stoller Corp.

Monitoring: Equipment, BWR

- Diakont
- GE Hitachi Nuclear Energy
- Mirion Technologies

Monitoring: Groundwater

- BHI Energy
- GEL Engineering LLC
- S.M. Stoller Corp.

Monitoring: Motor Load

- Schulz Electric Company

Monitoring: Neutron

- Mirion Technologies

Monitoring: Radiation

- Apantec LLC, North Penn Business Park
- ENVINET GmbH
- Gammasonics Institute for Medical Research
- HI-Q Environmental Products Company
- Mirion Technologies

Monitoring: Water

- Gammasonics Institute for Medical Research

Monitors

- Rolls-Royce

Monitors: Air

- ENMET Corporation
- F+J Specialty Products, Inc.
- HI-Q Environmental Products Company
- Mirion Technologies

Monitors: Alpha

- HI-Q Environmental Products Company
- Mirion Technologies

Monitors: Area

- HI-Q Environmental Products Company
- Mirion Technologies

Monitors: Area Radiation

- Apantec LLC, North Penn Business Park
- Biodex Medical Systems, Inc.
- HI-Q Environmental Products Company
- Mirion Technologies

Monitors: Beta

- Mirion Technologies

New NPJ Video Channel



Nuclear Plant Journal's new YouTube channel features short (less than 3 minutes) videos covering the latest nuclear industry news. Visit our channel at YouTube.com/user/nuclearplantjournal to see the videos.

For questions, please contact Anu Agnihotri, (630) 352-3686, anu@goinfo.com



Monitors: Contamination

- Mirion Technologies
- UniTech Services Group, Inc., Div. of Unifirst Corp.

Monitors: Dose Rate

- Mirion Technologies
- Thermo Scientific, NFMS Part of Thermo Fisher Scientific

Monitors: Environmental

- HI-Q Environmental Products Company

Monitors: Gamma

- Mirion Technologies
- Thermo Scientific, NFMS Part of Thermo Fisher Scientific

Monitors: Gas

- Mirion Technologies

Monitors: Gas, Hydrogen & Oxygen

ENMET Corporation

Monitors: Gas, Post-Accident

- Mirion Technologies

Monitors: In-Core

- Mirion Technologies

Monitors: Intermediate Range

- Mirion Technologies
- Thermo Scientific, NFMS Part of Thermo Fisher Scientific

Monitors: Iodine

- Apantec LLC, North Penn Business Park
- HI-Q Environmental Products Company
- Mirion Technologies

Monitors: Iodine Air

- HI-Q Environmental Products Company
- Mirion Technologies

Monitors: Laundry Radioactivity

- Mirion Technologies
- UniTech Services Group, Inc., Div. of Unifirst Corp.

Monitors: Liquid

- Apantec LLC, North Penn Business Park
- Mirion Technologies

Monitors: Local Power Range

- Mirion Technologies

Monitors: Noble Gas

- Apantec LLC, North Penn Business Park
- Mirion Technologies

Monitors: Particulate

- Apantec LLC, North Penn Business Park
- HI-Q Environmental Products Company
- Mirion Technologies

Monitors: Personnel Contamination

- Mirion Technologies

Monitors: Portal

- Apantec LLC, North Penn Business Park
- Biodex Medical Systems, Inc.
- Mirion Technologies

Monitors: Portal Beta

- Mirion Technologies

Monitors: Portal Gamma

- Mirion Technologies

Monitors: Process Radiation

- Mirion Technologies

Monitors: Radiation

- Biodex Medical Systems, Inc.
- HI-Q Environmental Products Company
- Mirion Technologies
- S-E International, Inc

Monitors: Radioactive Waste Storage

- Dynasil Products
- HI-Q Environmental Products Company

Monitors: Source Range

- Mirion Technologies
- Thermo Scientific, NFMS Part of Thermo Fisher Scientific

Monitors: Stack Radiation

- HI-Q Environmental Products Company
- Mirion Technologies

Monitors: Temperature

- Diakont
- Mirion Technologies

Monitors: Tritium

- HI-Q Environmental Products Company

Monitors: Waste

- UniTech Services Group, Inc., Div. of Unifirst Corp.

Motor Control Center Refurbishment

- AZZ / NLI

Motor Control Centers: Safety-Related

- AZZ / NLI
- Nutherm International, Inc.
- Wyle Laboratories, Inc.

Motor Control Centers: Safety-Related Parts

- AZZ / NLI
- Kinectrics Incorporated
- Nutherm International, Inc.
- Wyle Laboratories, Inc.

Motor Operators: Repair

- AZZ / NLI
- BHI Energy
- Schulz Electric Company

Motor Refurbishing

- AZZ / NLI
- Energy Steel & Supply CO.
- Schulz Electric Company

Motor Starters: Safety-Related

- AZZ / NLI
- Nutherm International, Inc.
- Wyle Laboratories, Inc.

Motors: Auxiliary

- AZZ / NLI
- Peerless Electric
- Schulz Electric Company

Motors: Contaminated, Repair

- AZZ / NLI
- Schulz Electric Company

Motors: Electric

- AZZ / NLI
- Energy Steel & Supply CO.
- Peerless Electric
- Schulz Electric Company
- WITTENSTEIN

Motors: Electric, Current Signature Analysis

- Schulz Electric Company

Motors: Electric, Repair

- AZZ / NLI
- Energy Steel & Supply CO.
- Peerless Electric
- Schulz Electric Company

Motors: Repair, Safety-Related

- Energy Steel & Supply CO.
- Schulz Electric Company

Motors: Safety-Related

- AZZ / NLI
- Ellis & Watts Global Industries, LLC.
- Energy Steel & Supply CO.
- GE Hitachi Nuclear Energy
- Peerless Electric
- Schulz Electric Company
- Wyle Laboratories, Inc.

Motors: Thermal Profiles

- Schulz Electric Company

MOV Motors: Safety-Related Testing

- Analysis and Measurement Services Corp.
- AZZ / NLI
- Schulz Electric Company

EQUIPMENT RELIABILITY

Electric Motor/EDG Solutions for the Nuclear Industry

- Contaminated Motor Repair
- In-House Decon Facility
- MOV Motor Repair & Testing
- EQ (Inc. MOV) Insulation Systems
- New Safety-Related & EQ Motors
- Class 1E Motor Repair
- EDG Repair
- On-Site Services
- Vertical Test Stand



Above: Schulz Technicians using high pressure steam cleaning to decontaminate a 9000 hp rotor. Left: Completed rewind of 150 hp random wound motor pre-vpi.

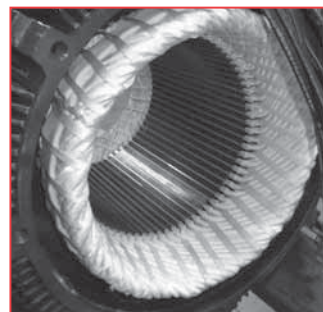

30 Gando Drive
New Haven, CT 06513
(800) 826-1425
www.schulzelectric.com

Nameplates

TECH Products, Inc.

NDE Services

- American Crane & Equipment Corp.
- AREVA Inc.
Fuel Tank Maintenance Company LLC
International Quality Consultants, Inc.
Laboratory Testing Inc.
- Rolls-Royce
- Structural Integrity Associates, Inc.
- URS Corporation
- Westerman Nuclear

NDE Services: Magnetic Particle

- Schulz Electric Company

NDE Services: Radiographic Testing

- Westerman Nuclear

NDE Services: Ultrasonic

- Structural Integrity Associates, Inc.

NDE: Section XI Support

- Structural Integrity Associates, Inc.

Neutron Absorption Materials

- Ceradyne Boron Products
- Dufrane Nuclear Shielding, Inc.
- Rolls-Royce

Neutron Flux Integrators

- Rolls-Royce

Neutron Spectrometry Equipment

Health Physics Instruments, Div. of Far West Technology

Nickel

- TW Metals - Nuclear Materials Solutions

Noise Control Systems

- Structural Integrity Associates, Inc.

Nondestructive Testing & Evaluation

- American Crane & Equipment Corp.
- Fauske & Associates., LLC

- Laboratory Services
Rogante Engineering Office
- Rolls-Royce
- Schulz Electric Company
- Tecnomat, S.A.
- Westerman Nuclear

Nondestructive Testing Equipment

- Diakont
- EST Group, a business unit of Curtiss-Wright
Flow Control Company
- Technology for Energy Corporation (TEC)
- Tecnomat, S.A.

Nondestructive Testing Inspections

- American Crane & Equipment Corp.
- EST Group, a business unit of Curtiss-Wright
Flow Control Company
- Rolls-Royce
- Schulz Electric Company
- Structural Integrity Associates, Inc.
- Tecnomat, S.A.

Nondestructive Testing Services

- American Crane & Equipment Corp.
Conco Systems, Inc.
Energy Resources Group, Inc.
- EST Group, a business unit of Curtiss-Wright
Flow Control Company
- Fauske & Associates., LLC
- Kinectrics Incorporated
National Inspection & Consultants, LLC.
- Structural Integrity Associates, Inc.
- Technology for Energy Corporation (TEC)
- Tecnomat, S.A.

Nondestructive Testing: Eddy Current

- Conco Systems, Inc.
- EST Group, a business unit of Curtiss-Wright
Flow Control Company
- Fauske & Associates., LLC
- Tecnomat, S.A.

Nozzle Dam Installation

- Scientech, a business unit of Curtiss-Wright
Flow Control Company

Nozzle Dams

- Scientech, a business unit of Curtiss-Wright
Flow Control Company
- Seal Master Corporation

Nozzle Maintenance

Aquilex WSI Nuclear Services

Nozzles

- Energy Steel & Supply CO.
- Oregon Iron Works, Inc
- Rolls-Royce

NPT Stamp Holder

- AT&F Nuclear, Inc, Division of AT & F
Bergen-Power Pipe Support, Inc
Black & Veatch
- Energy Steel & Supply CO.
Enertech, a business unit of Curtiss-Wright
Flow Control Company
- Joseph Oat Corporation
- Oregon Iron Works, Inc
Precision Custom Components, LLC
- Rolls-Royce

NQA-1 Qualified

Tioga Pipe Supply Company Inc.

NSSS: BWR

- Fauske & Associates., LLC
- Oregon Iron Works, Inc
- Rolls-Royce

NSSS: Equipment Modification, BWR

- Black & Veatch
- Fauske & Associates., LLC
- Rolls-Royce

Nuclear Cask: Lead Hot Pours

- Rolls-Royce
Seafab Metal Company

Nuclear Fuel Cycle: Engineering

- CTR Technical Services, Inc.
- GE Hitachi Nuclear Energy
- Rolls-Royce

Nuclear Instrumentation and Controls

- Apantec LLC, North Penn Business Park
- GE Hitachi Nuclear Energy

Nuclear Motors

Peerless Electric

Nuclear Utilities: Program Development

- HukariAscendent

Nuclear: Shielding

- Biodex Medical Systems, Inc.
- CTR Technical Services, Inc.
- Dufrane Nuclear Shielding, Inc.
- Oregon Iron Works, Inc
- Rolls-Royce
- Tranco Products Inc.
- TW Metals - Nuclear Materials Solutions

Nuts

- Energy Steel & Supply CO.
Niagara Fasteners Inc.
Superbolt Inc.
- Trust Manufacturing

Obsolescence

- Curtiss-Wright Flow Control Company

Obsolescence-Cannibalization

- Curtiss-Wright Flow Control Company

Obsolescence-Design Change

- Curtiss-Wright Flow Control Company

Obsolescence-Rebuild, Repair

- ATC-Nuclear
- Curtiss-Wright Flow Control Company

Obsolescence-Reverse Engineering

- ATC-Nuclear
- Curtiss-Wright Flow Control Company

Advanced materials for very high temperature applications, enhanced criticality control, and for safe and efficient fuel cycle management.

Highest Purity Stable Isotopes for Nuclear Power Plant Chemistries



Control the nuclear reaction rate
Enriched Boric Acid (E¹⁰BA)

Neutralize acidity
Enriched Lithium Hydroxide-Monohydrate (L)

Flood the reactor core for emergency shutdown
Enriched Sodium Pentaborate (NaP¹⁰B)



nuclear@ceradyne.com
www.ceradyne.com
918-673-2201

GE Hitachi Nuclear Energy



Kernkraftwerk Leibstadt AG (KKL) improves monitoring instrumentation with GE Hitachi Nuclear Energy technology.

GE Hitachi's Wide Range Neutron Monitoring system (WRNM) I&C Technology uses permanent in-core power detectors that eliminate drive mechanisms and associated under vessel servicing. The system's filtered digital data provides reliable transition through startup ranges, reducing the time required to power up after outages.

Visit ge.com/nuclear for more information.



HITACHI

Obsolescence-Special Mfg.Runs

- Curtiss-Wright Flow Control Company

Obsolescence-Substitution

- Curtiss-Wright Flow Control Company

Obsolescence-Surplus

- ATC-Nuclear
- Curtiss-Wright Flow Control Company

Off-Gas Systems

- AAF International

Oil Analysis

- Herguth Laboratories
- R&G Laboratories, Inc

Oil Analysis Equipment

- Herguth Laboratories

Operating Services

- Bechtel Power

Operation Procedure Upgrades

- HukariAscendent

Operations Support

- BHI Energy
- G.D. Barri & Associates, Inc.
- HukariAscendent
- The Shaw Group

Orifices; Flat-Faced

- Energy Steel & Supply CO.

Outage Equipment

- American Crane & Equipment Corp.
- Diakont
- Frham Safety Products, Inc.
- Mirion Technologies

Outage Management

- AREVA Inc.
- CHAMPS Software, Inc.
- GE Hitachi Nuclear Energy
- Sargent & Lundy

Outage Modification Implementation

- American Crane & Equipment Corp.

Outage Planning

- Sargent & Lundy

Outage Support Services

- American Crane & Equipment Corp.
- BHI Energy
- Day & Zimmermann ECM

Enertech, a business unit of Curtiss-Wright

- Flow Control Company
- GE Hitachi Nuclear Energy
- RCM Technologies, Inc.
- Rolls-Royce
- Sargent & Lundy
- Schulz Electric Company
- Sciencetech, a business unit of Curtiss-Wright
- Flow Control Company
- Structural Integrity Associates, Inc.
- Studsvik, Inc
- Transco Products Inc.
- URS Corporation

Outage Support: Radiation Protection

- Dufrane Nuclear Shielding, Inc.
- Frham Safety Products, Inc.
- Rolls-Royce
- UniTech Services Group, Inc., Div. of Unifirst Corp.

Painting

- American Crane & Equipment Corp.
- Energy Steel & Supply CO.
- Fuel Tank Maintenance Company LLC

Panels: Custom, Safety-Related

- AZZ / NLI
- Energy Steel & Supply CO.
- Nutherm International, Inc.
- Oregon Iron Works, Inc
- Rolls-Royce
- Sciencetech, a business unit of Curtiss-Wright
- Flow Control Company
- SSM Industries, Inc.
- Wyle Laboratories, Inc.

Panels: Instrument

- AZZ / NLI
- Energy Steel & Supply CO.
- Rolls-Royce
- Sciencetech, a business unit of Curtiss-Wright
- Flow Control Company

Panels: Power Distribution, Safety-Related

- AZZ / NLI
- Nutherm International, Inc.
- Sciencetech, a business unit of Curtiss-Wright
- Flow Control Company
- Wyle Laboratories, Inc.

Panels: Safety-Related

- AZZ / NLI
- Energy Steel & Supply CO.
- Nutherm International, Inc.
- Oregon Iron Works, Inc
- Sciencetech, a business unit of Curtiss-Wright
- Flow Control Company
- Wyle Laboratories, Inc.

Parts Evaluation

- AZZ / NLI
- Energy Steel & Supply CO.
- Kinectrics Incorporated
- Sciencetech, a business unit of Curtiss-Wright
- Flow Control Company

Parts: BWR Spare

- AZZ / NLI
- Energy Steel & Supply CO.
- GE Hitachi Nuclear Energy
- Oregon Iron Works, Inc
- Sciencetech, a business unit of Curtiss-Wright
- Flow Control Company

Parts: O.E.M.

- American Crane & Equipment Corp.
- AZZ / NLI
- Energy Steel & Supply CO.
- Enertech, a business unit of Curtiss-Wright
- Flow Control Company
- GE Hitachi Nuclear Energy
- Rolls-Royce
- Sciencetech, a business unit of Curtiss-Wright
- Flow Control Company
- Trust Manufacturing
- Wyle Laboratories, Inc.

Parts: Procurement Assistance

- American Crane & Equipment Corp.
- AZZ / NLI
- Bechtel Power
- Bureau Veritas
- Kinectrics Incorporated
- Rolls-Royce
- Sciencetech, a business unit of Curtiss-Wright
- Flow Control Company
- Trust Manufacturing

Parts: Replacement

- American Crane & Equipment Corp.
- Enertech, a business unit of Curtiss-Wright
- Flow Control Company
- Schulz Electric Company
- Sciencetech, a business unit of Curtiss-Wright
- Flow Control Company
- Siempelkamp Nukleartechnik GmbH
- Trust Manufacturing
- Wyle Laboratories, Inc.

Parts: Replacement, Design

- American Crane & Equipment Corp.
- AZZ / NLI
- Candu Energy Inc
- Siempelkamp Nukleartechnik GmbH
- Trust Manufacturing

Parts: Spare

- American Crane & Equipment Corp.
- AZZ / NLI
- Energy Steel & Supply CO.
- Enertech, a business unit of Curtiss-Wright
- Flow Control Company
- Joseph Oat Corporation
- Penn Iron Works, Inc.
- Rolls-Royce
- Sciencetech, a business unit of Curtiss-Wright
- Flow Control Company
- Trust Manufacturing
- Wyle Laboratories, Inc.

Parts: Used

- American Crane & Equipment Corp.
- Sciencetech, a business unit of Curtiss-Wright
- Flow Control Company

Penetrations: Containment

- Black & Veatch
- Energy Steel & Supply CO.
- Mirion Technologies
- Oregon Iron Works, Inc
- Rolls-Royce

Penetrations: Electrical

- Black & Veatch
- Mirion Technologies
- Rolls-Royce
- Teledyne Brown Engineering, Inc.

Penetrations: Electrical, Adaptor Modules

- Mirion Technologies
- Rolls-Royce

Personal Computers: Air Quality Sampling

- HI-Q Environmental Products Company

Personnel Services

- BHI Energy

PHWR Fuel

- GE Hitachi Nuclear Energy

PHWR Refueling Equipment

- GE Hitachi Nuclear Energy

Pigs: Pipeline

- Energy Steel & Supply CO.

Pipe

- Black & Veatch
- Energy Steel & Supply CO.
- Lincoln Structural Solutions (LSS Nuclear)
- The Shaw Group
- Tioga Pipe Supply Company Inc.
- Trust Manufacturing



THE WORLD'S LARGEST SURGE BARRIER, A NEW STANDARD IN FLOOD PROTECTION

At nearly two miles long and 26 feet high, Shaw's Surge Barrier project is the largest design-build civil works project in U.S. Army Corps of Engineers history and one of New Orleans' first lines of defense against storm surge. The innovative techniques that Shaw used for this surge barrier system are directly applicable to address potential flooding concerns at nuclear power plants around the world.

POST-FUKUSHIMA SOLUTIONS

THERMAL PERFORMANCE

SECURITY MODIFICATIONS

INDEPENDENT SPENT FUEL STORAGE INSTALLATION

FLOOD PROTECTION



POWER • ENVIRONMENTAL & INFRASTRUCTURE
FABRICATION & MANUFACTURING

www.shawgrp.com



Pipe Assemblies

- AT&F Nuclear, Inc, Division of AT & F AZCO INC.
- Energy Steel & Supply CO.
- Joseph Oat Corporation

Pipe Bending

- Energy Steel & Supply CO.

Pipe Bends

- Tioga Pipe Supply Company Inc.
- Trust Manufacturing

Pipe Beveling Machinery

- Chatham Steel Corporation
- Tri Tool Inc.

Pipe Beveling: Field Service

- Hydratight
- Tri Tool Inc.

Pipe Cleaning Service

- Fuel Tank Maintenance Company LLC

Pipe Crawlers

- Rolls-Royce

Pipe Cutting: Field Service

- Tri Tool Inc.

Pipe Fabrication

- AZCO INC.
- Energy Steel & Supply CO.
- Joseph Oat Corporation
- Oregon Iron Works, Inc
- The Shaw Group
- Tioga Pipe Supply Company Inc.
- Trust Manufacturing

Pipe Fabrication: Class 1

- Energy Steel & Supply CO.
- Joseph Oat Corporation
- Oregon Iron Works, Inc
- Trust Manufacturing

Pipe Fabrication: Class 2

- Energy Steel & Supply CO.
- Joseph Oat Corporation
- Oregon Iron Works, Inc
- Trust Manufacturing

Pipe Fabrication: Class 3

- Energy Steel & Supply CO.
- Joseph Oat Corporation
- Oregon Iron Works, Inc
- Trust Manufacturing

Pipe Fittings

- Energy Steel & Supply CO.
- Lincoln Structural Solutions (LSS Nuclear)
- The Shaw Group
- Tioga Pipe Supply Company Inc.
- Trust Manufacturing
- TW Metals - Nuclear Materials Solutions

Pipe Fittings: Cast Iron

- Trust Manufacturing

Pipe Fittings: Ductile Iron

- Trust Manufacturing

Pipe Fittings: Flanged-Weldneck-Slip On

- Energy Steel & Supply CO.
- Lincoln Structural Solutions (LSS Nuclear)
- Trust Manufacturing
- TW Metals - Nuclear Materials Solutions

Pipe Fittings: High-Alloy Steel

- Energy Steel & Supply CO.
- Trust Manufacturing
- TW Metals - Nuclear Materials Solutions

Pipe Fittings: Low-Alloy Steel

- Energy Steel & Supply CO.
- Trust Manufacturing
- TW Metals - Nuclear Materials Solutions

Pipe Fittings: Miscellaneous Metal

- Energy Steel & Supply CO.
- Trust Manufacturing
- TW Metals - Nuclear Materials Solutions

Pipe Fittings: Tee's

- Energy Steel & Supply CO.
- Tioga Pipe Supply Company Inc.
- Trust Manufacturing
- TW Metals - Nuclear Materials Solutions

Pipe Hanger Inspection

- Bechtel Power
- LISEGA SE

Pipe Hangers

- AZZ / NLI
- Bergen-Power Pipe Support, Inc
- Energy Steel & Supply CO.
- LISEGA SE
- Rolls-Royce

Pipe Restraints

- Bergen-Power Pipe Support, Inc
- Enertech, a business unit of Curtiss-Wright
- Flow Control Company
- Lisega Inc., (Sub. of Lisega AG)
- LISEGA SE

Pipe Snubbers

- Bergen-Power Pipe Support, Inc
- Energy Steel & Supply CO.
- Enertech, a business unit of Curtiss-Wright
- Flow Control Company
- Lisega Inc., (Sub. of Lisega AG)
- LISEGA SE

Pipe Supports

- Bergen-Power Pipe Support, Inc
- Energy Steel & Supply CO.
- Lisega Inc., (Sub. of Lisega AG)
- LISEGA SE
- Rolls-Royce
- The Shaw Group
- URS Corporation

Pipe: Alloy

- Chatham Steel Corporation
- Energy Steel & Supply CO.

COMPREHENSIVE SERVICE SOLUTIONS

for Nuclear Plant Construction, Maintenance and Decommissioning



888-TRITOOl • 916-288-6100 • www.tritool.com

Advanced Equipment Technology



Above: A critical weld in a nuclear power plant being performed by Tri Tool Thermal Services™ with Tri Tool's new DualARC™ dual-process TIG-MIG orbital weld head and OrbitMaster™ Digital Programmable Welding Arc Controller.

©2011

On-Site Contract Machining and Welding Services

As an OEM manufacturer, Tri Tool produces an extensive line of machining and automatic welding equipment. **This resource is our Toolbox.** Tri Tool is prepared to support your projects with nuclear qualified personnel and the equipment to get the job done right, on schedule and on budget.

- **Flow Accelerated Corrosion (FAC) Repairs**
- **(EPU) Extended Power Upgrades**
- **Technical Support**
- **Outage Planning and Special Engineering**
- **Equipment Rentals**

Specialized Machine Tool Design and Manufacturing

When your project calls for unique or custom machinery, Tri Tool Engineering can design and build manual or remote control equipment for your most demanding applications.

Contact Tri Tool for assistance with your next project.



TRI TOOL INC.
TRI TOOL THERMAL SERVICES™

- Tioga Pipe Supply Company Inc.
- Trust Manufacturing
- TW Metals - Nuclear Materials Solutions

Pipe: Aluminum

- Energy Steel & Supply CO.
- Trust Manufacturing
- TW Metals - Nuclear Materials Solutions

Pipe: Carbon-Steel

- Chatham Steel Corporation
- Energy Steel & Supply CO.
- Tioga Pipe Supply Company Inc.
- Trust Manufacturing
- TW Metals - Nuclear Materials Solutions

Pipe: Copper

- Trust Manufacturing
- TW Metals - Nuclear Materials Solutions

Pipe: Copper Alloy

- Tioga Pipe Supply Company Inc.
- Trust Manufacturing
- TW Metals - Nuclear Materials Solutions

Pipe: Corrosion-Resistant

- Tioga Pipe Supply Company Inc.
- Trust Manufacturing
- TW Metals - Nuclear Materials Solutions

Pipe: High-Alloy Steel

- Chatham Steel Corporation
- Trust Manufacturing
- TW Metals - Nuclear Materials Solutions

Pipe: Low-Alloy

- Chatham Steel Corporation
- TW Metals - Nuclear Materials Solutions

Pipe: Stainless Steel

- Chatham Steel Corporation
- Tioga Pipe Supply Company Inc.
- Trust Manufacturing
- TW Metals - Nuclear Materials Solutions

Pipe: Titanium

- TW Metals - Nuclear Materials Solutions

Pipe: Zirconium

- TW Metals - Nuclear Materials Solutions

Piping Analysis

- Design Engineering Analysis Corporation
- HukariAscendent
- Rolls-Royce
- Sargent & Lundy
- Zachry Nuclear Engineering, Inc

Piping Design

- HukariAscendent
- Rolls-Royce
- Sargent & Lundy
- URS Corporation
- Zachry Nuclear Engineering, Inc

Piping Inspection

- Diakont
- HukariAscendent
- Rolls-Royce
- Structural Integrity Associates, Inc.

Piping Layout

- Bechtel Power
- Rolls-Royce

Piping Maintenance

- EST Group, a business unit of Curtiss-Wright Flow Control Company
- Rolls-Royce

Piping Repair

- Black & Veatch
- Energy Steel & Supply CO.
- EST Group, a business unit of Curtiss-Wright Flow Control Company
- Rolls-Royce

Piping Replacement

- Aquilex WSI Nuclear Services
- Black & Veatch
- Energy Steel & Supply CO.
- Rolls-Royce

Planchets

- Biodex Medical Systems, Inc.
- Staplex-Air Sampler Division

Plant Life Management Services

- Candu Energy Inc

Plant Upgrading/Upgrading

- Day & Zimmermann ECM
- HukariAscendent
- Sargent & Lundy

Plate: Copper

- TW Metals - Nuclear Materials Solutions

Plugs

- Energy Steel & Supply CO.
- EST Group, a business unit of Curtiss-Wright Flow Control Company
- Joseph Oat Corporation
- Sciencetech, a business unit of Curtiss-Wright Flow Control Company
- Seal Master Corporation
- TW Metals - Nuclear Materials Solutions

Plugs: Condenser

- Conco Systems, Inc.
- Energy Steel & Supply CO.
- EST Group, a business unit of Curtiss-Wright Flow Control Company
- Heat Exchanger Products Corp.
- Joseph Oat Corporation

Plugs: Feedwater Heater

- Energy Steel & Supply CO.
- EST Group, a business unit of Curtiss-Wright Flow Control Company
- Joseph Oat Corporation
- Powerfect

Plugs: RPV Drain Pipe

- Energy Steel & Supply CO.

Plugs: Stud Hole

- EST Group, a business unit of Curtiss-Wright Flow Control Company
- Seal Master Corporation

Poison: Burnable

- Ceradyne Boron Products

Pollution Control Systems

- NUCON International, Inc.

Polyethylene: Fire-Retardant

- Reef Industries, Inc.

Polymer Solidification Services

- Diversified Technologies Services, Inc.

Power Conditioners

- AMETEK Programmable Power, Supporting Elgar Nuclear Equip.
- AZZ / NLI

Power Plants

- Black & Veatch

Power Supplies

- AMETEK Programmable Power, Supporting Elgar Nuclear Equip.
- Energy Steel & Supply CO.
- Fuel Tank Maintenance Company LLC

Power Supplies: High-Voltage

- AZZ / NLI
- Energy Steel & Supply CO.

Power Supplies: Safety-Related

- AZZ / NLI
- Nutherm International, Inc.
- Sciencetech, a business unit of Curtiss-Wright Flow Control Company
- Thermo Scientific, NFMS Part of Thermo Fisher Scientific
- Wyle Laboratories, Inc.

Preamplifiers: Instrumentation

- AZZ / NLI
- Mirion Technologies

Pressure Regulators

- Air Liquide America Specialty Gases, LLC
- AZZ / NLI
- Enertech, a business unit of Curtiss-Wright Flow Control Company

Pressure Vessel Analysis

- Joseph Oat Corporation
- Rolls-Royce

Pressure Vessels

- AT&F Nuclear, Inc, Division of AT & F Black & Veatch
- Ellis & Watts Global Industries, LLC.
- Energy Steel & Supply CO.
- Joseph Oat Corporation
- Oregon Iron Works, Inc
- Precision Custom Components, LLC
- Rolls-Royce
- Westerman Nuclear

Pressurizer Heater Maintenance

- Energy Steel & Supply CO.

Pressurizers

- Precision Custom Components, LLC

Primary-Side Piping

- Energy Steel & Supply CO.
- Precision Custom Components, LLC

Probabilistic Risk Assessment

- Diakont
- Fauske & Associates., LLC
- GE Hitachi Nuclear Energy
- HukariAscendent
- Poyry Energy Ltd., Century House
- Rolls-Royce
- Sargent & Lundy
- Sciencetech, a business unit of Curtiss-Wright Flow Control Company
- Structural Integrity Associates, Inc.

Probabilistic Risk Assessment: BWR

- Fauske & Associates., LLC
- HukariAscendent
- Poyry Energy Ltd., Century House
- Sciencetech, a business unit of Curtiss-Wright Flow Control Company

Probabilistic Safety Analysis

- Diakont
- EPM, Inc
- Fauske & Associates., LLC
- HukariAscendent
- Poyry Energy Ltd., Century House
- Sargent & Lundy
- Sciencetech, a business unit of Curtiss-Wright Flow Control Company
- VTT Technical Research Centre of Finland

Probes: Gamma

- Gammasonics Institute for Medical Research
- Mirion Technologies

Probes: Geiger-Mueller

- Mirion Technologies

Probes: Geiger-Mueller, End Window

- Biodex Medical Systems, Inc.

Probes: Geiger-Mueller, Pancake

- Biodex Medical Systems, Inc.

Probes: Traversing In-Core Gamma

- Mirion Technologies

Probes: Traversing In-Core Neutron

- Mirion Technologies

Procedure Development

- BHI Energy
- Human and Organizational Performance Improvement
- Sargent & Lundy
- The Delphi Groupe, Inc.

Procedure Development: Root Cause

- Conger & Elsea, Inc.
- Rolls-Royce

Process Control Systems

- Air Monitor Corp.
- Elan Technical Corporation
- Mirion Technologies
- Sargent & Lundy

Procurement

- CHAMPS Software, Inc.
- HukariAscendent
- Kinectrics Incorporated
- Rolls-Royce

Procurement Management

- Bechtel Power
- Black & Veatch
- CHAMPS Software, Inc.
- HukariAscendent
- Rolls-Royce

Professional Conferences

- WM Symposia, Ste 9-332

Project Management

- Bechtel Power
- BHI Energy
- Black & Veatch
- GE Hitachi Nuclear Energy
- HukariAscendent
- Kinectrics Incorporated
- Rolls-Royce
- Sargent & Lundy
- Studsvik, Inc
- The Delphi Groupe, Inc.
- The Shaw Group
- Zachry Nuclear Engineering, Inc

Protective Clothing Lease

- UniTech Services Group, Inc., Div. of Unifirst Corp.

Pump Analysis

- Black & Veatch
- Energy Steel & Supply CO.
- Fauske & Associates., LLC

Pump Overhauling

- Energy Steel & Supply CO.
- Enertech, a business unit of Curtiss-Wright
- Flow Control Company

Pump Overhauling: Turbine Driven

- Energy Steel & Supply CO.

Pump Parts

- AZZ / NLI
- Energy Steel & Supply CO.
- Enertech, a business unit of Curtiss-Wright
- Flow Control Company
- Flowsolve Engineered Products Division

Pump Seals

- Candu Energy Inc
- Flowsolve Engineered Products Division

Pump Service

- Energy Steel & Supply CO.
- Enertech, a business unit of Curtiss-Wright
- Flow Control Company
- Flowsolve Engineered Products Division

Pumps

- Aero-fin
- AZZ / NLI
- Energy Steel & Supply CO.
- Enertech, a business unit of Curtiss-Wright
- Flow Control Company
- Rolls-Royce

Pumps: Air Sampling

- HI-Q Environmental Products Company

Pumps: Auxiliary

- AZZ / NLI
- Energy Steel & Supply CO.

Pumps: Canned Motor

- Energy Steel & Supply CO.
- Enertech, a business unit of Curtiss-Wright
- Flow Control Company
- Peerless Electric

Pumps: Centrifugal

- Aero-fin
- Andritz Maschinenfabrik AG.
- AZZ / NLI
- Energy Steel & Supply CO.
- Enertech, a business unit of Curtiss-Wright
- Flow Control Company
- Flowsolve Engineered Products Division
- HI-Q Environmental Products Company
- Mechanical Equipment Company

Pumps: Circulating

- Aero-fin
- AZZ / NLI
- Energy Steel & Supply CO.

Pumps: Cooling

- Andritz Maschinenfabrik AG.
- AZZ / NLI
- Energy Steel & Supply CO.

Pumps: Liquid Ring

- Energy Steel & Supply CO.

Pumps: Mag Drive

- Energy Steel & Supply CO.
- Enertech, a business unit of Curtiss-Wright
- Flow Control Company

Pumps: Rebuilding

- Energy Steel & Supply CO.

Pumps: Repair

- Energy Steel & Supply CO.
- Enertech, a business unit of Curtiss-Wright
- Flow Control Company
- Flowsolve Engineered Products Division
- Mechanical Equipment Company

Pumps: Rotary Vane

- Energy Steel & Supply CO.
- HI-Q Environmental Products Company

Pumps: Safety-Related

- Andritz Maschinenfabrik AG.
- AZZ / NLI
- Energy Steel & Supply CO.
- Enertech, a business unit of Curtiss-Wright
- Flow Control Company
- Rolls-Royce

Pumps: Sampling

- HI-Q Environmental Products Company

Pumps: Vacuum

- Energy Steel & Supply CO.
- HI-Q Environmental Products Company

Qualification: Supplier

- DCS Systems Inc.
- Kinectrics Incorporated
- Nutherm International, Inc.
- Rolls-Royce

Quality Assurance

- American Crane & Equipment Corp.
- Bechtel Power
- Black & Veatch
- Bureau Veritas
- DCS Systems Inc.
- Howard L. Sobel, P.E.
- NPTS, Inc.
- Preferred Quality Services, Inc.
- Rolls-Royce
- Scientech, a business unit of Curtiss-Wright
- Flow Control Company

Quality Assurance Equipment

- Rolls-Royce

Quality Assurance Programs

- American Crane & Equipment Corp.
- HSB Global Standards
- Rolls-Royce

Quality Assurance Services

- Bureau Veritas
- DCS Systems Inc.
- International Quality Consultants, Inc.
- National Inspection & Consultants, LLC.
- Rolls-Royce
- Sargent & Lundy

- Scientech, a business unit of Curtiss-Wright
- Flow Control Company
- Theseus Professional Services, LLC
- URS Corporation

Quality Control Services

- Bureau Veritas
- International Quality Consultants, Inc.
- National Inspection & Consultants, LLC.
- Preferred Quality Services, Inc.
- Rolls-Royce
- Sargent & Lundy
- Scientech, a business unit of Curtiss-Wright
- Flow Control Company

Quality Improvement Programs

- Rolls-Royce
- Sargent & Lundy

Quality Management

- DCS Systems Inc.
- Rolls-Royce

R&D Nondestructive Services

- Rolls-Royce

R&D Services

- CTR Technical Services, Inc.
- Energy Steel & Supply CO.
- Herguth Laboratories
- Kinectrics Incorporated
- Rolls-Royce

R&D: Chemical Engineering

- Fauske & Associates., LLC

R&D: Chemistry

- Fauske & Associates., LLC
- Herguth Laboratories

R&D: Fluid Flow

- Fauske & Associates., LLC

R&D: Fluid Mechanics

- Fauske & Associates., LLC
- Wyle Laboratories, Inc.

R&D: Fuel

- Lightbridge Corporation

R&D: Heat Transfer

- Energy Steel & Supply CO.
- Fauske & Associates., LLC

R&D: Instrumentation/Control Systems

- AZZ / NLI
- CTR Technical Services, Inc.

R&D: Materials Performance

- Kinectrics Incorporated
- VTT Technical Research Centre of Finland

R&D: Nondestructive Testing

- Rolls-Royce

R&D: Radioactive Catalysts

- Fauske & Associates., LLC

R&D: Radwaste Disposal

- Oregon Iron Works, Inc
- VTT Technical Research Centre of Finland

R&D: Radwaste Treatment

- Kinectrics Incorporated

R&D: Reactor

- CTR Technical Services, Inc.

R&D: Reactor Safety

- CTR Technical Services, Inc.
- Fauske & Associates., LLC

R&D: Reactors

- CTR Technical Services, Inc.

R&D: Structural Mechanics

- Fauske & Associates., LLC

Racks: Storage

- AT&F Nuclear, Inc, Division of AT & F
- Energy Steel & Supply CO.
- Joseph Oat Corporation
- SKODA JS a.s.

Rad Shielded Insulation

- Performance Contracting Inc. (PCI)

Radiation Assessment

Sargent & Lundy

Radiation Control Systems

Gammasonics Institute for Medical Research

Radiation Detection/Monitoring Systems

Aware Electronics Corp.

BHI Energy

ENVINET GmbH

- Frham Safety Products, Inc.

Gammasonics Institute for Medical Research

Health Physics Instruments, Div. of Far West Technology

- HI-Q Environmental Products Company

- Mirion Technologies

ORTEC

Radiation Shielding Systems

- Ceradyne Boron Products

LANCS Industries Holdings, LLC.

MarShield, Div. of Mars Metal Company

- Oregon Iron Works, Inc

Transco Products Inc.

Walischmiller Engineering GmbH

Radiation Vehicle Monitoring Systems

Apantec LLC, North Penn Business Park

Gammasonics Institute for Medical Research

- Mirion Technologies

Radioactive Solid Waste Tank Remediation

- Ceradyne Boron Products

Radioactive Waste Recycling

Studsvik, Inc

Radiochemistry

Eberline Services Inc.

Radioisotopes

Steventon Stewart International Inc.

Radiological Protection Services

BHI Energy

DADE Moeller & Associated, Inc.

Eberline Services Inc.

- UniTech Services Group, Inc., Div. of Unifirst Corp.

Radiological Surveys

Eberline Services Inc.

- Mirion Technologies

Radon Detection Services

Gammasonics Institute for Medical Research

Radwaste

- Ceradyne Boron Products

- Kinectrics Incorporated

LANCS Industries Holdings, LLC.

- Oregon Iron Works, Inc

- Rolls-Royce

Studsvik, Inc

WMG, Inc.

Radwaste Analysis

- Kinectrics Incorporated

S.M. Stoller Corp.

Sargent & Lundy

Radwaste Compaction Equipment

Container Products Corporation

S&G Enterprises, Inc.

Waste Control Systems, Inc.

Radwaste Compaction: Supercompactor

Container Products Corporation

Radwaste Disposal Facility Construction

S.M. Stoller Corp.

Radwaste Disposal Services

NSSI/Recovery Services Inc.

Studsvik, Inc

WMG, Inc.

Radwaste Equipment

- American Crane & Equipment Corp.

- Diakont

Dufrane Nuclear Shielding, Inc.

- Oregon Iron Works, Inc

- Rolls-Royce

- Siempelkamp Nukleartechnik GmbH

- Westerman Nuclear

Radwaste Equipment: Intermediate-Level

- Oregon Iron Works, Inc

- Rolls-Royce

Radwaste Equipment: Low-Level

Container Products Corporation

- Oregon Iron Works, Inc

- Rolls-Royce

S&G Enterprises, Inc.

- Siempelkamp Nukleartechnik GmbH

- Westerman Nuclear

Radwaste Extrusion Systems

- Rolls-Royce

Radwaste Handling

- American Crane & Equipment Corp.

Konecranes Nuclear Equipment & Services

LLC

- Rolls-Royce

WMG, Inc.

Radwaste Incineration

- Rolls-Royce

Radwaste Incinerators: Refurbishment

- Rolls-Royce

Radwaste Management Services

- Rolls-Royce

Studsvik, Inc

WMG, Inc.

Radwaste Packaging

Container Products Corporation

Reef Industries, Inc.

- Rolls-Royce

WMG, Inc.

Radwaste Polybags

- Frham Safety Products, Inc.

LANCS Industries Holdings, LLC.

Reef Industries, Inc.

Radwaste Processing

Diversified Technologies Services, Inc.

- Rolls-Royce

Studsvik, Inc

WMG, Inc.

Radwaste Processing: Intermediate-Level

- Rolls-Royce

Radwaste Reduction System Design

- Rolls-Royce

- Siempelkamp Nukleartechnik GmbH

Studsvik, Inc

Radwaste Reduction Systems: Manufacture

Gammasonics Institute for Medical Research

Radwaste Supplies

- Frham Safety Products, Inc.

- Mohawk Industrial & Nuclear Supply, Inc.

Reef Industries, Inc.

Radwaste Tanks

- Energy Steel & Supply CO.

- Oregon Iron Works, Inc

- Rolls-Royce

- Westerman Nuclear

Radwaste Transportation

Barnhart

- Rolls-Royce

Radwaste Treatment Plants

- Rolls-Royce

- Siempelkamp Nukleartechnik GmbH

Radwaste Treatment Services

NSSI/Recovery Services Inc.

- Rolls-Royce

Studsvik, Inc

- UniTech Services Group, Inc., Div. of Unifirst Corp.

Radwaste Volume Reduction

Container Products Corporation

Diversified Technologies Services, Inc.

- Rolls-Royce

S&G Enterprises, Inc.

- Siempelkamp Nukleartechnik GmbH

Studsvik, Inc

Underwater Construction Corporation

- UniTech Services Group, Inc., Div. of Unifirst Corp.

Radwaste: Percent Solids Control

- Rolls-Royce

Radwaste: Percent Solids Measurement

- Rolls-Royce

Ratemeters: Alarming

Biodex Medical Systems, Inc.

Reactor Analysis Software

- Candu Energy Inc

Reactor Control Systems

- Rolls-Royce

Reactor Coolant Pump Services

- Rolls-Royce

Reactor Core Components

- Energy Steel & Supply CO.

- GE Hitachi Nuclear Energy

- Oregon Iron Works, Inc

Precision Custom Components, LLC

- Rolls-Royce

Reactor Core Design

CTR Technical Services, Inc.

- GE Hitachi Nuclear Energy

Utility Resource Associates

Reactor Core Structure

- Energy Steel & Supply CO.

- Oregon Iron Works, Inc

Precision Custom Components, LLC

Reactor Head Removal Services

- Bechtel Power

- Bigge Power Constructors

URS Corporation

Reactor Head Repair

Aquilex WSI Nuclear Services

Precision Custom Components, LLC

Reactor Head Tensioning Equipment

- Siempelkamp Nukleartechnik GmbH

SKODA JS a.s.

- Trust Manufacturing

Reactor Internals

- AT&F Nuclear, Inc, Division of AT & F

- Energy Steel & Supply CO.

- Oregon Iron Works, Inc

Precision Custom Components, LLC

- Rolls-Royce

SKODA JS a.s.

Reactor Internals Modification

- GE Hitachi Nuclear Energy

- Rolls-Royce

Reactor Internals Service

- Rolls-Royce

Reactor Protection Systems

- Rolls-Royce

- Scientech, a business unit of Curtiss-Wright

Flow Control Company

Thermo Scientific, NFMS Part of Thermo

Fisher Scientific

Reactor Repair

- Rolls-Royce

Reactor Repair: Underwater, BWR

Underwater Construction Corporation

Reactor Services

BHI Energy

- Rolls-Royce

- Scientech, a business unit of Curtiss-Wright

Flow Control Company

Underwater Construction Corporation

Reactor Vessel Components

- AT&F Nuclear, Inc, Division of AT & F

- Energy Steel & Supply CO.

- Oregon Iron Works, Inc

Precision Custom Components, LLC

- Rolls-Royce
- Trust Manufacturing

Reactor Vessel Repair
Aquillex WSI Nuclear Services

Reactors

- Rolls-Royce

Reactors: Advanced ABWR

- GE Hitachi Nuclear Energy

Reactors: Advanced Passive PWR

- Rolls-Royce

Reactors: Advanced PWR

- Rolls-Royce

Reactors: Advanced Systems, BWR

- Rolls-Royce

Reactors: BWR: Equipment Upgrades

- Rolls-Royce

Reactors: Engineering
CTR Technical Services, Inc.

- Rolls-Royce

Reactors: Generation 4 Advanced Designs

- GE Hitachi Nuclear Energy

Reactors: Heavy Water

- Candu Energy Inc
- Rolls-Royce
Steventon Stewart International Inc.

Reactors: Passive ESBWR

- GE Hitachi Nuclear Energy

Reactors: PWR

- Rolls-Royce

Records Management
S.M. Stoller Corp.
Sargent & Lundy

- Sciencetech, a business unit of Curtiss-Wright
Flow Control Company

Records Management Systems
Black & Veatch

Recovery: Asset

- Sciencetech, a business unit of Curtiss-Wright
Flow Control Company

Rectifiers

- AZZ / NLI

Recycling: Metals
Studsvik, Inc

Refacing Equipment: Flanges

- Tri Tool Inc.

Refrigerators: Lead-Lined
Biodex Medical Systems, Inc.

Refueling Equipment

- American Crane & Equipment Corp.
- Diakont
Konecranes Nuclear Equipment & Services LLC
- Sciencetech, a business unit of Curtiss-Wright
Flow Control Company
- Siempelkamp Nukleartechnik GmbH

Refueling Equipment: Refurbishing

- American Crane & Equipment Corp.
- Diakont
Konecranes Nuclear Equipment & Services LLC
- Sciencetech, a business unit of Curtiss-Wright
Flow Control Company

Registers

- AZZ / NLI

Regulatory Compliance
Black & Veatch
Golder Associates Ltd.

- HukariAscendent
- Rolls-Royce
- Sciencetech, a business unit of Curtiss-Wright
Flow Control Company
- URS Corporation
- WMG, Inc.

Regulatory Compliance: 10CFR50.59

- Bechtel Power
Black & Veatch
- Rolls-Royce

Regulatory Compliance: 10CFR50.65

- Rolls-Royce

Relays: Safety-Related

- AZZ / NLI
Nuthern International, Inc.
Wyle Laboratories, Inc.

Remediation

- HukariAscendent
- Rolls-Royce

Remediation Projects
Black & Veatch

- HukariAscendent
- Rolls-Royce
Studsvik, Inc

Remediation Services
BHI Energy
Black & Veatch
Eberline Services Inc.
Fuel Tank Maintenance Company LLC
Golder Associates Ltd.

- Rolls-Royce
Studsvik, Inc

Remote Handling Equipment

- American Crane & Equipment Corp.
Babcock Noell
- Diakont
Konecranes Nuclear Equipment & Services LLC
- Rolls-Royce
Siempelkamp Nukleartechnik GmbH
Walischmiller Engineering GmbH
WMG, Inc.

Remote Operated Vehicle

- Diakont

Repair Equipment: Remote-Controlled

- Diakont

Repair: Apparatus

- Schulz Electric Company

Repair: General Equipment

- American Crane & Equipment Corp.
BHI Energy
Cutsforth
- Schulz Electric Company

Repairs: Underwater
Underwater Construction Corporation

Reports: Certified Code

- Rolls-Royce

Resistance Temp. Detector Modifications

- Mirion Technologies
Temp-Pro Inc.

Resistance Temperature Detectors

- Mirion Technologies
Temp-Pro Inc.

Respirator Cleaning Equipment

- UniTech Services Group, Inc., Div. of Unifirst Corp.

Respirator Fit Testing

- Frham Safety Products, Inc.
- Rolls-Royce

Respirator Supply Systems

- Frham Safety Products, Inc.
- Rolls-Royce

Respirators
 Draeger Safety.Inc.

- Frham Safety Products, Inc.
- LANCS Industries Holdings, LLC.
- UniTech Services Group, Inc., Div. of Unifirst Corp.

Retubing

- Energy Steel & Supply CO.
Powerfect
- Rolls-Royce
- Westerman Nuclear

Review Support: Operational Readiness
BHI Energy
Black & Veatch
Conger & Elsea, Inc.

- HukariAscendent

Rigging
Barnhart

- Bigge Power Constructors
Fuel Tank Maintenance Company LLC
Hake Rigging Company

Rings: Backing

- Energy Steel & Supply CO.

Rings: Machined
Cutsforth

- Energy Steel & Supply CO.

Rings: Rolled

- Energy Steel & Supply CO.
- Trust Manufacturing

Risk Assessment
BHI Energy

- Fauske & Associates., LLC
- HukariAscendent
- Rolls-Royce
- Sciencetech, a business unit of Curtiss-Wright
Flow Control Company

Robotic Handling Equipment

- American Crane & Equipment Corp.
- Diakont
iRobot Corporation
PaR Systems, Inc.
- Rolls-Royce
Walischmiller Engineering GmbH

Robotic Programs: Utility, Devel. and Implem.

- Diakont
PaR Systems, Inc.

Robots and Robotic Equipment

- Candu Energy Inc
- Diakont
iRobot Corporation
PaR Systems, Inc.
Pentek, Inc.
R.O.V. Technologies, Inc.
- Rolls-Royce
Walischmiller Engineering GmbH

Rod Control Maintenance Services
Analysis and Measurement Services Corp.

- Sciencetech, a business unit of Curtiss-Wright
Flow Control Company

Rolled Sections: Metal Alloys

- Energy Steel & Supply CO.

Rope: Warning
Biodex Medical Systems, Inc.
Euclid Garment Manufacturing Company

- Frham Safety Products, Inc.
- UniTech Services Group, Inc., Div. of Unifirst Corp.

RTD Calibration Service
Analysis and Measurement Services Corp.

Rubber Products: Custom

- Seal Master Corporation

Safeguards
Argonne National Laboratory, Vulnerability Assessment Team
Black & Veatch

- HukariAscendent

Safes/Vaults: Lead Shielded
Biodex Medical Systems, Inc.

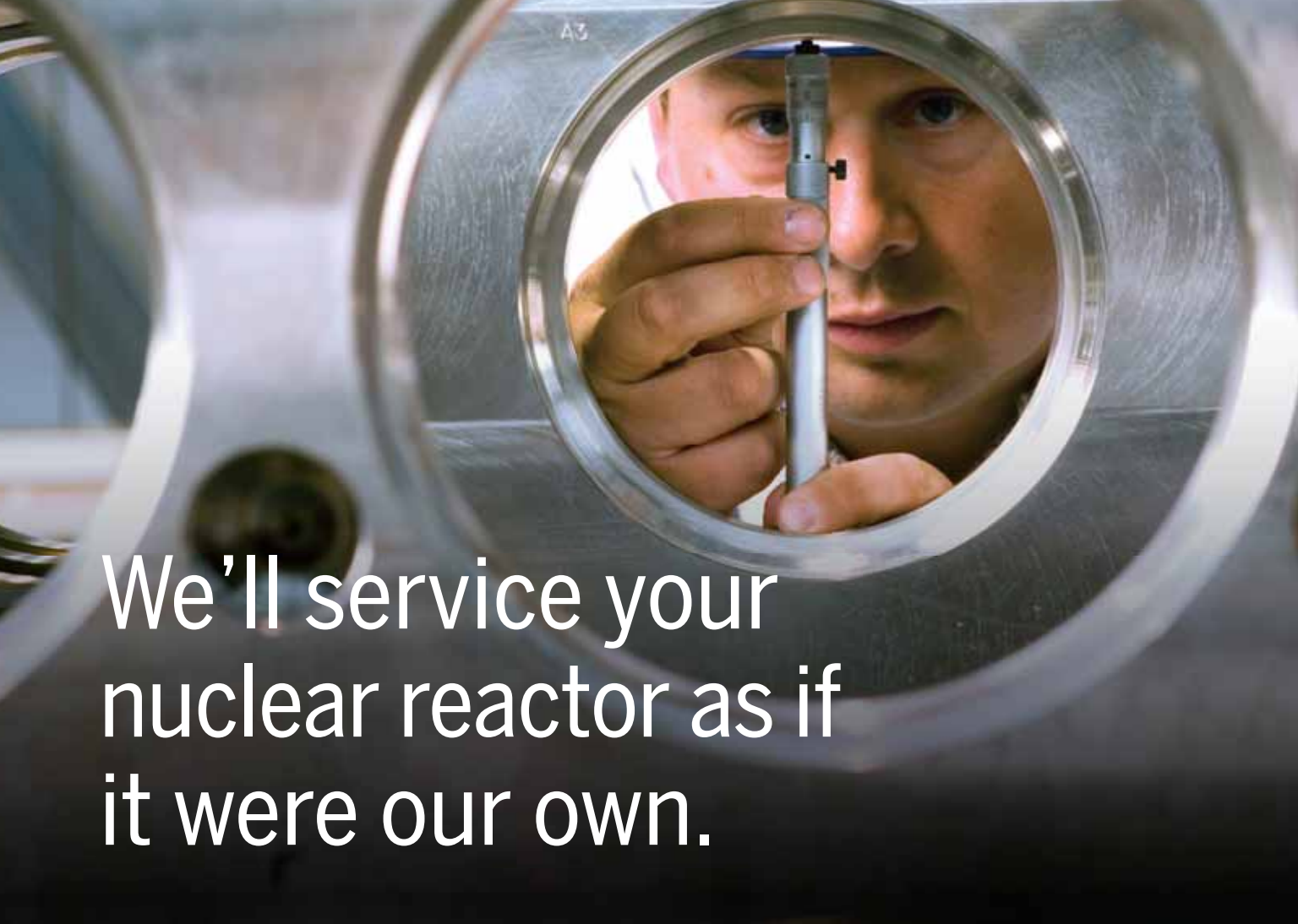

We'll service your nuclear reactor as if it were our own.

Our history of developing and designing reactors to produce safe nuclear energy dates back over 50 years. With such breadth of experience comes a level of expertise that proves invaluable in servicing both heavy and light water reactors.

Candu Energy is a choice that makes sense, from a reliability, innovation and business standpoint.

In our capacity as an original equipment manufacturer and through our affiliation with AECL, we offer a full suite of engineering and field services solutions that meet the highest safety and regulatory standards.

Look to Candu Energy for both heavy and light water plant management programs, life extension projects, as well as a full range of operational and maintenance services.

We design and build nuclear reactors. It just makes sense that we're the best choice to service and maintain them.

www.candu.com

Candu 
Powering prosperity.

Safety Analysis

- Candu Energy Inc
- CTR Technical Services, Inc.
- Fauske & Associates., LLC
- Poyry Energy Ltd., Century House
- Sargent & Lundy
- Sciencetech, a business unit of Curtiss-Wright
- Flow Control Company

Safety Assessment

- Black & Veatch
- Fauske & Associates., LLC
- Poyry Energy Ltd., Century House
- Sciencetech, a business unit of Curtiss-Wright
- Flow Control Company
- Zachry Nuclear Engineering, Inc

Safety Equipment

- American Safety Vest
- Frham Safety Products, Inc.
- Joseph Oat Corporation
- LANCS Industries Holdings, LLC.
- TECH Products, Inc.
- UniTech Services Group, Inc., Div. of Unifirst Corp.

Safety Evaluations: Preparation

- Black & Veatch
- Conger & Elsea, Inc.
- HukariAscendent
- Sargent & Lundy
- Zachry Nuclear Engineering, Inc

Safety Evaluations: Program Reviews

- Black & Veatch
- Conger & Elsea, Inc.
- HukariAscendent
- Sargent & Lundy
- The Shaw Group

Safety Management

- Atlantic Nuclear Services Inc.
- Black & Veatch
- HukariAscendent

Safety: Industrial

- BHI Energy
- Black & Veatch
- Conger & Elsea, Inc.
- Frham Safety Products, Inc.
- The Delphi Groupe, Inc.

Safety: Radiological

- BHI Energy
- Black & Veatch
- Frham Safety Products, Inc.
- Rolls-Royce
- The Delphi Groupe, Inc.

Sample Collection

- GEL Engineering LLC
- HI-Q Environmental Products Company
- Sentry Equipment Corp

Sampling Systems

- HI-Q Environmental Products Company
- Sentry Equipment Corp

Sampling Systems: Iso-Kinetic

- Air Monitor Corp.
- GEL Engineering LLC
- HI-Q Environmental Products Company
- Jonas, Inc.

Sawing

- Cutting Edge Services Corporation
- Cutting Technologies

Sabblers: Dustless Floor

- Pentek, Inc.

Scaffolding

- BHI Energy
- Excel Modular Scaffold & Leasing Corporation
- Safway Services, LLC
- The Shaw Group

Scaffolding Couplers

- Excel Modular Scaffold & Leasing Corporation

Scaffolding Design/Engineering Services

- BHI Energy
- Excel Modular Scaffold & Leasing Corporation
- Safway Services, LLC

Scaffolding Erection Services

- BHI Energy
- Excel Modular Scaffold & Leasing Corporation
- Safway Services, LLC

Scaffolding Maintenance

- Excel Modular Scaffold & Leasing Corporation

Scaffolding Rental

- BHI Energy
- Excel Modular Scaffold & Leasing Corporation
- Safway Services, LLC
- UniTech Services Group, Inc., Div. of Unifirst Corp.

Scaffolding: Fall Arrest Equipment

- Excel Modular Scaffold & Leasing Corporation

Scaffolding: Mast-Climbing

- Safway Services, LLC

Scaffolding: Planks/Grating

- Excel Modular Scaffold & Leasing Corporation

Scheduling

- Rolls-Royce
- URS Corporation

Scheduling Management

- Rolls-Royce

Scintillation Crystals

- Saint-Gobain Crystals
- Spectra Physics, Hilger Crystals Limited

Seal Enclosures: Custom

- Mirion Technologies

Sealing Systems: Quick-Disconnect

- Energy Steel & Supply CO.

Sealing: Penetration

- Mirion Technologies
- Transco Products Inc.

Seals

- Energy Steel & Supply CO.
- Seal Master Corporation

Seals: Bellows, Gate Valve

- Enertech, a business unit of Curtiss-Wright
- Flow Control Company
- Seal Master Corporation

Seals: Bellows, Globe Valve

- Enertech, a business unit of Curtiss-Wright
- Flow Control Company
- Seal Master Corporation

Seals: Conduit

- Mirion Technologies

Seals: Diaphragm

- Seal Master Corporation

Seals: Flat

- Seal Master Corporation

Seals: Inflatable

- Seal Master Corporation

Seals: Steam Generator

- Sciencetech, a business unit of Curtiss-Wright
- Flow Control Company

Security Booths

- Dufrane Nuclear Shielding, Inc.
- Par-Kut International, Inc.

Security Management

- Argonne National Laboratory, Vulnerability Assessment Team

Security System Design

- Carpeny And Associates., LLC
- Sargent & Lundy

- Zachry Nuclear Engineering, Inc

Security System Integrators

- Carpeny And Associates., LLC

Security System Upgrades

- Carpeny And Associates., LLC
- Fuel Tank Maintenance Company LLC
- Sargent & Lundy
- Zachry Nuclear Engineering, Inc

Security Systems

- Black & Veatch
- iRobot Corporation
- Sciencetech, a business unit of Curtiss-Wright
- Flow Control Company

Security: Hazards Analysis

- Black & Veatch
- Sargent & Lundy

Seismic Analysis

- AZZ / NLI
- Candu Energy Inc
- Enertech, a business unit of Curtiss-Wright
- Flow Control Company
- Fauske & Associates., LLC
- Joseph Oat Corporation
- Sargent & Lundy
- Schulz Electric Company
- Structural Integrity Associates, Inc.
- Zachry Nuclear Engineering, Inc

Seismic Analysis/Testing Equipment

- Black & Veatch
- Kinectrics Incorporated
- Sciencetech, a business unit of Curtiss-Wright
- Flow Control Company

Seismic Monitoring Equipment

- AZZ / NLI

Seismic Qualification

- AZZ / NLI
- Black & Veatch
- Energy Steel & Supply CO.
- Enertech, a business unit of Curtiss-Wright
- Flow Control Company
- Fauske & Associates., LLC
- Nutherm International, Inc.
- Oregon Iron Works, Inc
- Sargent & Lundy
- Schulz Electric Company
- SSM Industries, Inc.
- Wyle Laboratories, Inc.

Seminars: ASME Code

- Rolls-Royce

Sensors

- AZZ / NLI
- Energy Steel & Supply CO.
- Namco Controls

Sensors: Differential Pressure

- AZZ / NLI
- Enertech, a business unit of Curtiss-Wright
- Flow Control Company

Sensors: Flow

- AZZ / NLI
- Energy Steel & Supply CO.
- Enertech, a business unit of Curtiss-Wright
- Flow Control Company

Sensors: Fluid Level

- AZZ / NLI
- Enertech, a business unit of Curtiss-Wright
- Flow Control Company

Sensors: Level

- AZZ / NLI
- Delta M Corporation
- Energy Steel & Supply CO.
- Enertech, a business unit of Curtiss-Wright
- Flow Control Company

Sensors: Pressure

- AZZ / NLI
- C.J. Enterprises

- Energy Steel & Supply CO.
Enertech, a business unit of Curtiss-Wright
Flow Control Company

Sensors: Radiation Resistant

- C.J. Enterprises
Namco Controls

Sensors: Temperature

- Elan Technical Corporation
- Mirion Technologies
Temp-Pro Inc.
Weed Instrument Co., Inc d/b/a Ultra Electronics, NSPI

Separation: Solids

- Rolls-Royce

Separators

- Energy Steel & Supply CO.
Precision Custom Components, LLC
- Rolls-Royce
- Seal Master Corporation

Septa: Powdered Resin

- Enertech, a business unit of Curtiss-Wright
Flow Control Company

Shearing

- Chatham Steel Corporation

Sheet Copper

- TW Metals - Nuclear Materials Solutions

Sheet Copper Alloy

- TW Metals - Nuclear Materials Solutions

Sheet Metal

- Chatham Steel Corporation
- Energy Steel & Supply CO.
- SSM Industries, Inc.
Tioga Pipe Supply Company Inc.
- TW Metals - Nuclear Materials Solutions

Sheeting: Plastic

- Herculite Products
International Plastics, Inc.
Reef Industries, Inc.

Shell Penetrations

- Aquilex WSI Nuclear Services
- Energy Steel & Supply CO.
- Rolls-Royce

Shielding

- AT&F Nuclear, Inc, Division of AT & F
Biodex Medical Systems, Inc.
Dufrane Nuclear Shielding, Inc.
- Joseph Oat Corporation
LANCS Industries Holdings, LLC.
Nuclear Shielding Supplies & Service
- Rolls-Royce
- Siempelkamp Nukleartechnik GmbH

Shielding Analysis

- Candu Energy Inc
- Fauske & Associates., LLC
- Rolls-Royce
Sargent & Lundy
WMG, Inc.

Shielding Information: Nuclear

- Frontier Technology Corporation
Nuclear Shielding Supplies & Service
- Rolls-Royce

Shielding Materials

- Dufrane Nuclear Shielding, Inc.
Nuclear Shielding Supplies & Service
- TW Metals - Nuclear Materials Solutions

Shielding Materials: Gamma

- Dufrane Nuclear Shielding, Inc.
Nuclear Shielding Supplies & Service

Shielding Materials: Lead Glass

- Biodex Medical Systems, Inc.

Shielding Materials: Neutron

- Ceradyne Boron Products
- Frontier Technology Corporation
Nuclear Shielding Supplies & Service
Transco Products Inc.

Shielding Materials: Polyethylene-Base

- Dufrane Nuclear Shielding, Inc.

Shielding Windows

- Dufrane Nuclear Shielding, Inc.
- Siempelkamp Nukleartechnik GmbH

Shielding: Custom

- Biodex Medical Systems, Inc.
Dufrane Nuclear Shielding, Inc.
Nuclear Shielding Supplies & Service
Tri Nuclear Corporation

Shielding: Gamma

- Hopewell Designs, Inc.
Nuclear Shielding Supplies & Service
- Rolls-Royce

Shielding: High-Density Concrete

- Ceradyne Boron Products
Dufrane Nuclear Shielding, Inc.
Nuclear Shielding Supplies & Service
- Rolls-Royce

Shielding: Lead

- Biodex Medical Systems, Inc.
Dufrane Nuclear Shielding, Inc.
Hopewell Designs, Inc.
LANCS Industries Holdings, LLC.
- Rolls-Royce
Seafab Metal Company
Tri Nuclear Corporation

Shielding: Lead Bricks

- Biodex Medical Systems, Inc.
LANCS Industries Holdings, LLC.
- Rolls-Royce



SEAL MASTER
CUSTOM RUBBER PRODUCTS

Engineered
INFLATABLES

**SEALS, ACTUATORS, GRIPPERS
& PNEUMATIC SPECIALTIES**



**FABRIC-REINFORCED
FOR STRENGTH &
STRUCTURAL INTEGRITY**

"Technical expertise, enthusiasm, creative problem solving, unmatched experience and follow-through... that's Seal Master for sure!"

DESIGN ASSISTANCE OFFERED - WWW.SEALMASTER.COM

SEAL MASTER CORPORATION
368 MARTINEL DRIVE, KENT, OH 44240-4368 USA
(800) 477-8436 / (330) 673-8410 • FAX (330) 673-8242
E-mail: info@sealmaster.com

Serving the nuclear industry since 1974.

Fukushima Response

Where will you
mount the sensors?



Sciencetech's SFP-051 system is a set of powerful, durable, configurable solutions that fulfill all requirements of NRC Order EA 12-051. This complete system includes sensors, signal conditioning, SBO power source, displays, seismic mounts, documentation and plant analysis.

Call 208.524.9309 or email
sfp051@curtisswright.com

**CURTISS
WRIGHT**
Flow Control Company
SCIENTECH

Learn more at <http://sciencetech.cwfc.com>

Shielding: Lead Bricks/Blocks

- Dufrane Nuclear Shielding, Inc.
- Rolls-Royce
- Seafab Metal Company

Shielding: Lead Hot Pours

- Dufrane Nuclear Shielding, Inc.
- Hopewell Designs, Inc.
- Rolls-Royce

Shielding: Lead Pipe

- Rolls-Royce

Shielding: Lead Shot

- Rolls-Royce

Shielding: Lead-Plastic

- Dufrane Nuclear Shielding, Inc.

Shielding: Neutron

- Dufrane Nuclear Shielding, Inc.
- Nuclear Shielding Supplies & Service
- Rolls-Royce

Shielding: Portable

- Biodex Medical Systems, Inc.
- Dufrane Nuclear Shielding, Inc.
- LANCS Industries Holdings, LLC.
- Nuclear Shielding Supplies & Service
- Rolls-Royce
- Tri Nuclear Corporation

Shielding: Radiation

- Biodex Medical Systems, Inc.
- Ceradyne Boron Products
- Dufrane Nuclear Shielding, Inc.
- LANCS Industries Holdings, LLC.
- Nuclear Shielding Supplies & Service
- Rolls-Royce
- Tri Nuclear Corporation

Shielding: Sheet

- TW Metals - Nuclear Materials Solutions

Shielding: X-Ray

- Dufrane Nuclear Shielding, Inc.
- Gammasonics Institute for Medical Research
- Nuclear Shielding Supplies & Service

Shields: Bench-Top

- Biodex Medical Systems, Inc.

Shields: Lead Frisker

- Dufrane Nuclear Shielding, Inc.
- Tri Nuclear Corporation

Shields: Mobile

- Biodex Medical Systems, Inc.
- Dufrane Nuclear Shielding, Inc.
- LANCS Industries Holdings, LLC.

Shields: Mobile Lead

- Biodex Medical Systems, Inc.
- LANCS Industries Holdings, LLC.
- Tri Nuclear Corporation

Shipping Containers: Neutron Source

- Frontier Technology Corporation
- Rolls-Royce

Shoe Covers: Protective

- Euclid Garment Manufacturing Company
- Frham Safety Products, Inc.
- LANCS Industries Holdings, LLC.
- UniTech Services Group, Inc., Div. of Unifirst Corp.

Shredder/Compactors

- Waste Control Systems, Inc.

Signs: Warning

- American Safety Vest
- Biodex Medical Systems, Inc.
- Frham Safety Products, Inc.
- LANCS Industries Holdings, LLC.
- TECH Products, Inc.
- Uticom Systems Inc.

Simulator Training

- Tecnatom, S.A.

Simulators: Power Plant

- VTT Technical Research Centre of Finland

Skimmers

- Tri Nuclear Corporation

Sleeving

- Frham Safety Products, Inc.
- Reef Industries, Inc.
- UniTech Services Group, Inc., Div. of Unifirst Corp.

Sleeving Installation

- Aquilex WSI Nuclear Services

Sleeving: Laser Welded

- Oregon Iron Works, Inc.

Slings

- Rolls-Royce

Sludge Collectors

- Rolls-Royce
- Tri Nuclear Corporation

Sludge Filtration & Drying

- Rolls-Royce

Sludge Removal

- Diversified Technologies Services, Inc.
- Fuel Tank Maintenance Company LLC
- Rolls-Royce

Sludge Vessels

- Energy Steel & Supply CO.
- Rolls-Royce
- Tri Nuclear Corporation
- Westerman Nuclear

Snubber Analysis

- Sargent & Lundy

Snubber Repair

- Enertech, a business unit of Curtiss-Wright
- Flow Control Company
- Wyle Laboratories, Inc.

Snubber Testing

- Enertech, a business unit of Curtiss-Wright
- Flow Control Company
- Wyle Laboratories, Inc.

"Our
commitment
for the excellence"



- INSPECTION & STRUCTURAL INTEGRITY
- TESTING: SYSTEMS & COMPONENTS OPERABILITY
- PLANT OPERATION SUPPORT
- TRAINING CENTERS
- DEVELOPING, MANUFACTURING AND DELIVERY OF EQUIPMENT & SYSTEMS
- SAFETY MANAGEMENT
- NEW NUCLEAR PROJECTS:
 - AP1000, ESBWR, ABWR, PBMR, CPR1000
 - ITER, JHR



www.tecnatom.es

Snubbers: Hydraulic

Enertech, a business unit of Curtiss-Wright
Flow Control Company
Liseiga Inc., (Sub. of Liseiga AG)

Sodium Iodide Crystals

Saint-Gobain Crystals

Software

CHAMPS Software, Inc.
• Fauske & Associates., LLC
• Rolls-Royce
Sargent & Lundy
Standish Technologies, International

Software Development

Analysis and Measurement Services Corp.
CHAMPS Software, Inc.
• Diakont
• Fauske & Associates., LLC
• Mirion Technologies
• Rolls-Royce
Sargent & Lundy
Standish Technologies, International
• Trust Manufacturing
Volian Enterprises, Inc.
• Zachry Nuclear Engineering, Inc

Software Validation

• AZZ / NLI
CTR Technical Services, Inc.
• Fauske & Associates., LLC
• Zachry Nuclear Engineering, Inc

Software Verification

• AZZ / NLI
CTR Technical Services, Inc.
• Fauske & Associates., LLC
• Zachry Nuclear Engineering, Inc

Software: Reactor Analysis

• Candu Energy Inc

Software: Computer Graphics/Simulation

• Rolls-Royce

Software: Control Computer

• Candu Energy Inc

Software: Custom

CHAMPS Software, Inc.
CTR Technical Services, Inc.
• Fauske & Associates., LLC
Research Software Consulting Group, Inc.
• Rolls-Royce
Sargent & Lundy
Standish Technologies, International
Volian Enterprises, Inc.

Software: Database Management

Sargent & Lundy
Volian Enterprises, Inc.

Software: Document Control

Sargent & Lundy

Software: Engineering Applications

EPM, Inc
Sargent & Lundy

Software: Environmental Monitoring

ENVINET GmbH

Software: Fault Tree Analysis

Conger & Elsea, Inc.

Software: Fuel Management

• GE Hitachi Nuclear Energy

Software: Health Physics

• Mirion Technologies

Software: Inventory Management

CHAMPS Software, Inc.
Sargent & Lundy

Software: Maintenance

CHAMPS Software, Inc.
CORE, Inc.
Sargent & Lundy

Software: Materials Management

CHAMPS Software, Inc.

Software: Nuclear Safety

• Sciencetech, a business unit of Curtiss-Wright
Flow Control Company

Software: Operational Readiness

Conger & Elsea, Inc.

Software: Personnel Monitoring

• Mirion Technologies

Software: Plant Modeling

Sargent & Lundy
• Zachry Nuclear Engineering, Inc

Software: Plant Performance

Power & Energy Systems Services
• Sciencetech, a business unit of Curtiss-Wright
Flow Control Company
• Zachry Nuclear Engineering, Inc

Software: Power Systems Analysis

• Zachry Nuclear Engineering, Inc

Software: Probabilistic Safety Analysis

• Diakont
• Sciencetech, a business unit of Curtiss-Wright
Flow Control Company

Software: Process Control

• Zachry Nuclear Engineering, Inc

Software: Project Management

CHAMPS Software, Inc.

Software: Quality Assurance

Theseus Professional Services, LLC

Software: Radiological Data Management

WMG, Inc.

Software: Reliability Analysis

CORE, Inc.

Software: Remote Handling

• Rolls-Royce

Software: Robotic System

• Rolls-Royce

Software: Root Cause Analysis

Conger & Elsea, Inc.

Solenoid Operated Valve Applications

• AZZ / NLI
Enertech, a business unit of Curtiss-Wright
Flow Control Company
Valcor Engineering Corporation

Solenoid Operated Valve Diagnostics

Valcor Engineering Corporation

Solenoid Operated Valve Repair

Enertech, a business unit of Curtiss-Wright
Flow Control Company
Valcor Engineering Corporation

Solenoids

• AZZ / NLI
Enertech, a business unit of Curtiss-Wright
Flow Control Company
Valcor Engineering Corporation
Wyle Laboratories, Inc.

Sorbents

• Frham Safety Products, Inc.

Sources: Radioactive

Eberline Services Inc.
• Frontier Technology Corporation
Steventon Stewart International Inc.

Spectrometry: Mass, Secondary Ion

Mass Spec Services

Spectroscopy Systems

ENVINET GmbH
• Mirion Technologies

Spectroscopy Systems: Alpha

• Mirion Technologies
ORTEC

Spectroscopy Systems: Computer-Based

BHI Energy

Spectroscopy Systems: Gamma

ENVINET GmbH
• Mirion Technologies
ORTEC

Spectroscopy: Gamma

ENVINET GmbH
• Mirion Technologies

Spectroscopy: Neutron

• Mirion Technologies
Rogante Engineering Office

Spent Fuel Pool: Auxiliary Cooling

Enertech, a business unit of Curtiss-Wright
Flow Control Company
• Sciencetech, a business unit of Curtiss-Wright
Flow Control Company

Spent Fuel Storage Products

• American Crane & Equipment Corp.
• AT&F Nuclear, Inc, Division of AT & F
• Candu Energy Inc
• Holtec International
• Oregon Iron Works, Inc
Precision Custom Components, LLC

Spent Fuel Technology

• American Crane & Equipment Corp.
• Sciencetech, a business unit of Curtiss-Wright
Flow Control Company

Spent Fuel: Reracking

• American Crane & Equipment Corp.
• Sciencetech, a business unit of Curtiss-Wright
Flow Control Company
Underwater Construction Corporation

Spill Control

JRM Chemical, Inc.

Cf-252

Neutron Sources

- Sources to 3.7 mg.
- Custom Sources
- Quality Sources for Industry, Research & Reactor Start-Up
- Also Available:
SbBe Pellets & Sources
Neutron-Source Shipping Containers – TYPE A – for Rental or Purchase
WEP Shielding

FRONTIER TECHNOLOGY CORPORATION

P.O. Box 486
1641 Burnett Drive
Xenia, Ohio 45385
Tel: (937) 376-5691
Fax: (937) 376-5692
www.frontier-cf252.com

NPJ Delivers More! Highest Circulation

- Nuclear Plant Journal, being focused on nuclear power industry provides the best Return on Investment (ROI) on the advertising dollars.
- The Journal's total circulation is 12,000 which is the highest amongst the publications targeted to the nuclear power industry.
- The Journal provides technical information exchange amongst managers and engineers in the nuclear power industry worldwide.
- *The Journal is the only BPA audited publication in its industry*

Buy 2013 Advertising Space at 2012 Rates

Advertisers whose commitments are received before January 18, 2013 will be billed at the 2012 rates for 2013 advertising.

Nuclear Plant Journal
1400 Opus Place, Suite 904
Downers Grove, IL 60515
Phone: (630) 858-6161, ext. 103
Fax: (630) 852-8787
E-mail: michelle@goinfo.com
www.nuclearplantjournal.com.



G.D. Barri & Associates, Inc.
6860 W. Peoria Ave
Peoria, AZ 85345
623-773-0410 (P) 623-773-2924 (F)
www.gdbarri.com

G.D. Barri & Associates (Barri) is celebrating over 22 years in business. We have worked with 80 oil, gas, wind, combined cycles and solar plants, 51 nuclear units and 16 DOE nuclear sites. We have provided over 9MM hours of contract technical, engineering and union craft labor. Our projects include many types of engineering services, outage support, EPU, SGR, training, procedure development, digital asset engineering, and most recently cyber security staff support. Our management and national recruiting team has extensive nuclear/power knowledge that translates into value added, fresh processes and ideas to achieve client goals. The benefit of our experience is sure to be evidenced in your upcoming new programs. Our successful past and present makes us the best choice for a staffing partner when looking to the future. Please call either Georgia Barri or Rick Duff at 623 773 0410 to learn more regarding our programs and services. We presently have openings nationwide.

Spring Rings: Piston Ring Type

- Energy Steel & Supply CO.

Springs: High-Temperature

- Energy Steel & Supply CO.

Staff Augmentation—See Staff Support

- G.D. Barri & Associates, Inc.
- Sciencetech, a business unit of Curtiss-Wright Flow Control Company

Staff Support

- BHI Energy
- NPTS, Inc.
- RCM Technologies, Inc.
- Sargent & Lundy
- URS Corporation

Staff Support: 10CFR20 Implementation

- The Delphi Groupe, Inc.

Staff Support: Craft Labor

- BHI Energy
- Black & Veatch
- Schulz Electric Company

Staff Support: Decontamination

- BHI Energy

Staff Support: Designers

- Rolls-Royce
- Sargent & Lundy

Staff Support: Drafters

- Rolls-Royce

Staff Support: Engineering

- American Crane & Equipment Corp.
- BHI Energy
- Black & Veatch
- CTR Technical Services, Inc.
- DCS Systems Inc.
- Fauske & Associates., LLC
- ILD, Inc.
- Rolls-Royce
- Sargent & Lundy
- The Delphi Groupe, Inc.
- WMG, Inc.

Staff Support: Environmental Technologies

- BHI Energy
- GEL Engineering LLC
- S.M. Stoller Corp.

Staff Support: Executive

- Sargent & Lundy

Staff Support: Health Physics

- BHI Energy
- The Delphi Groupe, Inc.
- UniTech Services Group, Inc., Div. of Unifirst Corp.

Staff Support: Industrial Hygiene

- The Delphi Groupe, Inc.

Staff Support: Instrument Calibration

- G.D. Barri & Associates, Inc.

Staff Support: Instrumentation/Control

- BHI Energy
- Sargent & Lundy

Staff Support: Laundry Collection

- UniTech Services Group, Inc., Div. of Unifirst Corp.

Staff Support: Licensing

- Rolls-Royce
- WMG, Inc.

Staff Support: Modifications

- G.D. Barri & Associates, Inc.
- Sargent & Lundy

Staff Support: Nondestruction Examination

- American Crane & Equipment Corp.

Staff Support: Operational Readiness Review

- Black & Veatch

Staff Support: Outage

- American Crane & Equipment Corp.
- Aquilex WSI Nuclear Services
- BHI Energy
- G.D. Barri & Associates, Inc.

- Rolls-Royce
Sargent & Lundy
- Siempelkamp Nukleartechnik GmbH
The Delphi Groupe, Inc.
- UniTech Services Group, Inc., Div. of Unifirst Corp.

Staff Support: Planners

- BHI Energy
- G.D. Barri & Associates, Inc.
- HukariAscendent
- Rolls-Royce
Sargent & Lundy

Staff Support: Quality Assurance/Control

- BHI Energy
- DCS Systems Inc.
- HukariAscendent
- National Inspection & Consultants, LLC.
- Rolls-Royce
Sargent & Lundy

Staff Support: Radiological

- BHI Energy
- HukariAscendent
- Rolls-Royce
WMG, Inc.

Staff Support: Schedulers

- BHI Energy
- G.D. Barri & Associates, Inc.
- HukariAscendent
- Rolls-Royce

Staff Support: Specialists

- BHI Energy
- DCS Systems Inc.
- G.D. Barri & Associates, Inc.
- HukariAscendent
- Rolls-Royce

Staff Support: Technical

- Applied Analysis Corp.
- BHI Energy

- CTR Technical Services, Inc.
- DCS Systems Inc.
- G.D. Barri & Associates, Inc.
- HukariAscendent
- Rolls-Royce
Sargent & Lundy

Staff Support: Technical Staff

- BHI Energy
- DCS Systems Inc.
- G.D. Barri & Associates, Inc.
- HukariAscendent
- Rolls-Royce

Standards: Calibration

- Air Liquide America Specialty Gases, LLC
- Rolls-Royce

Standards: Radioactive

- Rolls-Royce

Standards: Reference

- Air Liquide America Specialty Gases, LLC

Standby Gas Treatment Systems

- AAF International
- NUCON International, Inc.

Steam Dryer Analysis

- GE Hitachi Nuclear Energy

Steam Dryers

- GE Hitachi Nuclear Energy

Steam Generator Chemical Cleaning

- Candu Energy Inc

Steam Generator Disposal

- Studsvik, Inc

Steam Generator Maintenance

- Rolls-Royce

Steam Generator Maintenance Equipment

- Scientech, a business unit of Curtiss-Wright
- Flow Control Company

Steam Generator Replacement

- Aquilex WSI Nuclear Services
- Bechtel Power
- URS Corporation

Steam Generators

- Oregon Iron Works, Inc
- Precision Custom Components, LLC
- Western United Industries

Steam/Water Separators

- Joseph Oat Corporation
- Precision Custom Components, LLC

Steel Components

- American Crane & Equipment Corp.
- AT&F Nuclear, Inc, Division of AT & F
- Energy Steel & Supply CO.
- Penn Iron Works, Inc.

Steel: Carbon

- American Crane & Equipment Corp.
- Chatham Steel Corporation
- Energy Steel & Supply CO.
- Rolls-Royce
- Steel Dynamics Roanoke Bar Division
- Tioga Pipe Supply Company Inc.
- TW Metals - Nuclear Materials Solutions

Steel: Stainless

- American Crane & Equipment Corp.
- Chatham Steel Corporation
- Energy Steel & Supply CO.
- Oregon Iron Works, Inc
- Rolls-Royce
- Tioga Pipe Supply Company Inc.
- Trust Manufacturing
- TW Metals - Nuclear Materials Solutions

Stop Gates

- Energy Steel & Supply CO.
- Oregon Iron Works, Inc



Responsive, Accountable, Reliable, Effective

**RARE
refinement.**

Providing safety-critical steel products to the nuclear industry.



ASME Quality System Certificate (QSC) applies to Chatham Steel's Durham, North Carolina location. ISO 9001:2008 accreditation applies to all Chatham Steel locations except Ironton, Ohio, which is scheduled for certification in 2012. Safety-critical steel products provided to the nuclear industry come from our Durham, North Carolina and Savannah, Georgia locations. A member of the Rollcast Steel and Aluminum family of companies.



Chatham Steel
corporation
CARBON • STAINLESS • ALLOY

Within the nuclear industry, there's a new and rare alternative for safety-critical needs...Chatham Steel. With 97 years of business behind our name, we don't deliver anything short of responsive, accountable, reliable and effective service for our customers. It's what has earned us our reputation for excellence in the metals service industry. That is what we believe to be refinement at its best.

For more information on our extensive inventory of steel products and processing services, call **1-800-869-2762** and ask for a nuclear sales specialist, email us at **nuclear@chathamsteel.com** or visit us online at **www.chathamsteel.com**.



Storage Facilities

Dufrane Nuclear Shielding, Inc.

Storage Systems: Onsite

Diversified Technologies Services, Inc.
 Dufrane Nuclear Shielding, Inc.
 Reef Industries, Inc.

Storage: Spent Fuel

- Energy Steel & Supply CO.
- Joseph Oat Corporation
- Precision Custom Components, LLC
- TransWare Enterprises Inc.

Strainers: Liquid

- Energy Steel & Supply CO.
- Rolls-Royce

Strainers: Self-Cleaning

- Aerofin
- Energy Steel & Supply CO.
- Enertech, a business unit of Curtiss-Wright
- Flow Control Company

Strainers: Suppression Pool ECCS

- Energy Steel & Supply CO.
- Enertech, a business unit of Curtiss-Wright
- Flow Control Company
- GE Hitachi Nuclear Energy
- Performance Contracting Inc. (PCI)
- Transco Products Inc.

Strippable Coatings

BHI Energy

Structural Integrity Assessment

Sargent & Lundy

Stud Handling

- Siempelkamp Nukleartechnik GmbH

Stud Refurbishment

- Siempelkamp Nukleartechnik GmbH
- Trust Manufacturing

Stud Removal

- Siempelkamp Nukleartechnik GmbH

Stud Tensioning Systems

- Scientech, a business unit of Curtiss-Wright
- Flow Control Company
- Siempelkamp Nukleartechnik GmbH
- Superbolt Inc.
- Trust Manufacturing

Stud Tensioning: Pressure Vessel

- Siempelkamp Nukleartechnik GmbH
- Trust Manufacturing

Studs

- Energy Steel & Supply CO.
- Niagara Fasteners Inc.
- Trust Manufacturing
- TW Metals - Nuclear Materials Solutions

Supplies: Asbestos Removal

LANCS Industries Holdings, LLC.

Support Services: Operating Plant

BHI Energy
 Sargent & Lundy

Surveillance Systems

- Diakont
- Preferred Quality Services, Inc.

Surveillance: Motor Load

- Schulz Electric Company

Surveillance: Vendor

DCS Systems Inc.

Swipes: Decontamination

LANCS Industries Holdings, LLC.
 Mohawk Industrial & Nuclear Supply, Inc.
 UniTech Services Group, Inc., Div. of Unifirst Corp.

Switchboards: Safety-Related

- AZZ / NLI
- Nuthern International, Inc.
- Scientech, a business unit of Curtiss-Wright
- Flow Control Company

Switches: Differential Pressure

- AZZ / NLI
- Nuthern International, Inc.

Switches: Flow

- AZZ / NLI
- Delta M Corporation
- Energy Steel & Supply CO.
- Enertech, a business unit of Curtiss-Wright
- Flow Control Company
- Fluid Components International (FCI)

Switches: Level

- AZZ / NLI
- Delta M Corporation
- Energy Steel & Supply CO.
- Enertech, a business unit of Curtiss-Wright
- Flow Control Company
- Fluid Components International (FCI)
- Nuthern International, Inc.

Switches: Limit

- AZZ / NLI
- Energy Steel & Supply CO.
- Namco Controls
- Nuthern International, Inc.
- Wyle Laboratories, Inc.

Switches: Limit, Flux Mapping

- Energy Steel & Supply CO.

Switches: Pressure

- AZZ / NLI
- C.J. Enterprises
- Enertech, a business unit of Curtiss-Wright
- Flow Control Company
- Nuthern International, Inc.

Switches: Pressure, Safety-Related

- AZZ / NLI
- Enertech, a business unit of Curtiss-Wright
- Flow Control Company



The Industry Leader with GSI-191 Compliance Solutions

LARGE FLUME TEST PROTOCOL (LFTP):

NOW ACCEPTED BY NRC

Qualification With More Debris Settlement Is Now Possible!

SURE-TRAP™ STRAINER PRE-SCREEN SYSTEM NEW

Add Sure-Trap™ To Your Existing Strainers To Reduce Debris Bypass



SURE-FLOW® STRAINERS

Still the Industry Benchmark For Strainer Performance

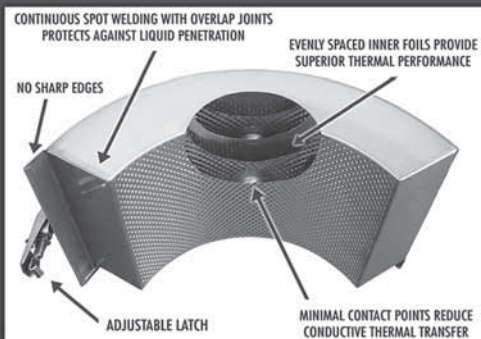

REFLECTIVE METAL INSULATION (RMI)

Now The Best RMI In The World Is Made In Kansas City, USA!



UP TO 30% BETTER THERMAL PERFORMANCE!



We Offer A Full Line of Non-Lead Radiation Barriers Now In NUKON® or RMI Systems!

Call: (913) 928-2800 | Visit: www.PCGESG.com

Email: ESGsales@pcg.com



APPENDIX B METALS • SAFETY-RELATED MATERIAL • METAL FABRICATION • NUKON® BLANKETS

Nutherm International, Inc.
 • Scientech, a business unit of Curtiss-Wright
 Flow Control Company
 Wyle Laboratories, Inc.

Switches: Speed

Nutherm International, Inc.

Switches: Temperature, Safety-Related

• AZZ / NLI
 Enertech, a business unit of Curtiss-Wright
 Flow Control Company
 Nutherm International, Inc.
 • Scientech, a business unit of Curtiss-Wright
 Flow Control Company
 Wyle Laboratories, Inc.

Switches: Thermocouple

Wyle Laboratories, Inc.

Switchgear

• AZZ / NLI
 Nutherm International, Inc.

Switchgear Maintenance

• AZZ / NLI

Switchgear: Safety-Related

• AZZ / NLI
 Nutherm International, Inc.
 • Scientech, a business unit of Curtiss-Wright
 Flow Control Company
 Wyle Laboratories, Inc.

Systems: Filtration

• AAF International
 • Rolls-Royce

Systems: Gas Processing

• NUCON International, Inc.

Systems: HVAC

• AAF International
 • AZZ / NLI
 • Rolls-Royce
 • SSM Industries, Inc.

Systems: Mixing

• Rolls-Royce

Systems: Pumping

• Rolls-Royce

Tags

• Frham Safety Products, Inc.
 Uticom Systems Inc.

Tank Heating Products

• Energy Steel & Supply CO.
 Enertech, a business unit of Curtiss-Wright
 Flow Control Company
 • Schulz Electric Company

Tanks: Chemical

• Energy Steel & Supply CO.
 Precision Custom Components, LLC
 • Westerman Nuclear

Tanks: Ion Exchange

• Energy Steel & Supply CO.
 Enertech, a business unit of Curtiss-Wright
 Flow Control Company
 • Oregon Iron Works, Inc
 • Rolls-Royce

Tanks: Pressure

• Aerofin
 • AZZ / NLI
 • Ellis & Watts Global Industries, LLC.
 • Energy Steel & Supply CO.
 Greenberry Fabrication
 • Joseph Oat Corporation
 • Oregon Iron Works, Inc
 Penn Iron Works, Inc.
 Precision Custom Components, LLC
 • Rolls-Royce
 • Westerman Nuclear

Tanks: Stainless Steel

• AZZ / NLI
 • Ellis & Watts Global Industries, LLC.
 • Energy Steel & Supply CO.

Enertech, a business unit of Curtiss-Wright
 Flow Control Company

• Oregon Iron Works, Inc
 Penn Iron Works, Inc.
 Precision Custom Components, LLC
 • Rolls-Royce
 Tri Nuclear Corporation
 • Westerman Nuclear

Tanks: Storage

• AZZ / NLI
 • Energy Steel & Supply CO.
 • Joseph Oat Corporation
 Mechanical Equipment Company
 • Oregon Iron Works, Inc
 Penn Iron Works, Inc.
 Precision Custom Components, LLC
 • Rolls-Royce
 • Westerman Nuclear

Tanks: Storage, Collapsible

• Energy Steel & Supply CO.

Tape: Duct

• Frham Safety Products, Inc.
 LANCS Industries Holdings, LLC.
 • UniTech Services Group, Inc., Div. of Unifirst
 Corp.

Tape: Electrical

• AZZ / NLI

Tape: Hook & Loop

• Frham Safety Products, Inc.

Tape: Warning

Euclid Garment Manufacturing Company
 • Frham Safety Products, Inc.
 International Plastics, Inc.
 • UniTech Services Group, Inc., Div. of Unifirst
 Corp.

Tarps

• Frham Safety Products, Inc.
 Herculite Products

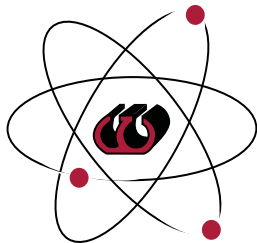

Westerman Nuclear World Class

NQA-1 and ISO 9001/2000

10 CFR 50 APPENDIX B

ASME SECTION III & VIII

Nuclear Subassemblies
 Reactor Components

Radwaste Containers
 Pressure Vessels

Material Certifications
 Heat Exchangers



800-338-8265

www.westermancompanies.com

**Westerman
Companies**

Westerman Nuclear LLC is a wholly owned
 subsidiary of the Westerman Companies

Dedicated to
QUALITY PRODUCTS
 and **SERVICE** since 1909

- International Plastics, Inc.
- LANCS Industries Holdings, LLC.
- UniTech Services Group, Inc., Div. of Unifirst Corp.

Technical Management Services

- Bechtel Power
- Black & Veatch

Technology Transfer

- Applied Analysis Corp.
- Rolls-Royce
- Sargent & Lundy

Telemetry Systems

- Mirion Technologies

Telerobotics

- American Crane & Equipment Corp.
- Diakont
- Rolls-Royce

Television Systems: Closed-Circuit

- Diakont
- Mirion Technologies
- Thermo Scientific-CIDTEC, (Part of Thermo Fisher Scientific)

Television Systems: Rad Hardened

- Diakont
- Mirion Technologies
- Thermo Scientific-CIDTEC, (Part of Thermo Fisher Scientific)

Television Systems: Underwater, Rad Hardened

- Diakont
- Mirion Technologies
- R.O.V. Technologies, Inc.
- Thermo Scientific-CIDTEC, (Part of Thermo Fisher Scientific)

Tensioning Rings: Hand-Hole

- Scientech, a business unit of Curtiss-Wright Flow Control Company
- Siempelkamp Nukleartechnik GmbH

Tensioning Rings: Manway

- Scientech, a business unit of Curtiss-Wright Flow Control Company
- Siempelkamp Nukleartechnik GmbH

Terminal Blocks: Safety-Related

- AZZ / NLI
- Nutherm International, Inc.
- Wyle Laboratories, Inc.

Terminals: Safety-Related

- AZZ / NLI
- Nutherm International, Inc.

Test Chambers: Environmental

Quanta Laboratories

Test Loops

- Energy Steel & Supply CO.
- Wyle Laboratories, Inc.

Test Stands: Valve

Wyle Laboratories, Inc.

Tester: Metal Hardness

- Rolls-Royce

Testing

- Black & Veatch
- Energy Steel & Supply CO.
- Engineering Mechanics Corporation of Columbus
- Rolls-Royce
- Wyle Laboratories, Inc.

Testing: Acceptance

- American Crane & Equipment Corp.
- Mass Spec Services
- NUCON International, Inc.
- Quanta Laboratories
- Rolls-Royce
- Scientech, a business unit of Curtiss-Wright Flow Control Company

Testing: Acoustic Emission

- Fauske & Associates., LLC

Testing: Chemical

- Chemetrics, Inc.
- Fauske & Associates., LLC
- Herguth Laboratories
- Kinectrics Incorporated
- Laboratory Services
- Laboratory Testing Inc.
- M+P Lab

Testing: Electrical

- Kinectrics Incorporated
- Rolls-Royce
- Schulz Electric Company
- Ultimate Power Solutions
- Wyle Laboratories, Inc.

Testing: Electrochemical

- Rolls-Royce

Testing: Electromagnetic Capability

Analysis and Measurement Services Corp.

Testing: EM1/RF1

Analysis and Measurement Services Corp.

Testing: Infrared

- Schulz Electric Company

Testing: Laboratory

- Engineering Mechanics Corporation of Columbus
- Fauske & Associates., LLC
- Herguth Laboratories
- Kinectrics Incorporated
- Laboratory Testing Inc.
- M+P Lab
- R&G Laboratories, Inc
- Wyle Laboratories, Inc.

Testing: LOCA Conditions

- AZZ / NLI
- Fauske & Associates., LLC
- Nutherm International, Inc.
- Wyle Laboratories, Inc.

Testing: Mechanical

- Energy Steel & Supply CO.
- Engineering Mechanics Corporation of Columbus
- Fauske & Associates., LLC
- Kinectrics Incorporated
- Laboratory Testing Inc.
- M+P Lab
- Quanta Laboratories
- Rolls-Royce
- Wyle Laboratories, Inc.

Testing: Mechanical & Irradiation

Wyle Laboratories, Inc.

Testing: Mechanical, Fatigue

Quanta Laboratories

Testing: Mechanical, Fracture

Quanta Laboratories

Testing: Metallurgical

- Laboratory Services
- Laboratory Testing Inc.
- M+P Lab

Testing: Organic

- Fauske & Associates., LLC

Testing: Plant Operation

- Fauske & Associates., LLC

Testing: Plant Operational

- Fauske & Associates., LLC

Testing: Remote Visual

- Rolls-Royce

Testing: Safety-Related Components

- American Crane & Equipment Corp.
- AZZ / NLI
- Fauske & Associates., LLC
- NUCON International, Inc.
- Nutherm International, Inc.
- Rolls-Royce
- Schulz Electric Company
- Scientech, a business unit of Curtiss-Wright Flow Control Company

- Ultimate Power Solutions
- Wyle Laboratories, Inc.

Testing: Special

- Fauske & Associates., LLC
- Herguth Laboratories
- ILLD, Inc.
- Wyle Laboratories, Inc.

Thermal Plume Studies

Golder Associates Ltd.

Thermocouple Attachment Units

- Mirion Technologies

Thermocouples

- Acromag, Inc.
- Delta M Corporation
- Mirion Technologies
- Temp-Pro Inc.

Thermocouples: In-Core

- AZZ / NLI
- Mirion Technologies
- Nutherm International, Inc.

Thermocouples: In-Core, Replacement

- Mirion Technologies

Thermocouples: Safety-Related

- AZZ / NLI
- Mirion Technologies
- Nutherm International, Inc.
- Temp-Pro Inc.
- Wyle Laboratories, Inc.

Tool Kits

BURNDY

Tooling: Underwater

Underwater Construction Corporation

Tools: Control Rod Drive Handling

- Scientech, a business unit of Curtiss-Wright Flow Control Company

Tools: Electrical

- BURNDY
- Rolls-Royce

Tools: Fabrication

- Kinectrics Incorporated
- Precision Custom Components, LLC
- Rolls-Royce

Tools: Fuel Pool

- Energy Steel & Supply CO.

Tools: Hydraulic

Hydratight

Tools: Inspection

- Candu Energy Inc
- GE Hitachi Nuclear Energy
- Kinectrics Incorporated
- Rolls-Royce

Tools: LPRM Handling

- Scientech, a business unit of Curtiss-Wright Flow Control Company

Tools: Maintenance

- Candu Energy Inc

Tools: Radiation Handling

- Rolls-Royce

Tools: Remote Handling

- Candu Energy Inc
- Diakont
- Rolls-Royce
- WMG, Inc.

Tools: Robotic

- Diakont
- GE Hitachi Nuclear Energy
- iRobot Corporation
- Rolls-Royce

Tools: Telerobotic

- Rolls-Royce

Tracer Gas Testing

- NUCON International, Inc.

got radiation?

Imaging in radiation environments just got easier with our MegaRAD line of radiation hardened cameras. With superior capabilities for operating in radiation environments, they provide excellent image quality well beyond dose limitations of conventional cameras. MegaRAD cameras provide excellent signal-to-noise and sensitivity with wide spectral response, making the MegaRAD series of cameras well suited for radiation hardened imaging applications

see what you've been missing

• Learn more at thermoscientific.com/cidtec



MegaRAD3 cameras produce color or monochrome video up to 3×10^6 rads total dose



MegaRAD1 cameras produce monochrome video up to 1×10^6 rads total dose



Intensified cameras for high speed gated events and low light imaging





Structural Integrity Associates, Inc.®

GREAT THINGS
COME FROM
Hard Work



J. Robert Oppenheimer
Theoretical physicist often called the "father of the atomic bomb" for his role in the Manhattan Project, the World War II project that developed the first nuclear weapons. 1904 - 1967

Our engineers and NDE technicians are no strangers to hard work. It's part of our core values at Structural Integrity. We're someone you can trust to provide innovative, top quality, high value solutions on every project related to plant integrity issues, including support of:

- BWR and PWR internals evaluation
- License Renewal applications and commitments
- Non-destructive examinations
- Degraded component assessments
- Buried piping programs, inspection, and remediation
- And much more

Call Structural Integrity
877-4SI-POWER
www.structint.com/npi



Scan the QR Code for more information

Training Aids

- Rolls-Royce

Training Support

- Argonne National Laboratory
- BHI Energy
- HukariAscendent
- Rolls-Royce
- Sargent & Lundy

Training: ANSI/ASME N510

- Jacox Associates
- NUCON International, Inc.
- Rolls-Royce

Training: ASME Code

- Rolls-Royce
- Structural Integrity Associates, Inc.

Training: CFAR

- Rolls-Royce

Training: Chemistry

- Sciencetech, a business unit of Curtiss-Wright Flow Control Company

Training: Codes

- Rolls-Royce

Training: Computer-Based

- The Macris Group

Training: Computer-Based, Health Physics

- Mirion Technologies

Training: Corrosion

- Structural Integrity Associates, Inc.

Training: Diesel Generators

- Rolls-Royce

Training: Dosimetry

- Mirion Technologies

Training: Employee

- BHI Energy

Training: Employee Concerns Programs

- Conger & Elsea, Inc.

Training: Engineering

- American Crane & Equipment Corp.
- DCS Systems Inc.
- Fauske & Associates., LLC

Training: Failure Analysis

- Conger & Elsea, Inc.
- Rolls-Royce
- Southwest Research Institute
- Structural Integrity Associates, Inc.

Training: Field

- Schulz Electric Company

Training: Health Physics

- Pacific Radiation Corporation

Training: Human Factors

- Rolls-Royce

Training: Human Performance Improvement

- Conger & Elsea, Inc.
- Human and Organizational Performance Improvement

Training: Incident Investigation

- Conger & Elsea, Inc.

Training: Inspection

- Conger & Elsea, Inc.
- Schulz Electric Company

Training: Instructor

- G.D. Barri & Associates, Inc.

Training: Job Analysis

- G.D. Barri & Associates, Inc.

Training: Maintenance

- G.D. Barri & Associates, Inc.
- Schulz Electric Company

Training: Management's Role in Safe Operation

- Human and Organizational Performance Improvement

Training: Nondestructive Testing

- EST Group, a business unit of Curtiss-Wright Flow Control Company

Training: Nuclear Equipment Maintenance

- AZZ / NLI
- Rolls-Royce
- Schulz Electric Company
- Ultimate Power Solutions

Training: Nuclear Fuel

- DCS Systems Inc.

Training: Nuclear Safety

- CTR Technical Services, Inc.
- HukariAscendent
- VGSSolutions

Training: Nuclear Simulator

- Sciencetech, a business unit of Curtiss-Wright Flow Control Company
- Tecnomat, S.A.

Training: Operational Readiness

- Conger & Elsea, Inc.
- HukariAscendent

Training: Operations Personnel

- G.D. Barri & Associates, Inc.
- Sciencetech, a business unit of Curtiss-Wright Flow Control Company

Training: Presentation Methods

- Conger & Elsea, Inc.

Training: Probabilistic Safety Analysis

- Diakont

Training: Procedure Writing

- G.D. Barri & Associates, Inc.
- HukariAscendent

Training: Procurement

- HukariAscendent

Training: Program Development Services

- HukariAscendent
- The Delphi Groupe, Inc.

Training: Project Management

- HukariAscendent
- Rolls-Royce

Training: Quality Assurance

- DCS Systems Inc.
- Howard L. Sobel, P.E.
- HukariAscendent
- Rolls-Royce
- Sargent & Lundy
- Theseus Professional Services, LLC

Training: Quality Auditor

- Conger & Elsea, Inc.
- DCS Systems Inc.
- HukariAscendent
- Rolls-Royce

Training: Quality Control

- Rolls-Royce

Training: Quality Function Deployment

- Rolls-Royce

Training: Quality Improvement

- HukariAscendent
- Rolls-Royce
- Sargent & Lundy

Training: Quality Leadership Skills

- Rolls-Royce

Training: Radiation Monitoring Systems

- Mirion Technologies

Training: Radiation Protection

- Bevelacqua Resources
- BHI Energy
- Pacific Radiation Corporation

Training: Radiation Safety

- DADE Moeller & Associated, Inc.
- Pacific Radiation Corporation

Training: Radioactive Materials Handling

- WMG, Inc.

Training: Results Engineering

Power & Energy Systems Services

Training: Risk Analysis

Conger & Elsea, Inc.
• Rolls-Royce

Training: Risk Assessment

Conger & Elsea, Inc.
• Rolls-Royce

Training: Risk Tree

Conger & Elsea, Inc.

Training: Root Cause Analysis

Conger & Elsea, Inc.
DCS Systems Inc.
• Rolls-Royce
• Structural Integrity Associates, Inc.

Training: Safety Evaluations

Conger & Elsea, Inc.
• Scientech, a business unit of Curtiss-Wright
Flow Control Company
VGSolutions

Training: Security

Argonne National Laboratory, Vulnerability
Assessment Team

Training: SPC Chart Interpretation

• Rolls-Royce

Training: Standards

• Rolls-Royce

Training: Task Analysis

• Rolls-Royce

Training: Team Leaders

Conger & Elsea, Inc.
• Rolls-Royce
The Macris Group

Training: Technical Staff

Atlantic Nuclear Services Inc.
DCS Systems Inc.
• G.D. Barri & Associates, Inc.
• Rolls-Royce
Sargent & Lundy

Training: Total Quality

• Rolls-Royce

Training: Vacuum Technology

• Rolls-Royce

Training: Valves & Valve Actuators

BHI Energy
• Rolls-Royce
Valcor Engineering Corporation

Training: Waste Management

Argonne National Laboratory
• Rolls-Royce
WMG, Inc.

Training: Welding

• Rolls-Royce

Transducers

C.J. Enterprises
Enertech, a business unit of Curtiss-Wright
Flow Control Company

Transducers: Displacement

C.J. Enterprises

Transducers: In-Line, High-Temperature

• Mirion Technologies

Transducers: In-Line, Low-Temperature

• Mirion Technologies

Transducers: Load

C.J. Enterprises

Transducers: Pressure

• AZZ / NLI
C.J. Enterprises

Transducers: Safety-Related

• AZZ / NLI
Nutherm International, Inc.
Wyle Laboratories, Inc.

Transducers: Torque

WITTENSTEIN

Transducers: Ultrasonic

Technisonic Research Inc.

Transfer Switches: 1E

• AZZ / NLI
Nutherm International, Inc.
Wyle Laboratories, Inc.

Transformer Replacement Services

Hake Rigging Company

Transformers: Safety-Related

• AZZ / NLI
Nutherm International, Inc.
Wyle Laboratories, Inc.

Transmitters: Radiation Monitors

• Mirion Technologies

Transmitters: Diff. Press., Safety-Related

DRS Consolidated Controls, Inc
Nutherm International, Inc.
Weed Instrument Co., Inc d/b/a Ultra Elec-
tronics, NSPI
Wyle Laboratories, Inc.

Transmitters: Level

• AZZ / NLI
Enertech, a business unit of Curtiss-Wright
Flow Control Company

Transmitters: Personnel Dosimetry

• Mirion Technologies

Transmitters: Pressure

• AZZ / NLI
Weed Instrument Co., Inc d/b/a Ultra Elec-
tronics, NSPI

Transmitters: Safety-Related

• AZZ / NLI
DRS Consolidated Controls, Inc
Nutherm International, Inc.
Wyle Laboratories, Inc.

Transmitters: Temperature

• AZZ / NLI
Weed Instrument Co., Inc d/b/a Ultra Elec-
tronics, NSPI

Transport: Heavy

Barnhart
Hake Rigging Company

Trash Rakes & Racks

• Oregon Iron Works, Inc

Traveling Water Screens

• Energy Steel & Supply CO.
• Oregon Iron Works, Inc

Trending: Electric Machinery

• Schulz Electric Company

Tritium Technologies

• Rolls-Royce

Tube Bundle Components

• Energy Steel & Supply CO.

Tube Clamps

James C. White Company

Tube Expansion

• Energy Steel & Supply CO.

Tube Fittings

• Energy Steel & Supply CO.
• TW Metals - Nuclear Materials Solutions

Tube Heating Products

• Energy Steel & Supply CO.

Tube Plug Qualification

• Energy Steel & Supply CO.
• EST Group, a business unit of Curtiss-Wright
Flow Control Company

Tube Plug Removal

Conco Systems, Inc.
• Energy Steel & Supply CO.
• EST Group, a business unit of Curtiss-Wright
Flow Control Company

Tube Plugging

Conco Systems, Inc.
• Energy Steel & Supply CO.
• EST Group, a business unit of Curtiss-Wright
Flow Control Company
Powerfect

Tube Stakes: Anti-Vibration

• EST Group, a business unit of Curtiss-Wright
Flow Control Company

Tube: Copper

• Energy Steel & Supply CO.
• TW Metals - Nuclear Materials Solutions

Tube: Copper Alloy

Tioga Pipe Supply Company Inc.
• TW Metals - Nuclear Materials Solutions

Tubing

• Chatham Steel Corporation
• Energy Steel & Supply CO.
• Frham Safety Products, Inc.
Newage Industries, Inc.
Plymouth Tube Company, Stainless Steel
Tubing
• Seal Master Corporation
Tioga Pipe Supply Company Inc.
• TW Metals - Nuclear Materials Solutions
Veridium

Tubing: Alloy

• Chatham Steel Corporation
• Energy Steel & Supply CO.
Plymouth Tube Company, Stainless Steel
Tubing
• TW Metals - Nuclear Materials Solutions

Tubing: Aluminum

• TW Metals - Nuclear Materials Solutions

Historical NPJ Cover



*November-December 1992
Volume 10, Issue 7*

Tubing: Calandria

- Cameco Fuel Manufacturing Inc.
- TW Metals - Nuclear Materials Solutions
- Veridiam

Tubing: Carbon Steel

- Chatham Steel Corporation
- Energy Steel & Supply CO.
- Plymouth Tube Company, Stainless Steel Tubing
- Tioga Pipe Supply Company Inc.
- TW Metals - Nuclear Materials Solutions

Tubing: Corrosion-Resistant

- Chatham Steel Corporation
- Energy Steel & Supply CO.
- Tioga Pipe Supply Company Inc.
- TW Metals - Nuclear Materials Solutions

Tubing: Metal

- Chatham Steel Corporation
- Energy Steel & Supply CO.
- TW Metals - Nuclear Materials Solutions

Tubing: Plastic

- International Plastics, Inc.
- LANCS Industries Holdings, LLC.
- Newage Industries, Inc.
- Reef Industries, Inc.

Tubing: Pressure

- Energy Steel & Supply CO.
- TW Metals - Nuclear Materials Solutions

Tubing: Stainless Steel

- Chatham Steel Corporation
- Energy Steel & Supply CO.
- Joseph Oat Corporation
- Plymouth Tube Company, Stainless Steel Tubing
- Thermal Engineering International (USA)
- Tioga Pipe Supply Company Inc.
- TW Metals - Nuclear Materials Solutions
- Veridiam

Tubing: Titanium

- Cameco Fuel Manufacturing Inc.
- Energy Steel & Supply CO.
- Plymouth Tube Company, Stainless Steel Tubing
- Tioga Pipe Supply Company Inc.
- TW Metals - Nuclear Materials Solutions
- Veridiam

Tubing: Zirconium

- Cameco Fuel Manufacturing Inc.
- TW Metals - Nuclear Materials Solutions

Turbine Blades: Coating Services

- Fuel Tank Maintenance Company LLC

Turbine Blades: Weld Repairs

- Stork H&E Turbo Blading

Turbine Boresonic Examination

- Rolls-Royce

Turbine Generator Inspection

- BHI Energy
- Structural Integrity Associates, Inc.

Turbine Generator Maintenance

- BHI Energy
- Energy Resources Group, Inc.

Turbine Generators

- Rolls-Royce
- Western United Industries

Turbine Inspection

- BHI Energy
- Rolls-Royce
- Stork H&E Turbo Blading

Turbine Maintenance

- Aquilex WSI Nuclear Services
- Stork H&E Turbo Blading

Turbine Outage Management

- BHI Energy

Turbines: Steam

- BHI Energy
- Stork H&E Turbo Blading
- The Shaw Group
- Western United Industries

UltraFiltration

- Diversified Technologies Services, Inc.
- Fuel Tank Maintenance Company LLC

Ultrasonic Inspection

- Candu Energy Inc
- Structural Integrity Associates, Inc.

Ultrasonic Inspection System Development

- Diakont
- Kinectrics Incorporated

Ultrasonic Level Monitoring System Service

- AZZ / NLI

Ultrasonic Testing Services

- EST Group, a business unit of Curtiss-Wright
- Flow Control Company
- Structural Integrity Associates, Inc.

Uninterruptible Power Supplies

- Energys
- GUTOR Electronic LLC

Uninterruptible Power Supplies: Service

- Energys
- Ultimate Power Solutions

Uninterruptible Power Supply: Safety-Related

- AMETEK Programmable Power, Supporting Elgar Nuclear Equip.
- AZZ / NLI
- GUTOR Electronic LLC
- Nutherm International, Inc.
- Wyle Laboratories, Inc.

Vacuum Chambers

- Oregon Iron Works, Inc
- Precision Custom Components, LLC

Vacuum Equipment

- Blue Lake Products
- Frham Safety Products, Inc.
- VAT, INC.

Vacuum Replacement Breakers: Medium-Voltage, Safety-Related

- Nutherm International, Inc.

Vacuum Systems

- American Crane & Equipment Corp.
- Rolls-Royce
- Tri Nuclear Corporation
- VAT, INC.

Vacuums: Underwater

- Diversified Technologies Services, Inc.
- Tri Nuclear Corporation

Vacuums: HEPA-Filtered

- Blue Lake Products
- Frham Safety Products, Inc.
- Pentek, Inc.
- Rolls-Royce
- UniTech Services Group, Inc., Div. of Unifirst Corp.

Valve Actuator

- AZZ / NLI
- BHI Energy
- Copes-Vulcan,SPX Brand
- Enertech, a business unit of Curtiss-Wright
- Flow Control Company
- Flowserve Flow Control Division
- Valcor Engineering Corporation
- WITTENSTEIN

Valve Actuator Parts

- AZZ / NLI
- Enertech, a business unit of Curtiss-Wright
- Flow Control Company
- Flowserve Flow Control Division

Valve Actuator Repair

- Enertech, a business unit of Curtiss-Wright
- Flow Control Company
- Flowserve Flow Control Division

Valve Actuators: Electric

- AZZ / NLI
- Enertech, a business unit of Curtiss-Wright
- Flow Control Company
- Flowserve Flow Control Division
- Schulz Electric Company
- SSM Industries, Inc.
- Valcor Engineering Corporation

Valve Actuators: Electrohydraulic

- Enertech, a business unit of Curtiss-Wright
- Flow Control Company
- SSM Industries, Inc.

Valve Actuators: Electromechanical

- AZZ / NLI
- Enertech, a business unit of Curtiss-Wright
- Flow Control Company
- SSM Industries, Inc.

Valve Actuators: Hydraulic

- Enertech, a business unit of Curtiss-Wright
- Flow Control Company
- Flowserve Flow Control Division

Valve Actuators: Mechanical

- Seal Master Corporation

Valve Actuators: Pneumatic

- AZZ / NLI
- Copes-Vulcan,SPX Brand
- Enertech, a business unit of Curtiss-Wright
- Flow Control Company
- Seal Master Corporation
- SSM Industries, Inc.

Valve Analysis

- BHI Energy
- Copes-Vulcan,SPX Brand

Valve Assemblies

- AZZ / NLI
- Copes-Vulcan,SPX Brand
- Enertech, a business unit of Curtiss-Wright
- Flow Control Company
- Valcor Engineering Corporation

Valve Diagnostic Systems

- Enertech, a business unit of Curtiss-Wright
- Flow Control Company
- Valcor Engineering Corporation

Valve Flow Monitoring Systems

- Technology for Energy Corporation (TEC)

Valve Modification

- BHI Energy
- Copes-Vulcan,SPX Brand
- Enertech, a business unit of Curtiss-Wright
- Flow Control Company

Valve Parts

- AZZ / NLI
- Copes-Vulcan,SPX Brand
- Energy Steel & Supply CO.
- Enertech, a business unit of Curtiss-Wright
- Flow Control Company
- Flowserve Flow Control Division
- Trust Manufacturing

Valve Positioners

- AZZ / NLI
- Copes-Vulcan,SPX Brand
- Emerson Process Management
- Enertech, a business unit of Curtiss-Wright
- Flow Control Company
- Nutherm International, Inc.

Valve Reconditioning

- Copes-Vulcan,SPX Brand
- Energy Steel & Supply CO.
- Enertech, a business unit of Curtiss-Wright
- Flow Control Company

Global Expertise

Cameco Fuel Manufacturing (CFM) is a leading supplier of Fuel Assemblies and Reactor Components for the nuclear industry. Our rigorous commitment to high quality standards combined with more than 50 years of experience and unique capabilities makes Cameco Fuel Manufacturing the *Supplier of Choice* in the global nuclear industry.

Zr
Zirconium



Cameco Fuel Manufacturing Inc.
Zirconium, Tubing & Reactor Components
200 Dorset Street East, Port Hope
Ontario, Canada L1A 3V4

For more information please contact:

Doug Burton, P.Eng
doug_burton@cameco.com

Celeste Pendlebury, Manager Marketing
celeste_pendlebury@cameco.com



Cameco

Cameco Fuel Manufacturing Inc.

Zirconium, Tubing & Reactor Components

www.cameco.com

Valve Refurbishment

- Copes-Vulcan,SPX Brand
- Energy Steel & Supply CO.
- Enertech, a business unit of Curtiss-Wright Flow Control Company
- Henry Pratt Company

Valve Repair

- Aquilex WSI Nuclear Services
- BHI Energy
- Copes-Vulcan,SPX Brand
- Emerson Process Management
- Enertech, a business unit of Curtiss-Wright Flow Control Company
- Flowserve Flow Control Division

Valve Service Supervision

- Enertech, a business unit of Curtiss-Wright Flow Control Company

Valve Services

- BHI Energy
- Copes-Vulcan,SPX Brand
- Enertech, a business unit of Curtiss-Wright Flow Control Company
- Flowserve Flow Control Division

Valve Testing

- BHI Energy
- Wyle Laboratories, Inc.

Valves

- AZZ / NLI
- Black & Veatch
- Copes-Vulcan,SPX Brand
- Energy Steel & Supply CO.
- Enertech, a business unit of Curtiss-Wright Flow Control Company
- Flowserve Flow Control Division
- The Shaw Group
- Valcor Engineering Corporation
- VAT, INC.
- Velan Inc.

Valves: Air Operated Globe

- AZZ / NLI
- BHI Energy
- Conval Inc.
- Enertech, a business unit of Curtiss-Wright Flow Control Company
- Flowserve Flow Control Division
- Valcor Engineering Corporation

Valves: Ball

- AZZ / NLI
- Copes-Vulcan,SPX Brand
- Enertech, a business unit of Curtiss-Wright Flow Control Company
- Flowserve Flow Control Division
- Henry Pratt Company
- Velan Inc.

Valves: Bellows Sealed

- Conval Inc.
- Enertech, a business unit of Curtiss-Wright Flow Control Company
- Flowserve Flow Control Division
- Seal Master Corporation
- Valcor Engineering Corporation
- VAT, INC.
- Velan Inc.

Valves: Butterfly

- AZZ / NLI
- Copes-Vulcan,SPX Brand
- Energy Steel & Supply CO.
- Enertech, a business unit of Curtiss-Wright Flow Control Company
- Flowserve Flow Control Division
- Henry Pratt Company
- VAT, INC.
- Velan Inc.

Valves: Check

- AZZ / NLI
- BHI Energy
- Copes-Vulcan,SPX Brand
- Energy Steel & Supply CO.

- Enertech, a business unit of Curtiss-Wright Flow Control Company
- Flowserve Flow Control Division
- Henry Pratt Company
- Rolls-Royce
- Valcor Engineering Corporation
- Velan Inc.

Valves: Control

- BHI Energy
- Copes-Vulcan,SPX Brand
- Emerson Process Management
- Enertech, a business unit of Curtiss-Wright Flow Control Company
- Flowserve Flow Control Division
- HI-Q Environmental Products Company
- Rolls-Royce

Valves: Custom

- AZZ / NLI
- Copes-Vulcan,SPX Brand
- Enertech, a business unit of Curtiss-Wright Flow Control Company
- Precision Custom Components, LLC
- Rolls-Royce
- Seal Master Corporation
- Valcor Engineering Corporation

Valves: Diaphragm

- AZZ / NLI
- Copes-Vulcan,SPX Brand
- Enertech, a business unit of Curtiss-Wright Flow Control Company
- Seal Master Corporation
- Valcor Engineering Corporation
- VAT, INC.

Valves: Diverter

- Valcor Engineering Corporation

Valves: Emergency Service

- Mirion Technologies

Valves: Explosive Actuated

- Copes-Vulcan,SPX Brand
- Mirion Technologies

Valves: Flanged

- Copes-Vulcan,SPX Brand
- Energy Steel & Supply CO.
- Enertech, a business unit of Curtiss-Wright Flow Control Company

Valves: Gate

- AZZ / NLI
- Conval Inc.
- Copes-Vulcan,SPX Brand
- Energy Steel & Supply CO.
- Enertech, a business unit of Curtiss-Wright Flow Control Company
- Flowserve Flow Control Division
- Valcor Engineering Corporation
- VAT, INC.
- Velan Inc.

Valves: Globe

- AZZ / NLI
- Conval Inc.
- Copes-Vulcan,SPX Brand
- Enertech, a business unit of Curtiss-Wright Flow Control Company
- Flowserve Flow Control Division
- Valcor Engineering Corporation
- Velan Inc.

Valves: High-Pressure

- AZZ / NLI
- Conval Inc.
- Copes-Vulcan,SPX Brand
- Enertech, a business unit of Curtiss-Wright Flow Control Company
- Flowserve Flow Control Division
- Valcor Engineering Corporation
- VAT, INC.

Valves: Isolation

- AZZ / NLI
- Copes-Vulcan,SPX Brand

- Enertech, a business unit of Curtiss-Wright Flow Control Company
- Flowserve Flow Control Division
- Valcor Engineering Corporation
- VAT, INC.

Valves: Knife Gate

- Energy Steel & Supply CO.

Valves: Main Steam Isolation, Maintenance

- Aquilex WSI Nuclear Services
- BHI Energy
- Energy Steel & Supply CO.
- Enertech, a business unit of Curtiss-Wright Flow Control Company
- Flowserve Flow Control Division

Valves: Metering

- Valcor Engineering Corporation

Valves: Motor Operated

- AZZ / NLI
- BHI Energy
- Copes-Vulcan,SPX Brand
- Enertech, a business unit of Curtiss-Wright Flow Control Company
- Flowserve Flow Control Division
- Schulz Electric Company

Valves: Needle

- HI-Q Environmental Products Company
- Trust Manufacturing
- Valcor Engineering Corporation

Valves: Packless

- Valcor Engineering Corporation

Valves: Pilot

- Valcor Engineering Corporation

Valves: Plug

- Copes-Vulcan,SPX Brand
- Henry Pratt Company

Valves: Pressure Relief

- Energy Steel & Supply CO.
- Enertech, a business unit of Curtiss-Wright Flow Control Company
- Rolls-Royce

Valves: Relief

- Enertech, a business unit of Curtiss-Wright Flow Control Company
- Rolls-Royce

Valves: Safety Relief, Maintenance

- G.D. Barri & Associates, Inc.
- Rolls-Royce

Valves: Safety-Related

- AZZ / NLI
- Copes-Vulcan,SPX Brand
- Enertech, a business unit of Curtiss-Wright Flow Control Company
- Flowserve Flow Control Division
- Mirion Technologies
- Rolls-Royce
- Schulz Electric Company
- Sciencetech, a business unit of Curtiss-Wright Flow Control Company
- Valcor Engineering Corporation

Valves: Sampling

- Copes-Vulcan,SPX Brand
- Valcor Engineering Corporation

Valves: Solenoid

- Enertech, a business unit of Curtiss-Wright Flow Control Company
- Valcor Engineering Corporation

Valves: Steam Conditioning

- Copes-Vulcan,SPX Brand
- Emerson Process Management

Valves: Vacuum

- VAT, INC.

Variable Frequency Drives

- SSM Industries, Inc.

Vehicles: Cask Transport

- Oregon Iron Works, Inc
- Rolls-Royce

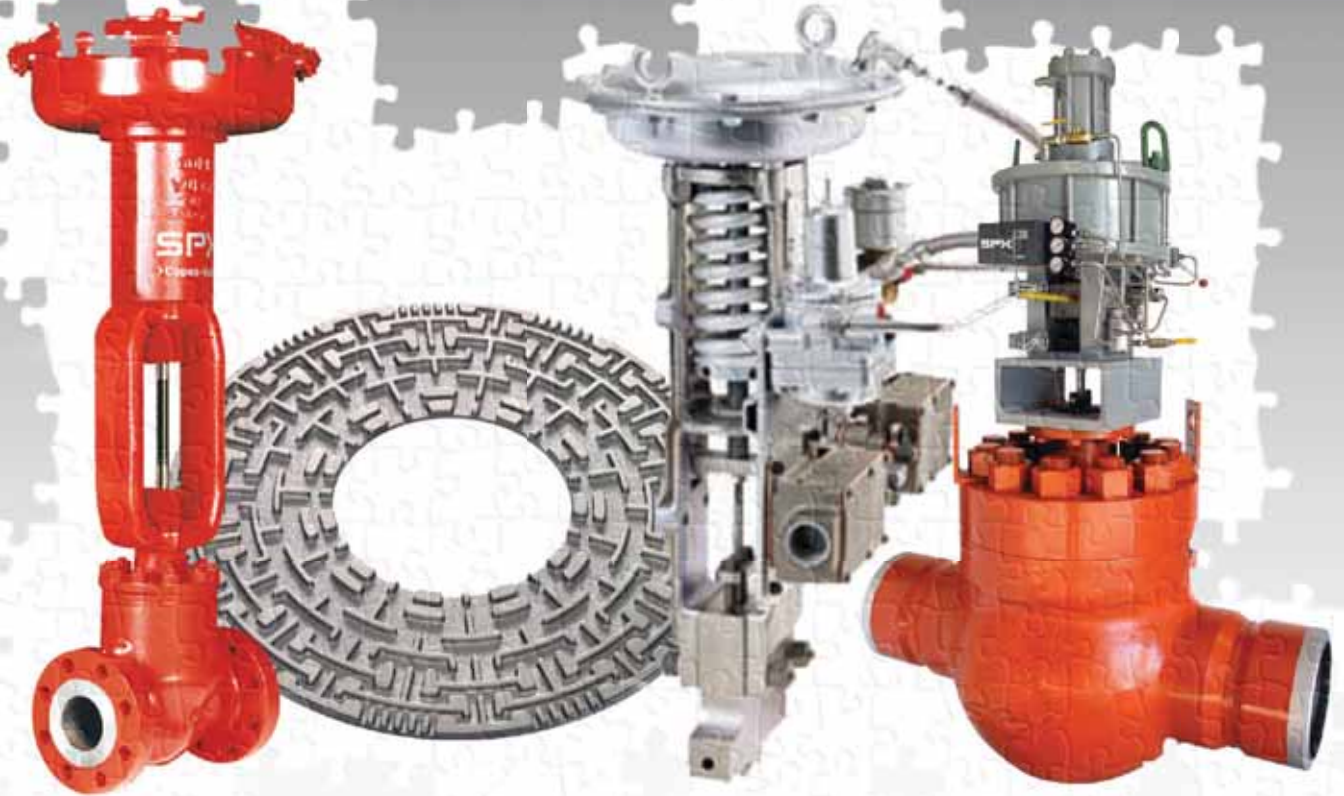

WHERE VALVE SOLUTIONS COME TOGETHER FOR THE NUCLEAR INDUSTRY

SPX is finding innovative ways to help the world meet its ever growing demand for power by providing a broad range of high-quality, custom-engineered systems and components for the power, process, and nuclear industries.

Copes-Vulcan, an SPX brand, has been engineering and manufacturing valves for the nuclear industry for over forty years, and is an unsurpassed innovator in control, isolation and rotary valves. SPX's extensive line of valve types, actuation, trims, and engineering expertise allows us to provide you with the best fluid handling solutions. Contact SPX to find a complete range of engineered solutions for your specific power generation application.

To learn more visit www.spx.com

> Copes-Vulcan[®]

Vehicles: Intelligent

- Rolls-Royce

Vehicles: Remotely-Operated

- Diakont
- Rolls-Royce

Vessel Fabrication

- AZZ / NLI
- Energy Steel & Supply CO. Greenberry Fabrication
- Joseph Oat Corporation
- Oregon Iron Works, Inc
- Penn Iron Works, Inc. Precision Custom Components, LLC
- Rolls-Royce

Vesselets

- Energy Steel & Supply CO.

Video Inspection Services

- Powerfect
- Rolls-Royce

Video Inspection Systems

- Diakont
- Mirion Technologies
- Thermo Scientific-CIDTEC, (Part of Thermo Fisher Scientific)

Viewing Systems: Through-Wall

- Mirion Technologies

Voltage Regulators: Safety-Related

- Nutherm International, Inc.
- Wyle Laboratories, Inc.

Washers: Spherical

- Energy Steel & Supply CO.
- Trust Manufacturing

Waste Characterization

- Eberline Services Inc.
- Rolls-Royce

Waste Encapsulation

- Ceradyne Boron Products
- Diversified Technologies Services, Inc. KURION, INC
- NSSI/Recovery Services Inc.
- Rolls-Royce

Waste Management Services

- AREVA Inc.
- Candu Energy Inc KURION, INC
- Rolls-Royce
- S.M. Stoller Corp. Studsvik, Inc

Waste Processing

- Babcock Noell KURION, INC
- Rolls-Royce
- Studsvik, Inc
- WMG, Inc.

Waste Retrieval

- Rolls-Royce

Waste Solidification

- Ceradyne Boron Products
- Diversified Technologies Services, Inc.
- Rolls-Royce

Waste Solidification Chemicals

- Rolls-Royce

Waste Solidification Equipment

- BHI Energy
- Rolls-Royce

Waste Storage

- Biodex Medical Systems, Inc.
- Dufrane Nuclear Shielding, Inc.
- NSSI/Recovery Services Inc.
- Rolls-Royce

Waste: Liquid, Concentrators

- Rolls-Royce
- Studsvik, Inc

Waste: Mercury

- NUCON International, Inc.

Waste: Mixed, Analysis

- Sargent & Lundy

Waste: Mixed, Management

- Eberline Services Inc.
- KURION, INC
- NSSI/Recovery Services Inc.

Water Chemistry Equipment (BWR)

- Chemetrics, Inc.
- GE Hitachi Nuclear Energy

Water Filtration Equipment

- Rolls-Royce
- Tri Nuclear Corporation

Water Filtration Units

- Rolls-Royce

Water Management

- Pawling Engineered Products
- The Shaw Group

Water Testing Equipment

- Chemetrics, Inc.

Water Treatment Services

- The Shaw Group

Water Treatment: Waste

- KURION, INC
- Studsvik, Inc

Waterblasting/Hydrolasing Services

- Fuel Tank Maintenance Company LLC

Weld Repair

- Aquilex WSI Nuclear Services
- BHI Energy
- Black & Veatch
- Energy Steel & Supply CO.
- Joseph Oat Corporation
- Rolls-Royce
- Structural Integrity Associates, Inc.

Welding

- American Crane & Equipment Corp.
- BHI Energy
- Black & Veatch
- Energy Steel & Supply CO.
- Fuel Tank Maintenance Company LLC
- GE Hitachi Nuclear Energy
- Joseph Oat Corporation
- Oregon Iron Works, Inc
- Penn Iron Works, Inc. Precision Custom Components, LLC
- Rolls-Royce
- Westerman Nuclear

Welding Developments

- Aquilex WSI Nuclear Services
- Energy Steel & Supply CO.
- Precision Custom Components, LLC
- Rolls-Royce

Welding Equipment

- Energy Steel & Supply CO.
- Tri Tool Inc.

Welding Equipment: Special Design

- Aquilex WSI Nuclear Services

Welding Materials

- AZZ / NLI
- Energy Steel & Supply CO.
- nexArc Inc.
- TW Metals - Nuclear Materials Solutions
- Weldstar

Welding: ASME Code

- AT&F Nuclear, Inc, Division of AT & F
- BHI Energy
- Black & Veatch
- Ellis & Watts Global Industries, LLC.
- Energy Steel & Supply CO.
- Joseph Oat Corporation
- Oregon Iron Works, Inc
- Penn Iron Works, Inc. Precision Custom Components, LLC
- Rolls-Royce
- Weldstar
- Westerman Nuclear

Welding: Automated

- BHI Energy
- Oregon Iron Works, Inc
- Precision Custom Components, LLC
- Westerman Nuclear

Welding: BWR Remote

- BHI Energy

Welding: Cobalt Free Materials

- BHI Energy

Welding: Hardfacing

- BHI Energy
- Energy Steel & Supply CO.
- Precision Custom Components, LLC

WELDSTAR IS YOUR EXPERIENCED AND RELIABLE SOURCE FOR NUCLEAR TESTED FILLER MATERIAL



Supplying Customers Worldwide
An ASME Certificate Holder Since 1976

- NUPIC and NIAC Audited
- QSC-229 Certificate
- Quality program compliance with 10CFR50 Appendix B and NQA-1
- Broad inventory of welding & brazing materials
- Inventory is tested to ASME Section II, Part C, and ASME Section III, Subsection NB for Class 1 components
- No minimum orders or test charges for inventoried filler metals
- Ship stock items within 24-48 hours
- Active members of AWS and ASME

Contact our dedicated Nuclear team:
1750 Mitchell Road • Aurora, IL 60505
(P) 630-859-3100 • (F) 630-859-3199
(Email) info@weldstar.com
(Website) www.weldstar.com



OLD VALUES...NEW IDEAS

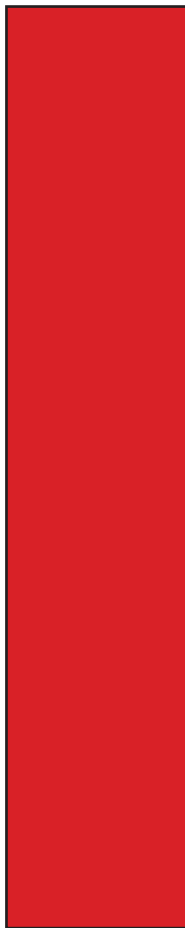

Welding: Narrow Groove, Automatic

- BHI Energy
- Energy Steel & Supply CO.
- Precision Custom Components, LLC

Welding: Overlay, Automatic

- Aquilex WSI Nuclear Services
- BHI Energy
- Energy Steel & Supply CO.
- Precision Custom Components, LLC
- Rolls-Royce

Welding: Pipe & Pipe Fitting

- BHI Energy
- Energy Steel & Supply CO.
- Greenberry Fabrication
- Rolls-Royce
- Trust Manufacturing

Welding: Remote

- Aquilex WSI Nuclear Services
- BHI Energy
- Precision Custom Components, LLC

Welding: Shell Girth

- Energy Steel & Supply CO.
- Oregon Iron Works, Inc
- Precision Custom Components, LLC

Welding: Special

- Aquilex WSI Nuclear Services
- BHI Energy
- Energy Steel & Supply CO.
- Oregon Iron Works, Inc
- Precision Custom Components, LLC
- Rolls-Royce

Welding: Underwater Wet

- Underwater Construction Corporation

Welding: Valve

- BHI Energy
- Energy Steel & Supply CO.

Windows: Clear Lead Viewing

- Biodex Medical Systems, Inc.
- Dufrane Nuclear Shielding, Inc.

Wipes: Decontamination

- Biodex Medical Systems, Inc.
- Frham Safety Products, Inc.
- UniTech Services Group, Inc., Div. of Unifirst Corp.

Wiping Cloths

- Frham Safety Products, Inc.

Wire Cloth

- Energy Steel & Supply CO.
- McNichols Company

Wire: Consumable

- nexArc Inc.
- Weldstar

Wire: Nickel Alloy

- nexArc Inc.

Wire: Safety-Related

- AZZ / NLI
- Nutherm International, Inc.
- Rockbestos-Surprenant Cable Corporation
- Weldstar

Wire: Stainless

- nexArc Inc.

Wood, fire retardant treated

- Lonza Wood Protection

Writing: Procedure

- BHI Energy
- Rolls-Royce

Writing: Technical

- Rolls-Royce

X-Ray Diffraction Equipment

- Technology for Energy Corporation (TEC)

X-Ray Equipment

- Gammasonics Institute for Medical Research

X-Ray Inspection Systems: Security

- Gammasonics Institute for Medical Research
- Spectra Physics, Hilger Crystals Limited

X-Ray: Shielding

- Dufrane Nuclear Shielding, Inc.
- MarShield, Div. of Mars Metal Company

Zirconium

- Joseph Oat Corporation
- Rolls-Royce

*TEC...your partner on
the road to smooth
plant operation*



Working with a proven company can give you the confidence to operate your plant more efficiently and avoid unexpected and costly downtime.

You can depend on TEC to make your work go more smoothly.

safety relief valve monitoring (active and passive)

signal isolation

loose part monitoring and impact trending

materials testing products and services

TEC

providing superior measurement and analysis products and services

10737 Lexington Drive, Knoxville, TN 37932

865/966-5856 or Fax 865/675-1241

www.tec-usa.com

TEC's QA program meets the requirements of 10CFR Part 50, Appendix B, and 10CFR Part 21.

Corporate Capabilities

• Denotes advertiser

• **Aerofin,**

4621 Murray Pl., Lynchburg, VA 24502;
Phone: (434) 845-7081, Fax: (434) 528-6281,
Http://www.aerofin.com, Email: bellioth@
aerofin.com, Contact: Brian Elliott.
(See advertisement on page 45)

Coils: Cooling
Coils: Heating
Coolers: Containment
Coolers: Drywell
Heat Exchangers
Heat Exchangers
Heat Exchangers: Rebuilding
Heat Exchangers: Shell
Pumps
Pumps: Centrifugal
Pumps: Circulating
Strainers: Self-Cleaning
Tanks: Pressure

• **American Crane & Equipment Corp.,**

531 Old Swede Rd., Douglassville, PA 19518;
Phone: (610) 385-6061ext 224, Fax: (610) 385-
3191, Http://www.americancrane.com, Email:
sales@americancrane.com, Contact: Karen
Norheim.
(See advertisement on page 29)

Analysis: Engineering
Analysis: Structural
Casks: Transport
Clamps: Chain
Component Handling
Consulting: Engineering
Consulting: Engineering Mechanics
Consulting: Seismic
Consulting: Structural
Containers: Transport
Contract Engineering Services
Crane Control Systems
Crane Controls
Crane Retrofits
Crane Retrofits: Single-Failure-Proof
Crane Service
Cranes
Cranes: Anti-Collision Systems
Cranes: Containment Polar
Cranes: Electric
Cranes: Fuel Building (Cask Handling)
Cranes: Fuel Pool
Cranes: Gantry
Cranes: Generically Licensable Type I
Cranes: Overhead
Cranes: Radio Controls
Cranes: Radwaste
Cranes: Safety System
Cranes: Single-Failure-Proof
Cranes: Type I
Design: Mechanical
Design: Structural
Electrical Master-Slave Manipulators
Electronic Components and Equipment
Engineering Services
Engineering: Electrical
Engineering: Equipment

Engineering: Mechanical
Engineering: Structural
Equipment Design
Equipment: Mechanical
Equipment: Mechanical
Equipment: Safety-Related
Fabrications
Fuel Handling Equipment
Fuel Pool Equipment
Fuel Transfer System Maintenance
Fuel Transfer Systems
Fuel: Spent, Transport
Fuel: Transport Flasks
Hoists
Hoists: Radio Controls
Inspection
Inspection Services
Inspection: Equipment
Installation: Equipment
Installation: Mechanical
Lifting: Heavy
Machining
Maintenance
Maintenance Services
Maintenance Services: Offsite
Maintenance Support
Maintenance: Equipment
Maintenance: Preventive
Manipulators: Robotic
Manufacturing Services
Materials Handling Equipment
Metal Fabrication
Metal Fabrication: Stainless Steel
Metal Fabrication: Steel
NDE Services
Nondestructive Testing & Evaluation
Nondestructive Testing Inspections
Nondestructive Testing Services
Outage Equipment
Outage Modification Implementation
Outage Support Services
Painting
Parts: O.E.M.
Parts: Procurement Assistance
Parts: Replacement
Parts: Replacement, Design
Parts: Spare
Parts: Used
Quality Assurance
Quality Assurance Programs
Radwaste Equipment
Radwaste Handling
Refueling Equipment
Refueling Equipment: Refurbishing
Remote Handling Equipment
Repair: General Equipment
Robotic Handling Equipment
Spent Fuel Storage Products
Spent Fuel Technology
Spent Fuel: Reracking
Staff Support: Engineering
Staff Support: Nondestruction Examination
Staff Support: Outage
Steel Components
Steel: Carbon
Steel: Stainless
Telerobotics
Testing: Acceptance
Testing: Safety-Related Components
Training: Engineering
Vacuum Systems
Welding

• **Apantec LLC,**

North Penn Business Parrk,
4500 North Cannon Avenue, Lansdale, PA
19446; Phone: (215) 362-5343, Fax: (267)
436-4034, Http://www.apantec.com, Email:
bbushnell@apantec.com, Contact: Craig Mills.

Air Monitoring Systems: Containment
Dosimeters: Electronic Pocket
Health Physics
Monitoring Systems: Airborne Radioactivity
Monitoring: Environmental Radiological
Monitoring: Radiation
Monitors: Area Radiation
Monitors: Iodine
Monitors: Liquid
Monitors: Noble Gas
Monitors: Particulate
Monitors: Portal
Nuclear Instrumentation and Controls
Radiation Vehicle Monitoring Systems



WE INVEST IN CUSTOMER SUCCESS™

• **AT&F Nuclear, Inc,**

Division of AT & F,
12314 Elmwood Ave. NW, Cleveland, OH
44111; Phone: (800) 544-5316, Fax: (216)
252-4963, Http://www.atfco.com, Email:
cantrellk@atfco.com, Contact: Kevin Cantrell.
(See advertisement on page 8)

ASME Certificate Holder
Casks: Storage
Casks: Transport
Commercial-Grade Dedication
Containers: Radwaste
Containers: Storage
Containers: Transport
Containment Structures
Dampeners: Pulsation
Decontamination Equipment (Cask)
Doors: Bullet Proof
Doors: Radiation Shielding
Equipment: Bullet Resisting
Equipment: Safety-Related
Fabrication: Tubular Products
Fabrications
Glove Boxes
Heat Exchangers
Material: ASME Code
Metal Fabrication
Metal Fabrication: Stainless Steel

Metal Fabrication: Titanium
 NPT Stamp Holder
 Pipe Assemblies
 Pressure Vessels
 Racks: Storage
 Reactor Internals
 Reactor Vessel Components
 Shielding
 Spent Fuel Storage Products
 Steel Components
 Welding: ASME Code



BHI Energy Companies:

Bartlett Nuclear, Inc., Bartlett Services, Inc., SUN Technical Services, Inc., Power Equipment Maintenance, Inc., AMES Group, LLC, WeldTech Services.

60 Industrial Park Rd., Plymouth, MA 02360;
 Phone: (508) 591-1149, Fax: (508) 591-1397,
 Http://www.bhienergy.com, Email: lauren.buckman@bhienergy.com, Contact: Lauren Buckman.

Air Filtration Units
 Air-Operated Valve Diagnostics
 ALARA Management Services
 Characterization: Facility
 Coatings
 Communications Systems
 Consulting
 Consulting: Decommissioning
 Consulting: Decontamination
 Consulting: Health Physics
 Consulting: Root Cause Analysis
 Consulting: Scaffolding Design/Engineering
 Consulting: Self-Assessment
 Consulting: Technical Staff
 Decommissioning Services
 Decontamination Equipment
 Decontamination Processes
 Decontamination Services
 Diagnostics: Valve
 Emergency Preparedness: Staff Support
 Employment Services
 Engineering Services
 Engineering: Cost
 Engineering: Design
 Engineering: Environmental
 Engineering: Field
 Engineering: Mechanical
 Engineering: Nuclear
 Engineering: Power Uprate
 Engineering: Quality
 Engineering: Radiological
 Engineering: Start-Up
 Engineering: Systems
 Environmental Management
 Environmental Monitoring Equipment
 Environmental Monitoring Services
 Environmental Remediation
 Health Physics
 Health Physics Services
 Heat Exchanger Maintenance
 HVAC: Ventilation Equipment
 Installation: Mechanical
 Installation: Setup
 Investigations: Pre-Employment Screening

Labor Management
 Maintenance Services
 Maintenance Support
 Maintenance: Preventive
 Maintenance: Valves
 Monitoring Systems: Remote
 Monitoring: Groundwater
 Motor Operators: Repair
 Operations Support
 Outage Support Services
 Personnel Services
 Procedure Development
 Project Management
 Radiation Detection/Monitoring Systems
 Radiological Protection Services
 Reactor Services
 Remediation Services
 Repair: General Equipment
 Review Support: Operational Readiness
 Risk Assessment
 Safety: Industrial
 Safety: Radiological
 Scaffolding
 Scaffolding Design/Engineering Services
 Scaffolding Erection Services
 Scaffolding Rental
 Spectroscopy Systems: Computer-Based
 Staff Support
 Staff Support: Craft Labor
 Staff Support: Decontamination
 Staff Support: Engineering
 Staff Support: Environmental Technologies
 Staff Support: Health Physics
 Staff Support: Instrumentation/Control
 Staff Support: Outage
 Staff Support: Planners
 Staff Support: Quality Assurance/Control
 Staff Support: Radiological
 Staff Support: Schedulers
 Staff Support: Specialists
 Staff Support: Technical
 Staff Support: Technical Staff
 Strippable Coatings
 Support Services: Operating Plant
 Training Support
 Training: Employee
 Training: Radiation Protection
 Training: Valves & Valve Actuators
 Turbine Generator Inspection
 Turbine Generator Maintenance
 Turbine Inspection
 Turbine Outage Management
 Turbines: Steam
 Valve Actuator
 Valve Analysis
 Valve Modification
 Valve Repair
 Valve Services
 Valve Testing
 Valves: Air Operated Globe
 Valves: Check
 Valves: Control
 Valves: Main Steam Isolation, Maintenance
 Valves: Motor Operated
 Waste Solidification Equipment
 Weld Repair
 Welding
 Welding: ASME Code
 Welding: Automated
 Welding: BWR Remote
 Welding: Cobalt Free Materials
 Welding: Hardfacing
 Welding: Narrow Groove, Automatic
 Welding: Overlay, Automatic
 Welding: Pipe & Pipe Fitting
 Welding: Remote
 Welding: Special
 Welding: Valve
 Writing: Procedure

Biodex Medical Systems, Inc.,

20 Ramsey Road, Shirley, NY 11967; Phone:
 (800) 224-6339, Fax: (631) 924-9241, Http://
 www.biodex.com, Email: info@biodex.com,
 Contact: Lila Corwin.

Analyzers: Multichannel
 Barriers: Clear Lead (Shielding)
 Barriers: Clear Lead Mobile
 Barriers: Lead
 Blocks/Bricks: Lead
 Cabinets: Shielded
 Calibrators: Radioisotope Dose
 Carrier: Radionuclide
 Chromatography
 Containers: Lead
 Containers: Radwaste
 Containers: Shielded
 Containers: Storage Products
 Containers: Waste
 Counters: Alpha/Beta
 Counters: Gamma
 Counters: Radiation
 Counters: Wipe Test
 Counting Systems: Thyroid Uptake
 Decontamination Supplies
 Detectors: Gamma
 Detectors: Radiation
 Detectors: Scintillation
 Detergents: Contamination Removing
 Dosimeter Chargers
 Dosimeter Readers: Automatic Pocket
 Dosimeters: Direct Reading
 Dosimeters: Electronic Pocket
 Dosimeters: Personal
 Dosimeters: Radiation
 Foil: Lead
 Gloves: Protective
 Instruments: Portable Survey
 Isolators: Digital Signal
 Labels: Warning
 Lead Shielding: New
 Meters: Digital Survey
 Meters: Radiation Survey
 Meters: Survey, Geiger-Mueller
 Monitors: Area Radiation
 Monitors: Portal
 Monitors: Radiation
 Nuclear: Shielding
 Planchets
 Probes: Geiger-Mueller, End Window
 Probes: Geiger-Mueller, Pancake
 Ratemeters: Alarming
 Refrigerators: Lead-Lined
 Rope: Warning
 Safes/Vaults: Lead Shielded
 Shielding
 Shielding Materials: Lead Glass
 Shielding: Custom
 Shielding: Lead
 Shielding: Lead Bricks
 Shielding: Portable
 Shielding: Radiation
 Shields: Bench-Top
 Shields: Mobile
 Shields: Mobile Lead
 Signs: Warning
 Waste Storage
 Windows: Clear Lead Viewing
 Wipes: Decontamination



- **BIRNS, Inc.,**
1720 Fiske Place, Oxnard, CA 93033; Phone:
(805)487-5393, Fax: (805)487-0427, Http://
www.birns.com, Email: service@birns.com,
Contact: Eric Birns.
(See advertisement on page 51)

Connectors: Electrical
Fuel Pool Equipment
Lighting
Lights: Underwater

- **Candu Energy Inc,**
2285 Speakman Dr., Mississauga L5K 1B1,
Ontario Canada; Phone: (905) 823-9040,
Fax: (905) 403-7420, Http://www.candu.
com, Email: rob.adams@candu.com, Contact:
Richard Moffett.
(See advertisement on page 67)

3D Laser Scanning of Facilities
Analysis: Engineering
Analysis: Reactor Physics
Analysis: Reliability
Analysis: Static
Analysis: Stress
Analysis: Structural
Analysis: Thermal
Consulting: Chemical Decontamination
Consulting: Decontamination
Consulting: Engineering
Consulting: Hazardous Waste Management
Consulting: Materials Analysis
Consulting: Materials Engineering
Consulting: Nuclear
Consulting: Nuclear Fuel Cycles
Consulting: Plant Life Extension
Consulting: Radwaste
Consulting: Reactor Engineering
Consulting: Reactor Materials
Consulting: Reactor Safety
Consulting: Remote Systems Applications
Consulting: Robotics
Consulting: Steam Generators
Consulting: Stress, Material
Consulting: Technical Assessments
Consulting: Thermal-Hydraulics
Consulting: Waste Management
Containment Analysis
ECC (Emergency Core Cooling) Strainers
Engineering Services
Feeder Services
Fuel Analysis
Fuel Channels
Fuel Handling Equipment
Fuel Inspection
Hydrogen Recombiners
Inflatable Seals
Inspection Equipment: Robotic
Inspection Equipment: Visual
Inspection: Steam Generator
Life Extension
Parts: Replacement, Design
Plant Life Management Services
Pump Seals
Reactor Analysis Software
Reactors: Heavy Water
Robots and Robotic Equipment
Safety Analysis
Seismic Analysis
Shielding Analysis
Software: Reactor Analysis

Software: Control Computer
Spent Fuel Storage Products
Steam Generator Chemical Cleaning
Tools: Inspection
Tools: Maintenance
Tools: Remote Handling
Ultrasonic Inspection
Waste Management Services

CartwrightDownes, Inc.,
650 Busse Hwy, Par, IL 60068; Phone:
(847)685-2727, Fax: (847)685-2702, Http://
www.cartwrightdownes.com, Email: Sandy.
Downes@CartwrightDownes.com, Contact:
Sandy Downes.

Investigations: Pre-Employment Screening

Cutting Edge Services Corporation,
1535 Old SR 74, Batavia, OH 45103; Phone:
(513) 388-0199, Fax: (513) 732-1248, Http://
www.cuttingedgeservices.com, Email:
beckman@cuttingedgeservices.com, Contact:
Timothy Beckman.

Concrete Cutting
Consulting: Decommissioning
Diamond Wire Sawing
Sawing

Diversified Technologies Services, Inc.,
2680 Westcott Boulevard, Knoxville, TN
37931; Phone: (865) 539-9000, Fax: (865) 539-
9001, Http://www.dts9000.com, Email: info@
dts9000.com, Contact: Charles Jensen.

Boric Acid Recovery
Containers: Steel
Dewatering & Drying
Dryers: Wet Solids
Equipment & Services: Chromate Removal
Equipment & Services: Reverse Osmosis
Equipment & Services: Silica Removal
Filter Media
Filters: Liquid
Filters: Underwater
Ion Exchange Equipment
Ion Exchange Media
Liners
Polymer Solidification Services
Radwaste Processing
Radwaste Volume Reduction
Sludge Removal
Storage Systems: Onsite
UltraFiltration
Vacuuming: Underwater
Waste Encapsulation
Waste Solidification



DRS Consolidated Controls, Inc.,
21 South Street, Danbury, CT 06810; Phone:
(203) 798-3030, Fax: (203) 798-3214, Http://
www.drs-cci.com, Email: sales@drs-cci.com,
Contact: Andrew Gaunt.

Control Panels: 1E
Control Room Consoles: Class 1E
Control Systems: Class 1E
Control Systems: Safety
Instrumentation/Control Systems: Class 1E
Transmitters: Diff. Press., Safety-Related
Transmitters: Safety-Related

Dufrane Nuclear Shielding, Inc.,
125 Price Road, Winsted, CT 06098; Phone:
(860) 379-2318, Fax: (860) 379-2325, Http://
www.dufrane.com, Email: support@dufrane.
com, Contact: Louis DeRitis.

Barriers: Security
Blanket Racks
Blocks/Bricks: High-Density Concrete
Cabinets: Shielded
Containers: Lead
Containers: Radwaste
Containers: Shielded
Containers: Steel
Containers: Storage
Containers: Waste
Lead Shielding: New
Metal Fabrication
Neutron Absorption Materials
Nuclear: Shielding
Outage Support: Radiation Protection
Radwaste Equipment
Security Booths
Shielding
Shielding Materials
Shielding Materials: Gamma
Shielding Materials: Polyethylene-Base
Shielding Windows
Shielding: Custom
Shielding: High-Density Concrete
Shielding: Lead
Shielding: Lead Bricks/Blocks
Shielding: Lead Hot Pours
Shielding: Lead-Plastic
Shielding: Neutron
Shielding: Portable
Shielding: Radiation
Shielding: X-Ray
Shields: Lead Frisker
Shields: Mobile
Storage Facilities
Storage Systems: Onsite
Waste Storage
Windows: Clear Lead Viewing
X-Ray: Shielding

E. H. Wachs,
600 Knightsbridge Pkwy, Lincolnshire, IL
60069; Phone: (847) 537-8800, Http://www.
ehwachs.com, Email: sgilmore@ehwachs.com,
Contact: Sherry Gilmore.

Actuators
Bits: Pipe Beveling Tool
Bits: Pipe Cutting Tool
Cutting Equipment: Underwater
Decommissioning Equipment
Decommissioning Services
Diagnostics: Valve
Drills
Engineering: Design
Equipment Design
Hydraulic Equipment
Lathes: Transportable
Machines: Milling
Machining: Flanges
Machining: Onsite
Maintenance: Equipment
Outage Equipment
Pipe Beveling Machinery
Pipe Beveling Tools: Rental
Pipe Cutting Machinery
Pipe Cutting Tools: Rental
Pipe End Finishing Machine
Refacing Equipment: Flanges
Rental: Equipment
Repair Equipment: Remote-Controlled

Repair: General Equipment
 Repairs: Underwater
 Saws
 Steam Generator Maintenance Equipment
 Stud Removal
 Tooling: Underwater
 Tools: Fabrication
 Tools: Hydraulic
 Tools: Maintenance
 Tools: Pipe Beveling
 Tools: Pipe Cutting
 Tools: Tubing Cutting
 Tools: Tubing, End Squaring
 Tools: Tubing: Squaring
 Tube Cutting Machinery
 Tube End Finishing Machine
 Vacuum Equipment
 Vacuum Systems
 Valve Actuator
 Valve Actuators: Electric
 Valve Actuators: Hydraulic
 Valve Actuators: Pneumatic
 Valve Diagnostic Systems
 Valve Repair
 Valve Repair Equipment
 Valves: Main Steam Isolation, Maintenance
 Welding Equipment
 Welding Equipment: Computer Controlled
 Welding Equipment: Gas Tungsten Arc Weld
 Welding Equipment: Orbital
 Welding Equipment: Remote
 Welding Equipment: Tube
 Welding: Automated



- **Ellis & Watts Global Industries, LLC.**,
 4400 Glen Willow Lake Ln., Batavia, OH
 45103; Phone: (513) 752-9000, Fax: (513)
 752-4545, [Http://www.elliswatts.com](http://www.elliswatts.com), Email:
jmenkhaus@elliswatts.com, Contact: Joseph J.
 Menkhaus.
 (See advertisement on page 47)

Absorbers: Charcoal
 Air Conditioning: Packaged
 Air Conditioning: Split
 Air Filtration Units
 Air Handling Units
 ASME Certificate Holder
 Condensing Units: Air Cooled
 Condensing Units: Water Cooled
 Coolers: Containment
 Coolers: Cubicle Coolers
 Coolers: Direct Expansion (DX) Refrigerant
 Coolers: Fan Coil Units
 Cooling Systems: Forced Air
 Dampers: Backdraft
 Dampers: Bubble Tight
 Dampers: Control
 Dampers: Electric
 Dampers: Fire
 Dampers: Isolation
 Dampers: Pneumatic
 Dampers: Tornado
 Doors: Blast

Doors: Radiation Shielding
 Fans: Axial
 Fans: Centrifugal
 Fans: Exhaust
 Fans: High-Pressure
 Fans: Ventilating
 Filter Housings
 Heat Exchangers
 Heat Exchangers
 Heaters: Electric
 Heaters: Hot Water
 Housings: Filter
 HVAC Systems
 HVAC: Ventilation Equipment
 Louvers
 Models: Heat Exchanger
 Models: HVAC Systems
 Motors: Safety-Related
 Pressure Vessels
 Tanks: Pressure
 Tanks: Stainless Steel
 Welding: ASME Code

Excel Modular Scaffold & Leasing Corporation,

17900 Excel Blvd, Walker, LA 70785; Phone:
 (860) 873-9987, Fax: (860) 873-1753, [Http://www.excelcaffold.com](http://www.excelcaffold.com), Email: jim.elkins@excelcaffold.com, Contact: James E. Elkins.

Scaffolding
 Scaffolding Couplers
 Scaffolding Design/Engineering Services
 Scaffolding Erection Services
 Scaffolding Maintenance
 Scaffolding Rental
 Scaffolding: Fall Arrest Equipment
 Scaffolding: Planks/Grating

FCI FLUID COMPONENTS INTERNATIONAL LLC

Fluid Components International (FCI),
 1755 La Costa Meadows Dr., San Marcos, CA
 92078; Phone: (760) 736-6125, Fax: (760)
 736-6250, [Http://www.fluidcomponents.com](http://www.fluidcomponents.com),
 Email: nuclear@fluidcomponents.com,
 Contact: Kenneth Christian.

Flowmeters
 Flowmeters: Mass
 Instrumentation/Control Systems: Class 1E
 Instrumentation: Nuclear
 Meters: Air Mass Flow
 Meters: Gas Flow
 Switches: Flow
 Switches: Level

- **G.D. Barri & Associates, Inc.**,
 6860 W. Peoria Ave., Peoria, AZ 85345; Phone:
 (623) 773-4010, Fax: (623) 773-2924, [Http://www.gdbarri.com](http://www.gdbarri.com), Email: georgia.barri@gdbarri.com,
 Contact: Georgia D. Barri.
 (See advertisement on page 72)

Calibration Services
 Consulting
 Consulting: Technical Staff
 Contract Engineering Services
 Maintenance Support
 Operations Support
 Staff Augmentation—See Staff Support
 Staff Support: Instrument Calibration
 Staff Support: Modifications
 Staff Support: Outage
 Staff Support: Planners
 Staff Support: Schedulers
 Staff Support: Specialists
 Staff Support: Technical
 Staff Support: Technical Staff
 Training: Instructor

Training: Job Analysis
 Training: Maintenance
 Training: Operations Personnel
 Training: Procedure Writing
 Training: Technical Staff
 Valves: Safety Relief, Maintenance

General Cable,

4 Tesseneer Drive, Highland Heights, KY
 41076; Phone: (859) 572-8664, Fax: (860)
 465-8869, [Http://www.GeneralCable.com](http://www.GeneralCable.com),
 Email: jpace@GeneralCable.com, Contact:
 Jason Pace.

Cable: Coaxial
 Cable: Control
 Cable: Fiber Optic
 Cable: Flame Resistant
 Cable: Instrumentation
 Cable: Radiation Resistant
 Cable: Safety-Related
 Cable: Switchboard
 Cable: Thermocouple

Golder Associates Ltd.,

6925 Century Avenue, Suite 100 Mississauga,
 ON L5N 7K2 Canada; Phone: (905) 567-4444,
 Fax: (905) 567-6561, [Http://www.golder.com](http://www.golder.com),
 Email: George_Schneider@golder.com,
 Contact: George Schneider.

Air Management
 Audits: Water Quality
 Characterization: Site
 Consulting: Acoustic Emission
 Consulting: Biological Sciences
 Consulting: Decommissioning
 Consulting: Engineering
 Consulting: Environmental
 Consulting: Environmental
 Consulting: Geohydrological Studies
 Consulting: Geohydrological Studies
 Consulting: Hazardous Materials Management
 Consulting: Health Physics
 Consulting: Health Physics
 Consulting: Licensing
 Consulting: Meteorological
 Consulting: Nuclear
 Consulting: Power Needs
 Consulting: Radiological
 Consulting: Radwaste
 Consulting: Risk Analysis
 Consulting: Seismic
 Consulting: Waste Management
 Emergency Preparedness Program
 Development
 Engineering: Environmental
 Engineering: Geotechnical
 Engineering: Low-Level Waste Remediation
 Environmental Impact Assessment
 Environmental Impact Assessment
 Industrial Hygiene Services
 Regulatory Compliance
 Remediation Services
 Remediation Services
 Thermal Plume Studies

- **Herguth Laboratories,**
 101 Corporate Place, Vallejo, CA 94590;
 Phone: (800) 645-5227, Fax: (707) 554-0109,
[Http://www.herguth.com](http://www.herguth.com), Email: lperry@herguth.com,
herguth.com, Contact: Linda Perry.
 (See advertisement on page 50)

Analysis: Chemical
 Analysis: Root Cause
 Chemistry Services
 Consulting: Maintenance
 Consulting: Maintenance Programs
 Failure Analysis
 Failure Analysis: Electron Microscopy
 Grease Analysis

Lab Analysis: Radiological
 Laboratory Services
 Lubrication Analysis
 Maintenance: Predictive
 Maintenance: Preventive
 Monitoring Technologies: Condition
 Oil Analysis
 Oil Analysis Equipment
 R&D Services
 R&D: Chemistry
 Testing: Chemical
 Testing: Laboratory
 Testing: Special



Air Sampling & Radiation Monitoring Equipment, Systems & Accessories

- **HI-Q Environmental Products Company,**
 7386 Trade ST, San Diego, CA 92121-2422;
 Phone: (858) 549-2820, Fax: (858) 549-9657,
 Http://www.HI-Q.net, Email: info@HI-Q.net,
 Contact: Marc Held.
 (See advertisement on page 41)

Air Samplers
 Air Samplers: Personal
 Air Sampling Systems
 Calibration Instruments
 Calibration Services
 Calibrators: Instrument
 Carbon: Activated
 Controllers: Flow
 Controllers: Mass Flow
 Environmental Monitoring Equipment
 Filter Cartridge
 Filter Housings
 Filter Media
 Filter Paper
 Filters: Activated Carbon
 Filters: Air Sampler
 Filtration Media: Carbon
 Flowmeters
 Flowmeters: Mass
 Health Physics Supplies
 Instrument Weatherhouses
 Instrumentation: Health Physics
 Instrumentation: Nuclear
 Instrumentation: Tritium
 Instruments: Air Velocity
 Instruments: Contamination Monitoring
 Meters: Air Mass Flow
 Meters: Air Velocity
 Monitoring Systems: Airborne Radioactivity
 Monitoring Systems: Environmental Radiation
 Monitoring: Air
 Monitoring: Environmental Radiological
 Monitoring: Radiation
 Monitors: Air
 Monitors: Alpha
 Monitors: Area
 Monitors: Area Radiation
 Monitors: Environmental
 Monitors: Iodine
 Monitors: Iodine Air
 Monitors: Particulate
 Monitors: Radiation
 Monitors: Radioactive Waste Storage
 Monitors: Stack Radiation
 Monitors: Tritium
 Personal Computers: Air Quality Sampling
 Pumps: Air Sampling
 Pumps: Centrifugal
 Pumps: Rotary Vane
 Pumps: Sampling
 Pumps: Vacuum
 Radiation Detection/Monitoring Systems

Sample Collection
 Sampling Systems
 Sampling Systems: Iso-Kinetic
 Valves: Control
 Valves: Needle



- **HukariAscendent,**
 4251 Kipling Street, Suite 580, Wheat Ridge,
 Colorado 80033; Phone: (303) 384-9079,
 Fax: (303) 277-1458, Http://www.hukari.com,
 Email: Robertp@hukari.com, Contact: Robert
 Plappert.
 (See advertisement on page 12)

Analysis: Engineering
 Analysis: Safety
 Consulting: Operations
 Consulting: Process Safety
 Consulting: Regulatory Compliance
 Engineering: Nuclear
 Operations Support
 Safety Management

- **ILD, Inc.,**
 8867 Highland Rd., #378, Baton Rouge, LA
 70808; Phone: (225) 769-2780, Fax: (225) 769-
 2751, Http://www.ildpower.com, Email: jack@
 ildpower.com, Contact: Jack Little.

Condenser Leak Detection
 Consulting: Balance-of-Plant
 Consulting: Modifications
 Engineering Services: BWR
 Engineering Services: PWR
 Engineering: Design
 Engineering: Power Uprate
 Engineering: Systems
 Staff Support: Engineering
 Testing: Special



- **iRobot Corporation,**
 8 Crosby Drive, Bedford, MA 01730; Phone:
 (781) 430-3000 X 5044, Http://www.irobot.
 com, Email: kmonti@irobot.com, Contact:
 Kim Monti.

Inspection Equipment: Robotic
 Robotic Handling Equipment
 Robots and Robotic Equipment
 Security Systems
 Tools: Robotic



- **James C. White Company,**
 10 Halton Road, Greenville, SC 29607; Phone:
 (864) 288-3102, Fax: (864) 288-3643, Http://
 www.JCWCO.com, Email: nuclearsales@
 JCWCO.com, Contact: John Detandt.

Cable Tray Supports
 Cable Trays
 Fabrications

Instrument Stands
 Instrumentation Supports
 Instrumentation Tray
 Manifolds
 Metal Fabrication
 Metal Fabrication: Stainless Steel
 Metal Fabrication: Steel
 Tube Clamps



ESTABLISHED 1788

- **Joseph Oat Corporation,**
 2500 Broadway, Camden, NJ 08104; Phone:
 (856) 541-2900 x205, Fax: (856) 541-
 0864, Http://www.josephoat.com, Email:
 mcdonaldj@josephoat.com, Contact: John
 McDonald.
 (See advertisement on page 37)

Accumulators
 Analysis: Criticality
 Analysis: Engineering
 Analysis: Heat Transfer
 Analysis: Thermal
 Analysis: Vibration
 ASME Certificate Holder
 Boilermaking
 Boilers
 Bolts
 Calculations: Code Sizing
 Cladding
 Commercial-Grade Dedication
 Condenser Tube Plugs
 Condensers
 Consulting: Engineering
 Consulting: Heat Exchangers
 Consulting: Heat Transfer
 Consulting: Seismic
 Consulting: Steam Generators
 Consulting: Tube Plugging
 Containers: Disposal
 Containers: Radwaste
 Containers: Storage
 Containers: Transport
 Contract Engineering Services
 Coolers: Containment
 Dampeners: Pulsation
 Design Services
 Design: Mechanical
 Design: Seismic
 Engineering Services
 Engineering: Design
 Engineering: Materials
 Engineering: Mechanical
 Engineering: Nuclear
 Equipment Design
 Equipment: Safety-Related
 Evaporators
 Fabrications
 Feedwater Heaters

Filters
 Heat Exchanger Analysis/Inspection Services
 Heat Exchangers
 Heat Exchangers: Rebuilding
 Heat Exchangers: Shell
 Heat Exchangers: Studies
 Machining: Heat Exchanger
 Machining: Safety-Related
 Material: ASME Code
 Metal Fabrication
 Metal Fabrication: Nickel & Nickel Alloy
 Metal Fabrication: Stainless Steel
 Metal Fabrication: Steel
 Metal Fabrication: Titanium
 NPT Stamp Holder
 Parts: Spare
 Pipe Assemblies
 Pipe Fabrication
 Pipe Fabrication: Class 1
 Pipe Fabrication: Class 2
 Pipe Fabrication: Class 3
 Plugs
 Plugs: Condenser
 Plugs: Feedwater Heater
 Pressure Vessel Analysis
 Pressure Vessels
 Racks: Storage
 Safety Equipment
 Seismic Analysis
 Shielding
 Steam/Water Separators
 Storage: Spent Fuel
 Tanks: Pressure
 Tanks: Storage
 Tubing: Stainless Steel
 Vessel Fabrication
 Weld Repair
 Welding
 Welding: ASME Code
 Zirconium



KINETRICS

- **Kinectrics Incorporated**,
 800 Kipling Avenue, Unit 2, Toronto, Ontario,
 M8Z 6C4 Canada; Phone: (416) 207-6000,
 Fax: (416) 207-6532, [Http://www.kinectrics.com](http://www.kinectrics.com),
 Email: cheryl.tasker-shaw@kinectrics.com,
 Contact: Cheryl Tasker-Shaw.
 (See advertisement on page 7)

Analysis: Chemical
 Analysis: Material Identification
 Analysis: Mixed Waste
 Analysis: Polymer
 Analysis: Radioactive Gas
 Analysis: Root Cause
 Analytical Services
 Clothing: Protective, Fabrics

Coatings Testing
 Concrete Repair Materials
 Consulting: Chemical Cleaning
 Consulting: Electrical
 Consulting: Environmental
 Consulting: Hazardous Waste Management
 Consulting: Radiochemistry
 Consulting: Radwaste
 Consulting: Root Cause Analysis
 Containers: Radwaste
 Corrosion Testing Laboratory
 Decontamination Processes
 Decontamination Services
 Engineering Services
 Engineering Services: PWR
 Environmental Qualification
 Equipment Qualification
 Equipment Qualification: Components, ASME
 Failure Analysis
 Failure Analysis: Electron Microscopy
 Fuel Channels
 Inspection Equipment: Development
 Inspection: Steam Generator
 Ion Exchange Resins
 Lab Analysis: Environmental
 Lab Analysis: Radiological
 Lab Research: Materials
 Motor Control Centers: Safety-Related Parts
 Nondestructive Testing Services
 Parts Evaluation
 Parts: Procurement Assistance
 Procurement
 Project Management
 Qualification: Supplier
 R&D Services
 R&D: Materials Performance
 R&D: Radwaste Treatment
 Radwaste
 Radwaste Analysis
 Seismic Analysis/Testing Equipment
 Testing: Chemical
 Testing: Electrical
 Testing: Laboratory
 Testing: Mechanical
 Tools: Fabrication
 Tools: Inspection
 Ultrasonic Inspection System Development

Laboratory Testing Inc.,
 2331 Topaz Drive, Hatfield, PA 19440; Phone:
 (800) 219-9095, Fax: (800) 219-9096, [Http://www.labtesting.com](http://www.labtesting.com),
 Email: sales@labtesting.com,
 Contact: Rick Heist.

Calibration Services
 Failure Analysis
 NDE Services
 Testing: Chemical
 Testing: Laboratory
 Testing: Mechanical
 Testing: Metallurgical



MIRION TECHNOLOGIES

- **Mirion Technologies**,
 Bishop Ranch 8, 3000 Executive Parkway Suite
 220, San Ramon, CA 94583; Phone: (925)
 543-0800, Fax: (925) 543-0808, [Http://www.mirion.com](http://www.mirion.com),
 Email: info@mirion.com,
 Contact: Kimberly Croxson.
 (See advertisement on page 17)

Access Control Systems
 Air Samplers
 Air Sampling Systems

Alarm Monitoring System
 Alarms: Dose
 Alarms: Rate
 Alarms: Safety-Related
 Analysis: Neutron Activity
 Analyzers: Multichannel
 Cable Assemblies
 Cable Assemblies: Cont Rod Position Indicator
 Cable Assemblies: Control Rod Drive
 Mechanism
 Cable Assemblies: Core Monitoring
 Cable Assemblies: Electronic
 Cable Assemblies: Fiber Optic
 Cable Assemblies: Radiation Resistant
 Cable Assemblies: Thermocouple
 Cable: Coaxial
 Cable: Flame Resistant
 Cable: High-Temperature
 Cable: Instrumentation
 Cable: Mineral Insulated
 Cable: Radiation Resistant
 Cable: Safety-Related
 Cable: Signal
 Cable: Thermocouple
 Calibration Services
 Calibration: Radiation Monitoring Systems
 Calibrators: Dosimeter
 Calibrators: Instrument
 Camera Systems: Miniature
 Camera Tubes: Radiation Hardened Television
 Cameras: Closed-Circuit Television
 Cameras: High-Temperature
 Cameras: Inspection
 Cameras: Underwater
 Chamber Detectors: Air Ionization
 Chambers: Fission
 Chambers: Gamma Ion
 Chambers: Ion
 Chambers: Ionization
 Chambers: Moveable In-Core Fission
 Chambers: Reactor Control
 Connectors: Electrical
 Connectors: Metal-to-Metal Clamp
 Connectors: Quick Disconnect, Safety-Related
 Consulting: Television Systems
 Control Systems: Class 1E
 Control Systems: Safety
 Counters: BF3
 Counters: Fission
 Counters: Gamma
 Counters: Radiation
 Counting Systems: Proportional
 Detector Refurbishment
 Detectors: BF3
 Detectors: Ex-Core
 Detectors: Gamma
 Detectors: Gas, Area
 Detectors: Geiger-Muller
 Detectors: In-Core
 Detectors: Neutron
 Detectors: Radiation
 Detectors: Radiation, Gas-Filled
 Detectors: Scintillation
 Dosimeters: Electronic Pocket
 Dosimeters: Electronic, Digital
 Dosimeters: Personal
 Dosimetry Services: TLD Badges
 Dosimetry Supplies: TLD
 Dosimetry Systems
 Feedthroughs: Fiber-Optic
 Fibrescopes: Rad Hardened
 Filters: Air Sampler
 Image Recognition Systems
 Inspection Equipment: Visual
 Instrumentation
 Instrumentation: Health Physics
 Instrumentation: Nuclear
 Instrumentation: Process Control
 Instrumentation: Radiation Protection
 Instruments

Instruments: Contamination Monitoring
 Instruments: Portable Survey
 Instruments: Safety-Related
 Maintenance Support
 Maintenance: Predictive
 Maintenance: Preventive
 Measurement Systems
 Meters: Radiation Survey
 Meters: Radon
 Meters: Survey
 Meters: Survey, Geiger-Mueller
 Meters: Survey, Neutron
 Monitoring Systems
 Monitoring Systems: Airborne Radioactivity
 Monitoring Systems: Environmental Radiation
 Monitoring Systems: Gas
 Monitoring Systems: Neutron
 Monitoring Systems: Neutron Flux
 Monitoring Systems: Remote
 Monitoring: Air
 Monitoring: Equipment, BWR
 Monitoring: Neutron
 Monitoring: Radiation
 Monitors: Air
 Monitors: Alpha
 Monitors: Area
 Monitors: Area Radiation
 Monitors: Beta
 Monitors: Contamination
 Monitors: Dose Rate
 Monitors: Gamma
 Monitors: Gas
 Monitors: Gas, Post-Accident
 Monitors: In-Core
 Monitors: Intermediate Range
 Monitors: Iodine
 Monitors: Iodine Air
 Monitors: Laundry Radioactivity
 Monitors: Liquid
 Monitors: Local Power Range
 Monitors: Noble Gas
 Monitors: Particulate
 Monitors: Personnel Contamination
 Monitors: Portal
 Monitors: Portal Beta
 Monitors: Portal Gamma
 Monitors: Process Radiation
 Monitors: Radiation
 Monitors: Source Range
 Monitors: Stack Radiation
 Monitors: Temperature
 Outage Equipment
 Penetrations: Containment
 Penetrations: Electrical
 Penetrations: Electrical, Adaptor Modules
 Preamplifiers: Instrumentation
 Probes: Gamma
 Probes: Geiger-Mueller
 Probes: Traversing In-Core Gamma
 Probes: Traversing In-Core Neutron
 Process Control Systems
 Radiation Detection/Monitoring Systems
 Radiation Vehicle Monitoring Systems
 Radiological Surveys
 Resistance Temp. Detector Modifications
 Resistance Temperature Detectors
 Seal Enclosures: Custom
 Sealing: Penetration
 Seals: Conduit
 Sensors: Temperature
 Software Development
 Software: Health Physics
 Software: Personnel Monitoring
 Spectroscopy Systems
 Spectroscopy Systems: Alpha
 Spectroscopy Systems: Gamma
 Spectroscopy: Gamma
 Spectroscopy: Neutron

Telemetry Systems
 Television Systems: Closed-Circuit
 Television Systems: Rad Hardened
 Television Systems: Underwater, Rad Hardened
 Thermocouple Attachment Units
 Thermocouples
 Thermocouples: In-Core
 Thermocouples: In-Core, Replacement
 Thermocouples: Safety-Related
 Training: Computer-Based, Health Physics
 Training: Dosimetry
 Training: Radiation Monitoring Systems
 Transducers: In-Line, High-Temperature
 Transducers: In-Line, Low-Temperature
 Transmitters: Radiation Monitors
 Transmitters: Personnel Dosimetry
 Valves: Emergency Service
 Valves: Explosive Actuated
 Valves: Safety-Related
 Video Inspection Systems
 Viewing Systems: Through-Wall

Doors: Radiation Shielding
 Equipment Qualification
 Equipment Qualification: Components, ASME
 Evaporators: Liquid Radwaste
 Flasks: Storage, Design and Testing
 Flasks: Transport, Design and Testing
 Fuel Assembly Grids
 Fuel Assembly Nozzles
 Fuel Casks: Barge
 Fuel Casks: Rail
 Fuel Floor Support
 Fuel Handling Equipment
 Fuel Pool Equipment
 Fuel Pool Liners
 Fuel Storage Racks
 Fuel Transfer Systems
 Heat Exchangers
 Heat Exchangers
 Heat Exchangers: Shell
 Hot Cells
 Integration: System
 Machining: Flanges
 Machining: Heat Exchanger
 Machining: Nozzle
 Machining: Safety-Related
 Manufacturing Services
 Material: ASME Code
 Materials: Qualified
 Metal Fabrication
 Metal Fabrication: Aluminum
 Metal Fabrication: Lead
 Metal Fabrication: Nickel & Nickel Alloy
 Metal Fabrication: Stainless Steel
 Metal Fabrication: Steel
 Metal Fabrication: Titanium
 Metallizing
 Nozzles
 NPT Stamp Holder
 NSSS: BWR
 Nuclear: Shielding
 Panels: Custom, Safety-Related
 Panels: Safety-Related
 Parts: BWR Spare
 Penetrations: Containment
 Pipe Fabrication
 Pipe Fabrication: Class 1
 Pipe Fabrication: Class 2
 Pipe Fabrication: Class 3
 Pressure Vessels
 R&D: Radwaste Disposal
 Radiation Shielding Systems
 Radwaste
 Radwaste Equipment
 Radwaste Equipment: Intermediate-Level
 Radwaste Equipment: Low-Level
 Radwaste Tanks
 Reactor Core Components
 Reactor Core Structure
 Reactor Internals
 Reactor Vessel Components
 Seismic Qualification
 Sleaving: Laser Welded
 Spent Fuel Storage Products
 Steam Generators
 Steel: Stainless
 Stop Gates
 Tanks: Ion Exchange
 Tanks: Pressure
 Tanks: Stainless Steel
 Tanks: Storage
 Trash Rakes & Racks
 Traveling Water Screens
 Vacuum Chambers
 Vehicles: Cask Transport
 Vessel Fabrication
 Welding
 Welding: ASME Code

mott corporation

Mott Corporation,
 84 Spring Ln., Farmington, CT 06032-3159;
 Phone: (860) 747-6333, Fax: (860) 747-6739,
 Http://www.mottcorp.com, Email: QUEST@
 mottcorp.com, Contact: Patty Dillon.

Filter Elements
 Filter Media
 Filters
 Filters: Backwash
 Filters: Condensate Polishing
 Filters: Gas
 Filters: Liquid
 Filters: Porous Metal
 Filters: Sintered Metal Fiber
 Filtration
 Filtration Equipment



- **Oregon Iron Works, Inc,**
 9700 SE Lawnfield Road, Clackamas, OR
 97015; Phone: (503) 653-6300, Fax: (503)
 653-5870, Http://www.oregoniron.com, Email:
 sales@oregoniron.com, Contact: Bradley
 Dunkin.
(See advertisement on page 27)

ASME Certificate Holder
 Casks: Storage
 Casks: Transport
 Commercial-Grade Dedication
 Containers: Radwaste
 Containers: Shielded
 Containers: Steel
 Containers: Transport
 Containers: Waste
 Containment Structures
 Doors: Blast
 Doors: Bullet Proof
 Doors: Manway
 Doors: Marine
 Doors: Plenum

Welding: Automated
Welding: Shell Girth
Welding: Special

PaR Systems, Inc.,

707 County Road E W, Shoreview, MN 55126;
Phone: (651) 484-7261, Fax: (651) 483-2689,
Http://www.par.com, Email: info@par.com,
Contact: Karen Knoblock.

Crane Control Systems
Crane Service
Cranes: Radwaste
Materials Handling Equipment
Robotic Handling Equipment
Robotic Programs: Utility, Devel. and Implem.
Robots and Robotic Equipment

**Peerless Electric,**

1401 West Market Street, Warren, OH 44485-2797; Phone: (800) 676-3651, Fax: (330) 393-6041, Http://www.peerlesselectric.com, Email: sales@peerlesselectric.com, Contact: Paul Petrich.

DC Motors
Motors: Auxiliary
Motors: Electric
Motors: Electric, Repair
Motors: Safety-Related
Nuclear Motors
Pumps: Canned Motor

Penn Iron Works, Inc.,

700 Old Fritztown Rd., P.O. Box 6858, Wyomissing, PA 19610-6858; Phone: (610) 777-7656 x212, Fax: (610) 777-2327, Http://www.penniron.com, Email: sphillippides@penniron.com, Contact: S.A. Philippides.

Equipment: Safety-Related
Fabrications
Heat Exchangers: Shell
Machining
Machining: Safety-Related
Metal Fabrication
Metal Fabrication: Nickel & Nickel Alloy
Metal Fabrication: Stainless Steel
Metal Fabrication: Steel
Parts: Spare
Steel Components
Tanks: Pressure
Tanks: Stainless Steel
Tanks: Storage
Vessel Fabrication
Welding
Welding: ASME Code

Powerfect,

1133 D Industrial Pkwy., Brick, NJ 08724-2582; Phone: (732) 202-1133, Fax: (732) 202-1556, Http://www.powerfect.com, Email: powerfect@verizon.net, Contact: Mary Jane Luddy.

Condenser Tube Plugs
Consulting: Heat Exchangers
Field Service

Heat Exchanger Analysis/Inspection Services
Heat Exchanger Maintenance
Heat Exchanger Tube Cleaning
Heat Exchangers: Rebuilding
Inspection Services
Leak Detection Services
Maintenance: Condenser
Plugs: Feedwater Heater
Retubing
Tube Plugging
Video Inspection Services

Precision Custom Components, LLC,

500 Lincoln St., York, PA 17404; Phone: (717) 848-1126, X2362, Fax: (717) 843-5733, Http://www.pcc-york.com, Email: jstouch@pcc-york.com, Contact: James C. Stouch.

Accumulators
ASME Certificate Holder
Calculations: Code Sizing
Casks: Storage
Casks: Transport
Cladding
Commercial-Grade Dedication
Containers: Fuel
Containers: Lead
Containers: Radwaste
Containers: Shielded
Containers: Steel
Containers: Storage
Containers: Transport
Containers: Waste
Containment Structures
Decontamination Equipment (Cask)
Doors: Radiation Shielding
Equipment: Safety-Related
Fabrications
Fuel Casks: Barge
Fuel Casks: Rail
Fuel Handling Equipment
Fuel Reprocessing Equipment
Fuel Storage Facilities
Fuel Storage Racks
Fuel: Transport Flasks
Glove Boxes
Heat Exchangers
Machining
Machining: Compressors
Machining: Generators
Machining: Heat Exchanger
Machining: Pumps
Machining: Rotor
Machining: Safety-Related
Machining: Thread Milling
Machining: Turbine
Machining: Valve
Material: ASME Code
Metal Fabrication
Metal Fabrication: Nickel & Nickel Alloy
Metal Fabrication: Stainless Steel
Metal Fabrication: Steel
Metal Fabrication: Titanium
Metal Facing
NPT Stamp Holder
Pressure Vessels
Pressurizers
Primary-Side Piping
Reactor Core Components
Reactor Core Structure
Reactor Head Repair
Reactor Internals

Reactor Vessel Components
Separators
Spent Fuel Storage Products
Steam Generators
Steam/Water Separators
Storage: Spent Fuel
Tanks: Chemical
Tanks: Pressure
Tanks: Stainless Steel
Tanks: Storage
Tools: Fabrication
Vacuum Chambers
Valves: Custom
Vessel Fabrication
Welding
Welding Developments
Welding: ASME Code
Welding: Automated
Welding: Hardfacing
Welding: Narrow Groove, Automatic
Welding: Overlay, Automatic
Welding: Remote
Welding: Shell Girth
Welding: Special

RCM Technologies, Inc.,

2500 McClellan Avenue, Pennsauken, NJ 08109; Phone: (856) 317-0200, x113, Fax: (856) 486-0802, Http://www.rcmt.com, Email: rich.timer@rcmt.com, Contact: Richard Timer.

Consulting
Design Services
Engineering Services
Environmental Qualification
Licensing Support Services
Modifications
Outage Support Services
Staff Support

**Remote Ocean Systems (ROS),**

5618 Copley Drive, San Diego, CA 92111; Phone: (858) 565-8500 ext:133, Fax: (858) 565-8808, Http://www.rosys.com. Contact: Rick Conroy.

Camera Positioners
Cameras: Underwater
Inspection: Equipment
Inspections: Underwater
Lights: Underwater

Sargent & Lundy,

55 E. Monroe St., Chicago, IL 60603; Phone: (312) 269-2000, Fax: (312) 269-3680, Http://www.sargentlundy.com, Email: robert.d.schuetz@sargentlundy.com, Contact: Bob Schuetz.

Analysis: Dynamic
Analysis: Engineering
Analysis: Environmental
Analysis: Hydraulic
Analysis: Reliability
Analysis: Risk
Analysis: Root Cause
Analysis: Severe Accident
Analysis: Stress
Analysis: Structural
Analysis: Thermal
Analysis: Waste
Assessment: Plant Condition
Audit Support: Technical Specialist
Audits: Quality
Availability Improvements

Commercial-Grade Dedication
 Computers: Upgrades
 Configuration Management
 Consulting
 Consulting: Ancillary Systems Design
 Consulting: Appendix R
 Consulting: Balance-of-Plant
 Consulting: Business Management
 Consulting: Computer Systems
 Consulting: Configuration Management
 Consulting: Data Acquisition Systems
 Consulting: Decommissioning
 Consulting: Decontamination
 Consulting: Design & Documentation
 Consulting: Design Basis Documentation
 Consulting: Digital Systems
 Consulting: Economic Analysis
 Consulting: Electrical
 Consulting: Engineering
 Consulting: Environmental
 Consulting: Fire Protection
 Consulting: Fluid Dynamic Analysis
 Consulting: FSAR Licensing Review
 Consulting: Hazardous Waste Management
 Consulting: HVAC Systems
 Consulting: Information Management
 Consulting: In-Service Inspection Programs
 Consulting: Instrumentation & Calibration
 Consulting: License Renewal
 Consulting: Licensing
 Consulting: Life Cycle Management
 Consulting: LOCA Analysis
 Consulting: Maintenance
 Consulting: Maintenance Programs
 Consulting: Management
 Consulting: Material Management
 Consulting: Materials Engineering
 Consulting: Modifications
 Consulting: Nuclear
 Consulting: Operations
 Consulting: Outage Management
 Consulting: Piping
 Consulting: Plant Life Extension
 Consulting: Plant Performance Improvement
 Consulting: Preventive Maintenance
 Consulting: Program Assessment
 Consulting: Prudence Studies
 Consulting: Quality Assurance
 Consulting: Quality Control
 Consulting: Radiation Analysis
 Consulting: Radwaste
 Consulting: Records Management Systems
 Consulting: Regulatory Compliance
 Consulting: Reliability Analysis
 Consulting: Residual Life Assessment
 Consulting: Risk Analysis
 Consulting: Root Cause Analysis
 Consulting: Security
 Consulting: Seismic
 Consulting: Self-Assessment
 Consulting: Setpoint Analyses
 Consulting: Siting
 Consulting: Strategic Planning
 Consulting: Structural
 Consulting: System Design
 Consulting: Technical Assessments
 Consulting: Thermal Analysis
 Consulting: Thermal-Hydraulics
 Consulting: Third Party Review
 Consulting: Valve Actuators
 Consulting: Valves
 Consulting: Waste Management
 Consulting: Water Treatment
 Corrosion Control
 Data Management Systems
 Database Design/Development
 Decommissioning Services
 Design Basis Reconstitution
 Design Services

Design: Electrical
 Design: Mechanical
 Design: Seismic
 Design: Structural
 Diesel Generator Engineering Studies
 Engineering Services
 Engineering Services: BWR
 Engineering Services: PWR
 Engineering: Civil
 Engineering: Control
 Engineering: Cost
 Engineering: Design
 Engineering: Electrical
 Engineering: Environmental
 Engineering: Instrumentation
 Engineering: Maintenance
 Engineering: Materials
 Engineering: Mechanical
 Engineering: Nuclear
 Engineering: Power Upgrade
 Engineering: Structural
 Engineering: Systems
 Environmental Qualification
 Equipment Qualification
 Failure Analysis
 Foundation Design & Analysis
 HVAC Systems
 Information Management Systems
 Inspection: In-Service
 Licensing Support Services
 Life Extension
 Maintenance Management Systems
 Maintenance Program Evaluation
 Maintenance Services
 Maintenance: Predictive
 Maintenance: Preventive
 Maintenance: Reliability Centered
 Management: Construction
 Modeling: Plant Systems
 Modifications
 Outage Management
 Outage Planning
 Outage Support Services
 Piping Analysis
 Piping Design
 Plant Upgrading/Upgrading
 Probabilistic Risk Assessment
 Probabilistic Safety Analysis
 Procedure Development
 Process Control Systems
 Project Management
 Quality Assurance Services
 Quality Control Services
 Quality Improvement Programs
 Radiation Assessment
 Radwaste Analysis
 Records Management
 Safety Analysis
 Safety Evaluations: Preparation
 Safety Evaluations: Program Reviews
 Security System Design
 Security System Upgrades
 Security: Hazards Analysis
 Seismic Analysis
 Seismic Qualification
 Shielding Analysis
 Snubber Analysis
 Software
 Software Development
 Software: Custom
 Software: Database Management
 Software: Document Control
 Software: Engineering Applications
 Software: Inventory Management
 Software: Maintenance
 Software: Plant Modeling
 Staff Support
 Staff Support: Designers
 Staff Support: Engineering
 Staff Support: Executive
 Staff Support: Instrumentation/Control
 Staff Support: Modifications
 Staff Support: Outage

Staff Support: Planners
 Staff Support: Quality Assurance/Control
 Staff Support: Technical
 Structural Integrity Assessment
 Support Services: Operating Plant
 Technology Transfer
 Training Support
 Training: Quality Assurance
 Training: Quality Improvement
 Training: Technical Staff
 Waste: Mixed, Analysis



- **Sciencetech, a business unit of Curtiss-Wright Flow Control Company,**
 200 South Woodruff Ave, Idaho Falls, ID 83401; Phone: (301) 668-1033, Fax: (301) 682-9209, [Http://http://sciencetech.cwfc.com](http://http://sciencetech.cwfc.com), Email: dmurphy@curtisswright.com, Contact: Donald Murphy.
(See advertisement on page 69)

Access Processing Software
 Alarm Monitoring System
 Alarms: Electronic Modules
 Alarms: Safety-Related
 Analysis: Criticality
 Analysis: Finite Element
 Analysis: Reliability
 Analysis: Risk
 Analysis: Safety
 Analysis: Severe Accident
 Assemblies: Printed Circuit
 Battery Chargers
 Cable Assemblies
 Cable Assemblies: Cont Rod Position Indicator
 Cable Assemblies: Control Rod Drive Mechanism
 Cable Assemblies: Core Monitoring
 Cable Assemblies: Electronic
 Cable Assemblies: Thermocouple
 Chemistry Data Management Systems
 Chemistry Services
 Circuit Breaker Maintenance
 Circuit Breaker Retrofitting
 Circuit Breakers: Safety-Related
 Cleaners: RV Flange
 Cleaners: RV Stud
 Cleaners: RV Stud Hole
 Computers: Plant Process
 Connectors
 Connectors: Electrical
 Consulting: Engineering
 Consulting: FSAR Licensing Review
 Consulting: License Renewal
 Consulting: Licensing
 Consulting: Nuclear
 Consulting: Nuclear Steam Supply System
 Consulting: Plant Performance Analysis
 Consulting: Plant Performance Improvement
 Consulting: Regulatory Compliance
 Consulting: Reliability Analysis
 Consulting: Risk Analysis
 Consulting: System Safety
 Control Panel Design
 Control Panels: 1E
 Control Panels: Safety-Related
 Control Rod Control System Maintenance
 Control Rod Drive Maintenance
 Control Room Consoles: Class 1E
 Control Systems: Class 1E
 Controllers: Analog

Controllers: Programmable
 Crane Retrofits
 Cranes
 Cranes: Fuel Building (Cask Handling)
 Cranes: Fuel Pool
 Design Services
 Design: Control Panel
 Design: Electrical
 Diesel Generators: Parts
 Electronic Components and Equipment
 Emergency Planning
 Engineering Services
 Engineering Services: BWR
 Engineering Services: PWR
 Engineering: Design
 Engineering: Electrical
 Engineering: Mechanical
 Engineering: Nuclear
 Environmental Qualification
 Equipment Qualification
 Equipment Qualification: Components, ASME
 Equipment Reliability
 Equipment Replacement
 Equipment: Safety-Related
 Fabrications
 Fuel Handling Equipment
 Fuel Transfer Systems
 Hoists
 I/O Controllers
 Indicators
 Information Services
 Information Services: Equipment Qualification
 Instrument Power Supplies
 Instrument Signal Isolation Devices
 Instrumentation
 Instrumentation/Control Systems
 Instrumentation/Control Systems: Class 1E
 Instrumentation/Control Systems: Repair
 Instrumentation/Control: Part Replacement
 Instrumentation: Nuclear
 Instrumentation: Process Control
 Instruments
 Instruments: Electronic
 Instruments: Safety-Related
 Instruments: Temperature Measuring
 Inventory Management
 Inventory Tracking Systems
 Isolators: Analog Signal
 Isolators: Digital Signal
 Licensing Support Services
 Life Extension
 Life Extension: Plant
 Life Extension: Plant, BWR
 Maintenance: Reliability Centered
 Manway Closure Services
 Manway Cover Handling System
 Metal Fabrication
 Monitoring Systems: Plant Safety
 Monitoring Technologies: Condition
 Nozzle Dam Installation
 Nozzle Dams
 Outage Support Services
 Panels: Custom, Safety-Related
 Panels: Instrument
 Panels: Power Distribution, Safety-Related
 Panels: Safety-Related
 Parts Evaluation
 Parts: BWR Spare
 Parts: O.E.M.
 Parts: Procurement Assistance
 Parts: Replacement
 Parts: Spare
 Parts: Used
 Plugs
 Power Supplies: Safety-Related
 Probabilistic Risk Assessment
 Probabilistic Risk Assessment: BWR
 Probabilistic Safety Analysis
 Quality Assurance
 Quality Assurance Services
 Quality Control Services
 Reactor Protection Systems
 Reactor Services

Records Management
 Recovery: Asset
 Refueling Equipment
 Refueling Equipment: Refurbishing
 Regulatory Compliance
 Risk Assessment
 Rod Control Maintenance Services
 Safety Analysis
 Safety Assessment
 Seals: Steam Generator
 Security Systems
 Seismic Analysis/Testing Equipment
 Software: Nuclear Safety
 Software: Plant Performance
 Software: Probabilistic Safety Analysis
 Spent Fuel Pool: Auxiliary Cooling
 Spent Fuel Technology
 Spent Fuel: Reracking
 Staff Augmentation—See Staff Support
 Steam Generator Maintenance Equipment
 Stud Tensioning Systems
 Switchboards: Safety-Related
 Switches: Pressure, Safety-Related
 Switches: Temperature, Safety-Related
 Switchgear: Safety-Related
 Tensioning Rings: Hand-Hole
 Tensioning Rings: Manway
 Testing: Acceptance
 Testing: Safety-Related Components
 Tools: Control Rod Drive Handling
 Tools: LPRM Handling
 Training: Chemistry
 Training: Nuclear Simulator
 Training: Operations Personnel
 Training: Safety Evaluations
 Valves: Safety-Related

- Seal Master Corporation,**
 368 Martinel Dr., Kent, OH 44240; Phone:
 (800) 477-8436, Fax: (330) 673-8242, Http://
www.sealmaster.com, Email: info@sealmaster.com, Contact: Thomas Hillery.
(See advertisement on page 69)

Actuators
 Air Lock Services
 Bags
 Couplings: Quick-Connect
 Gaskets: Radiation Resistant
 Hose
 Machining: Seals
 Nozzle Dams
 Plugs
 Plugs: Stud Hole
 Rubber Products: Custom
 Seals
 Seals: Bellows, Gate Valve
 Seals: Bellows, Globe Valve
 Seals: Diaphragm
 Seals: Flat
 Seals: Inflatable
 Separators
 Tubing
 Valve Actuators: Mechanical
 Valve Actuators: Pneumatic
 Valves: Bellows Sealed
 Valves: Custom
 Valves: Diaphragm

- SSM Industries, Inc.,**
 3401 Grand Ave., Pittsburgh, PA 15225-1507;
 Phone: (412) 777-5101 X-363, Fax: (412) 771-
 5382, Email: m.saucier@ssmi.biz, Contact:
 Mark Saucier.
(See advertisement on page 46)

Actuators
 Air Conditioning: Packaged
 Air Conditioning: Split
 Air Filtration Units
 Air Handling Units
 Blowers: Ventilation
 Damper Operators

Dampers: Backdraft
 Dampers: Bubble Tight
 Dampers: Control
 Dampers: Electric
 Dampers: Fire
 Dampers: Fire, Testing
 Dampers: High-Pressure
 Dampers: Isolation
 Dampers: Manual
 Dampers: Pneumatic
 Dampers: Relief
 Dampers: Tornado
 Dampers: Volume
 Doors: Access
 Doors: Bullet Proof
 Doors: Marine
 Doors: Plenum
 Doors: Radiation Shielding
 Ductwork
 Ductwork Hangers
 Ductwork Supports
 Equipment: Safety-Related
 Fabrications
 Fans: Axial
 Fans: Centrifugal
 Fans: Exhaust
 Fans: High-Pressure
 Fans: Ventilating
 Filter Housings
 Filtration Equipment
 Glove Boxes
 Housings: Filter
 HVAC Construction
 HVAC Systems
 HVAC Systems: AG-1 Testing
 HVAC Systems: Installation
 HVAC: Ventilation Equipment
 Louvers
 Metal Fabrication
 Metal Fabrication: Aluminum
 Metal Fabrication: Nickel & Nickel Alloy
 Metal Fabrication: Stainless Steel
 Metal Fabrication: Steel
 Panels: Custom, Safety-Related
 Seismic Qualification
 Sheet Metal
 Systems: HVAC
 Valve Actuators: Electric
 Valve Actuators: Electrohydraulic
 Valve Actuators: Electromechanical
 Valve Actuators: Pneumatic
 Variable Frequency Drives

- Technology for Energy Corporation (TEC),**
 10737 Lexington Dr., Knoxville, TN 37932-
 3294; Phone: (865) 966-5856, Fax: (865)
 675-1241, Http://www.tecnuclear.com,
 Email: sales@tecnuclear.com, Contact: Sarah
 Robertson.
(See advertisement on page 85)

Isolators: Analog Signal
 Isolators: Digital Signal
 Loose Part Monitoring Systems
 Materials Testing Equipment
 Measurement Services
 Nondestructive Testing Equipment
 Nondestructive Testing Services
 Valve Flow Monitoring Systems
 X-Ray Diffraction Equipment

The Delphi Groupe, Inc.,
 2211 S. IH-35, Ste. 400, Austin, TX 78741;
 Phone: (512) 462-1181, Fax: (512) 462-
 1187, Http://www.delphigroupe.com, Email:
mrandolph@delphigroupe.com, Contact: Mark
 Randolph.

Consulting: Computer Software
 Consulting: Engineering
 Consulting: Radwaste
 Decommissioning Services
 Emergency Preparedness Program
 Development

Emergency Preparedness: Staff Support
 Engineering: Design
 Engineering: Electrical
 Engineering: Mechanical
 Health Physics
 Procedure Development
 Project Management
 Safety: Industrial
 Safety: Radiological
 Staff Support: 10CFR20 Implementation
 Staff Support: Engineering
 Staff Support: Health Physics
 Staff Support: Industrial Hygiene
 Staff Support: Outage
 Training: Program Development Services

Thermo Scientific, NFMS Part of Thermo Fisher Scientific,

10010 Mesa Rim Rd., San Diego, CA 92121;
 Phone: (800) 488-4399, Fax: (858) 452-9250,
 Http://www.thermoscientific.com/nuclear,
 Email: ussdi.customersupport@thermofisher.com, Contact: Clark Artaud.

Cable Assemblies: Radiation Resistant
 Cable: Safety-Related
 Detectors: Ex-Core
 Detectors: Gamma
 Detectors: Neutron
 Instrument Racks: Seismic Multibay
 Instrument Signal Isolation Devices
 Instrumentation/Control Systems: Class 1E
 Instrumentation: Nuclear
 Monitoring Systems: Neutron
 Monitoring Systems: Neutron Flux
 Monitors: Dose Rate
 Monitors: Gamma
 Monitors: Intermediate Range
 Monitors: Source Range
 Power Supplies: Safety-Related
 Reactor Protection Systems



- **Thermo Scientific-CIDTEC, (Part of Thermo Fisher Scientific),**
 101 Commerce Blvd., Liverpool, NY 13088;
 Phone: (315) 451-9410, Fax: (315) 451-9421,
 Http://www.thermo.com/cidtec, Email: tony.chapman@thermofisher.com, Contact: Tony Chapman.
 (See advertisement on page 77)

Camera Systems: Miniature
 Camera Tubes: Radiation Hardened Television
 Cameras: Closed-Circuit Television
 Cameras: Inspection
 Cameras: Underwater
 Image Intensifier: Neutron
 Imaging Systems
 Inspection Equipment: Development
 Inspection Equipment: Visual
 Television Systems: Closed-Circuit
 Television Systems: Rad Hardened
 Television Systems: Underwater, Rad Hardened
 Video Inspection Systems

Tioga Pipe Supply Company Inc.,
 2450 Wheatshaf Ln., Philadelphia, PA 19137;
 Phone: (215) 831-0700, Fax: (215) 533-1645,
 Http://www.tiogapipe.com, Email: jshaw@tiogapipe.com, Contact: Jeff Shaw.

ASME Certificate Holder
 Cooling Water Pipe
 Electrodes: Welding
 Fasteners
 Fittings
 Flanges
 Forgings
 Material: ASME Code
 Metal: Alloy Bar
 Metal: Alloy Plate
 NQA-1 Qualified
 Pipe
 Pipe Bends
 Pipe Fabrication
 Pipe Fittings
 Pipe Fittings: Tee's
 Pipe: Alloy
 Pipe: Carbon-Steel
 Pipe: Copper Alloy
 Pipe: Corrosion-Resistant
 Pipe: Stainless Steel
 Sheet Metal
 Steel: Carbon
 Steel: Stainless
 Tube: Copper Alloy
 Tubing
 Tubing: Carbon Steel
 Tubing: Corrosion-Resistant
 Tubing: Stainless Steel
 Tubing: Titanium

- **TW Metals - Nuclear Materials Solutions,**
 880 Brickworks Drive, Leetsdale, PA 15056;
 Phone: (724) 251-4700, Fax: (724) 251-4701,
 Http://www.twmetals.com, Email: franz.schmidt@twmetals.com, Contact: Franz Schmidt.
 (See advertisement on page 55)

ASME Certificate Holder
 Bolts
 Bolts: Anchor
 Cladding
 Commercial-Grade Dedication
 Fasteners
 Fittings
 Flanges
 Forging Copper
 Forging Copper Alloy
 Forgings
 Heat Exchangers: Tubes
 Lead: All Forms
 Material: ASME Code
 Materials: Qualified
 Metal: Alloy
 Metal: Alloy Bar
 Metal: Alloy Plate
 Metal: Expanded
 Metal: High-Temperature
 Metal: Lead Alloy
 Metal: Perforated
 Metal: Pure Lead
 Nickel
 Nuclear: Shielding
 Pipe Fittings

Pipe Fittings: Flanged-Weldneck-Slip On
 Pipe Fittings: High-Alloy Steel
 Pipe Fittings: Low-Alloy Steel
 Pipe Fittings: Miscellaneous Metal
 Pipe Fittings: Tee's
 Pipe: Alloy
 Pipe: Aluminum
 Pipe: Carbon-Steel
 Pipe: Copper
 Pipe: Copper Alloy
 Pipe: Corrosion-Resistant
 Pipe: High-Alloy Steel
 Pipe: Low-Alloy
 Pipe: Stainless Steel
 Pipe: Titanium
 Pipe: Zirconium
 Plate: Copper
 Plugs
 Sheet Copper
 Sheet Copper Alloy
 Sheet Metal
 Shielding Materials
 Shielding: Sheet
 Steel: Carbon
 Steel: Stainless
 Studs
 Tube Fittings
 Tube: Copper
 Tube: Copper Alloy
 Tubing
 Tubing: Alloy
 Tubing: Aluminum
 Tubing: Calandria
 Tubing: Carbon Steel
 Tubing: Corrosion-Resistant
 Tubing: Metal
 Tubing: Pressure
 Tubing: Stainless Steel
 Tubing: Titanium
 Tubing: Zirconium
 Welding Materials

Underwater Construction Corporation,
 110 Plains Rd., Essex, CT 06426; Phone: (860) 575-0488, Fax: (860) 767-0612, Http://www.uccdrive.com, Email: pmcdermott@uccdrive.com, Contact: Philip G Mcdermott.

Coating: Underwater
 Coatings
 Coatings Testing
 Cooling Water Intake Maintenance
 Cutting: Underwater
 Diving
 Fuel Floor Support
 Fuel Transfer Systems
 Inspections: Underwater
 Installation: Fuel Rack
 Maintenance Services: Underwater
 Radwaste Volume Reduction
 Reactor Repair: Underwater, BWR
 Reactor Services
 Repairs: Underwater
 Spent Fuel: Reracking
 Tooling: Underwater
 Welding: Underwater Wet



**GREEN, CLEAN,
SUSTAINABLE**

- **UniTech Services Group, Inc.,
Div. of Unifirst Corp.,**
295 Parker St., P.O. Box 51957, Springfield,
MA 01151; Phone: (413) 543-6911, X16, Fax:
(413) 543-2975, [Http://www.UniTechUS.com](http://www.UniTechUS.com),
Email: gjohnstone@UniTechUS.com,
Contact: Steve Hofstatter.
(See advertisements on page 18 and 32)

Bags
Bags: Laundry
Cleaning Service
Cleaning: Chemical Processes
Cleaning: CO2 Blast
Clothing: Protective
Clothing: Protective, Fabrics
Containers: Storage
Containers: Transport
Decontamination Services
Decontamination Services: Offsite
Decontamination Supplies
Fabrics: Flame Retardant
Gloves: Protective
Grit Blasting
Health Physics Supplies
Hoods: Respirator
Laundry Services
Laundry: Water Wash
Laundry: Water Wash: Mobile
Maintenance: HEPA Systems
Monitoring: Contamination
Monitors: Contamination
Monitors: Laundry Radioactivity
Monitors: Waste
Outage Support: Radiation Protection
Protective Clothing Lease
Radiological Protection Services
Radwaste Treatment Services
Radwaste Volume Reduction
Respirator Cleaning Equipment
Respirators
Rope: Warning
Safety Equipment
Scaffolding Rental
Shoe Covers: Protective
Sleeving
Staff Support: Health Physics
Staff Support: Laundry Collection
Staff Support: Outage
Swipes: Decontamination

Tape: Duct
Tape: Warning
Tarps
Vacuums: HEPA-Filtered
Wipes: Decontamination

Uticom Systems Inc.,
109 Independence way, Coatesville, PA 19320;
Phone: (610) 857-2986, Fax: (610) 857-2986,
Email: jennifer@uticom.net, Contact: Jennifer
Martin.

Cable Markers
Cable: Fiber Optic
Labels
Labels: Bar Coded
Labels: Warning
Markers: Fiber Optic
Markers: Industrial
Signs: Warning
Tags

Valcor Engineering Corporation,
2 Lawrence Rd., Springfield, NJ 07081;
Phone: (973) 467-8480 EXT 7226, Fax: (973)
467-3365, [Http://www.valcor.com](http://www.valcor.com), Email:
stevegatcomb@valcor.com, Contact: Steve
Gatcomb.

ASME Certificate Holder
Check Valve Application Review
Connectors: Quick Disconnect, Safety-Related
Diagnostics: Valve
Diagnostics: Valve Actuator
Equipment Qualification: Components, ASME
Instrumentation/Control Systems: Class 1E
Instrumentation: Nuclear
Instrumentation: Packless
Manifolds
Manifolds: Packless Globe and Instrumentation
Solenoid Operated Valve Applications
Solenoid Operated Valve Diagnostics
Solenoid Operated Valve Repair
Solenoids
Training: Valves & Valve Actuators
Valve Actuator
Valve Actuators: Electric
Valve Assemblies
Valve Diagnostic Systems
Valves
Valves: Air Operated Globe
Valves: Bellows Sealed
Valves: Check
Valves: Custom
Valves: Diaphragm
Valves: Diverter
Valves: Gate
Valves: Globe
Valves: High-Pressure
Valves: Isolation
Valves: Metering
Valves: Needle
Valves: Packless
Valves: Pilot
Valves: Safety-Related
Valves: Sampling
Valves: Solenoid

- **Westerman Nuclear,**
245 N. Broad St., Bremen, OH 43107; Phone:
(800) 338-8265, Fax: (740) 569-4111, [Http://](http://www.westermancompanies.com)
www.westermancompanies.com, Email:
bmoore@westermancompanies.com, Contact:
William Moore.
(See advertisement on page 75)

ASME Certificate Holder
Decontamination: Steel Equipment
Electrical Panels: Control
Equipment Qualification: Components, ASME
Equipment Replacement
Equipment: Safety-Related
Fabrications
Fittings: Welding
Heat Exchangers
Heat Exchangers
Heat Exchangers: Shell
Heat Exchangers: Tubes
Machining
Machining: Heat Exchanger
Materials Characterization
Materials: Qualified
Metal Fabrication
Metal Fabrication: Nickel & Nickel Alloy
Metal Fabrication: Stainless Steel
Metal Fabrication: Steel
Meters: Gas Flow
NDE Services
NDE Services: Radiographic Testing
Nondestructive Testing & Evaluation
Pressure Vessels
Radwaste Equipment
Radwaste Equipment: Low-Level
Radwaste Tanks
Retubing
Sludge Vessels
Tanks: Chemical
Tanks: Pressure
Tanks: Stainless Steel
Tanks: Storage
Welding
Welding: ASME Code
Welding: Automated

- **Westinghouse Electric Company,**
1000 Westinghouse Drive, Cranberry
Township, PA 16066; Phone: (412) 374-
6737, Fax: (724) 940-8518, [http://www.](http://www.westinghousenuclear.com)
[westinghousenuclear.com](http://www.westinghousenuclear.com), Email: [shawsa@](mailto:shawsa@westinghouse.com)
[westinghouse.com](mailto:shawsa@westinghouse.com), Contact: Scott Shaw.
(See advertisement on page 115)

WMG, Inc.,
16 Bank St., Peekskill, NY 10566; Phone:
(914) 736-7100, Fax: (914) 736-7170, [Http://](http://www.wmginc.com)
www.wmginc.com, Email: [tduberville@](mailto:tduberville@wmginc.com)
[wmginc.com](mailto:tduberville@wmginc.com), Contact: Thomas Duberville.

ALARA Management Services
BWR Radiological Analysis
Consulting: Radiological
Consulting: Radwaste
Consulting: Regulatory Compliance
Consulting: Waste Management
Containers: Large-Component SCO Wraps
Containers: Radwaste
Containers: Steel
Decommissioning Services
Dewatering Services
Engineering: Radiological

Licensing Support Services
 Radwaste
 Radwaste Disposal Services
 Radwaste Handling
 Radwaste Management Services
 Radwaste Packaging
 Radwaste Processing
 Regulatory Compliance
 Remote Handling Equipment
 Shielding Analysis
 Software: Radiological Data Management
 Staff Support: Engineering
 Staff Support: Licensing
 Staff Support: Radiological
 Tools: Remote Handling
 Training: Radioactive Materials Handling
 Training: Waste Management
 Waste Processing

Wyle Laboratories, Inc.,
 7800 Hwy. 20 W, Huntsville, AL 35806;
 Phone: (256) 716-4283, Fax: (256) 837-3363,
 Http://www.wyle.com, Email: greg.mason@wyle.com, Contact: Greg Mason.

Analysis: Root Cause
 Analysis: Vibration
 Calibration Services
 Circuit Breaker Retrofitting
 Circuit Breakers: Safety-Related
 Commercial-Grade Dedication
 Contactors: Safety-Related
 Control Panels: 1E
 Control Panels: Safety-Related
 Converters: Safety-Related
 Data Recorders: Seismic Qualified
 Diesel Generators: Parts
 Engineering Services
 Equipment Qualification
 Equipment Replacement
 Equipment: Safety-Related
 Failure Analysis
 Field Service
 Fuse Holders: Safety-Related
 Fuses: Safety-Related
 Indicator Lights: Safety-Related
 Indicators: Panel Mounted
 Information Services: Equipment Qualification
 Instrument Power Supplies
 Instruments: Safety-Related
 Inverters
 Life Extension
 Materials: Qualified
 Motor Control Centers: Safety-Related
 Motor Control Centers: Safety-Related Parts
 Motor Starters: Safety-Related
 Motors: Safety-Related
 Panels: Custom, Safety-Related
 Panels: Power Distribution, Safety-Related
 Panels: Safety-Related
 Parts: O.E.M.
 Parts: Replacement
 Parts: Spare
 Power Supplies: Safety-Related
 R&D: Fluid Mechanics
 Relays: Safety-Related
 Seismic Qualification
 Snubber Repair
 Snubber Testing
 Solenoids
 Switches: Limit
 Switches: Pressure, Safety-Related
 Switches: Temperature, Safety-Related

Switches: Thermocouple
 Switchgear: Safety-Related
 Terminal Blocks: Safety-Related
 Test Loops
 Test Stands: Valve
 Testing
 Testing: Electrical
 Testing: Laboratory
 Testing: LOCA Conditions
 Testing: Mechanical
 Testing: Mechanical & Irradiation
 Testing: Safety-Related Components
 Testing: Special
 Thermocouples: Safety-Related
 Transducers: Safety-Related
 Transfer Switches: 1E
 Transformers: Safety-Related
 Transmitters: Diff. Press., Safety-Related
 Transmitters: Safety-Related
 Uninterruptible Power Supply: Safety-Related
 Valve Testing
 Voltage Regulators: Safety-Related



• **Zachry Nuclear Engineering, Inc.,**
 14 Lords Hill Road, Stonington, CT 06348;
 Phone: (860) 405-3054, Fax: (860) 446-8292,
 Http://www.zhi.com, Email: ApicelliL@zhi.com, Contact: Lisa Apicelli.
(See advertisement on page 11)

Analysis: Engineering
 Analysis: Finite Element
 Analysis: Heat Transfer
 Analysis: Hydraulic
 Analysis: Root Cause
 Analysis: Safety
 Analysis: Stress
 Analysis: Structural
 Analysis: Support
 Analysis: Thermal
 Analysis: Vibration
 Construction
 Consulting: Ancillary Systems Design
 Consulting: Appendix R
 Consulting: Balance-of-Plant
 Consulting: Computer Software
 Consulting: Control Systems
 Consulting: Cooling Systems
 Consulting: Data Acquisition Systems
 Consulting: Decommissioning
 Consulting: Design Assessment
 Consulting: Design Basis Documentation
 Consulting: Design Reports
 Consulting: Electrical
 Consulting: Engineering
 Consulting: Engineering Mechanics
 Consulting: Erosion/Corrosion Program
 Consulting: Fire Protection
 Consulting: Fluid Dynamic Analysis
 Consulting: Fluid Flow
 Consulting: FSAR Licensing Review
 Consulting: Heat Exchangers
 Consulting: Heat Transfer
 Consulting: HVAC Systems
 Consulting: Hydraulic
 Consulting: Instrumentation & Calibration

Consulting: License Renewal
 Consulting: Life Cycle Management
 Consulting: Margin Management Programs
 Consulting: Modifications
 Consulting: Pipe Support
 Consulting: Piping
 Consulting: Plant Life Extension
 Consulting: Plant Performance Analysis
 Consulting: Plant Performance Improvement
 Consulting: Project Management
 Consulting: Quality Assurance
 Consulting: Regulatory Compliance
 Consulting: Root Cause Analysis
 Consulting: Setpoint Analyses
 Consulting: Structural
 Consulting: System Design
 Consulting: System Safety
 Consulting: Technical Assessments
 Consulting: Thermal Analysis
 Consulting: Thermal-Hydraulics
 Consulting: Third Party Review
 Consulting: Trend Analysis Program
 Consulting: Ventilation System
 Control Panel Design
 Control Systems
 Data Acquisition Systems
 Database Design/Development
 Design Basis Reconstitution
 Design Services
 Design: Electrical
 Design: Mechanical
 Design: Seismic
 Design: Structural
 Engineering Services
 Engineering Services: BWR
 Engineering Services: PWR
 Engineering: Control
 Engineering: Design
 Engineering: Electrical
 Engineering: Instrumentation
 Engineering: Mechanical
 Engineering: Nuclear
 Engineering: Power Uprate
 Engineering: Quality
 Engineering: Structural
 Engineering: Systems
 Environmental Qualification
 Fire Protection
 Heat Exchanger Analysis/Inspection Services
 Heat Exchangers: Studies
 Instrumentation/Control Systems
 Licensing Support Services
 Modeling: Plant Systems
 Models: Heat Exchanger
 Models: HVAC Systems
 Models: Power Plant
 Models: Power Plant, Database
 Models: Thermal Hydraulic System
 Piping Analysis
 Piping Design
 Project Management
 Safety Assessment
 Safety Evaluations: Preparation
 Security System Design
 Security System Upgrades
 Seismic Analysis
 Software Development
 Software Validation
 Software Verification
 Software: Plant Modeling
 Software: Plant Performance
 Software: Power Systems Analysis
 Software: Process Control

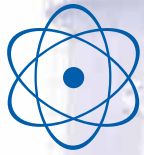

Bigge

POWER CONSTRUCTORS

Heavy Rigging and Transportation



Single Failure Proof Hoist for Sale

NOW WITH EVEN MORE LIFTING POWER:

The AFRD Super Crane for the next generation of modular construction:

- One crane set up location for a 2 unit site
- No loss of service from crane relocation down time
- More flexible construction erection sequences
- Full site/hook service covering 2 units and laydown/module assembly yard
- Schedule acceleration
- No site obstruction



**Please contact:
Gedge Knopf**

**+1 (510) 638-8100
biggsolutions@bigge.com**

Corporate Capabilities Participants

Aerofin	86	Herguth Laboratories	89	Technology for Energy Corporation (TEC)	95
American Crane & Equipment Corp.	86	HI-Q Environmental Products Company	90	The Delphi Groupe, Inc.	95
Apantec LLC.....	86	HukariAscendent.....	90	Thermo Scientific, NFMS Part of Thermo Fisher Scientific	96
AT&F Nuclear, Inc.....	86	ILD, Inc.....	90	Thermo Scientific-CIDTEC	96
BHI Energy	87	iRobot Corporation	90	Tioga Pipe Supply Company Inc.....	96
Biodex Medical Systems, Inc.	87	James C. White Company	90	TW Metals - Nuclear Materials Solutions	96
BIRNS, Inc.....	88	Joseph Oat Corporation.....	90	Underwater Construction Corporation	96
Candu Energy Inc.....	88	Kinectrics Incorporated.....	91	UniTech Services Group, Inc.	97
CartwrightDownes, Inc.	88	Laboratory Testing Inc	91	Uticom Systems Inc.	97
Cutting Edge Services Corporation	88	Mirion Technologies	91	Valcor Engineering Corporation	97
Diversified Technologies Services, Inc.	88	Mott Corporation	92	Westerman Nuclear	97
DRS Consolidated Controls, Inc.....	88	Oregon Iron Works, Inc	92	Westinghouse Electric Company	97
Dufrane Nuclear Shielding, Inc.	88	PaR Systems, Inc.	93	WMG, Inc.	97
E. H. Wachs.....	88	Peerless Electric	93	Wyle Laboratories, Inc.....	98
Ellis & Watts Global Industries, LLC.	89	Penn Iron Works, Inc.	93	Zachry Nuclear Engineering, Inc	98
Excel Modular Scaffold & Leasing Corporation.....	89	Powerfect	93		
Fluid Components International (FCI)	89	Precision Custom Components, LLC.....	93		
G.D. Barri & Associates, Inc.	89	RCM Technologies, Inc.	93		
General Cable.....	89	Remote Ocean Systems.....	93		
Golder Associates Ltd.	89	Sargent & Lundy	93		
		Sciencetech, a business unit of Curtiss-Wright Flow Control Company	94		
		Seal Master Corporation	95		
		SSM Industries, Inc.....	95		

Web Directory of Advertisers

AAF

www.aafintl.com

Aerofin Corporation

www.aerofin.com

American Crane & Equipment Corporation

www.americancrane.com

AREVA NP, Inc.

www.areva.com

AT&F Nuclear, Inc

www.atfnuclear.com

AZZ Incorporated

www.azz.com/nli

Bechtel Power

www.bechtel.com

Bigge Power Constructors

www.bigge.com

Birns

www.birns.com

Cameco Fuel Manufacturing

www.cameco.com

Candu Energy, Inc.

www.candu.com

Ceradyne Boron Products

www.ceradyne.com

Chatham Steel Corporation

chathamsteel.com

Copes-Vulcan, An SPX Brand

www.spx.com

Day & Zimmermann ECM

www.dayzim.com

Diakont

www.diakont.com

Ellis & Watts Global Industries, LLC

www.elliswatts.com

Energy Steel & Supply Company

www.energysteel.com

EST Group, a business unit of Curtiss-Wright Flow Control Company

www.estgrp.cwfc.com

Fairbanks Morse Engine

www.fairbanksmorsenuclear.com

Fauske & Associates, LLC

www.fauske.com

Frham Safety Products, Inc.

www.frhamsafety.com

Frontier Technology Corporation

www.frontier-cf252.com/

G. D. Barri & Associates, Inc.

www.gdbarri.com

GE Hitachi Nuclear Energy

ge-energy.com/nuclear

Herguth Laboratories, Inc.

www.herguth.com

HF Controls

www.doosan.com

Hi-Q Environmental Products Company

www.HI-Q.net

HukariAscendent

www.hukari.com

Joseph Oat Corporation

www.josephoat.com

Kinectrics Inc.

www.kinectrics.com

Mirion Technologies, Inc.

www.mirion.com

Mohawk Industrial & Nuclear Supply, Inc.

www.mohawksafety.com

NUCON International, Inc.

www.nucon-int.com/

Oregon Iron Works, Inc.

www.oregoniron.com

Performance Contracting Inc. (PCI)

www.pcg.com

Rolls-Royce

www.rolls-royce.com

Schulz Electric Company

www.schulzelectric.com

Scientech, a business unit of Curtiss-Wright Flow Control Company

scientech.cwfc.com/

Seal Master

www.sealmaster.com

Siempelkamp Nukleartechnik GmbH

www.siempelkamp.com

SSM Industries, Inc.

www.ssmi.biz

Structural Integrity Associates, Inc.

www.structint.com

Technology for Energy Corporation (TEC)

www.tec-usa.com

tecnatom, s.a.

www.tecnatom.es

The Shaw Group Inc., Nuclear Power Division

www.shawgrp.com

Thermo Scientific- CIDTEC

www.thermo.com/cidtec

TPC Wire & Cable

www.tpcwire.com

Tri Tool Inc.

www.tritool.com

Trust Manufacturing

www.trustmfg.com

TW Metals- Nuclear Materials Solutions

www.twmetals.com

UniTech Services Group

www.unitechus.com

URENCO Ltd.

www.urenco.com

Weldstar

www.weldstar.com

Westerman Nuclear

www.westermancompanies.com

Westinghouse Electric Company LLC

www.westinghousenuclear.com

Zachry Nuclear Engineering, Inc

www.zhi.com

Suppliers

• Denotes advertiser

§ Denotes Corporate Capabilities Participant

“**Atomexpo**” LLC, Bolshaya Tulsкая, 10/38, Moscow 115191, Russia; Phone: (495) 663-38-21, Fax: (495) 663-38-20, [Http://atomexpo.com](http://atomexpo.com), Email: MMPancheshuk@atomexpo.com, Contact: Marina Pancheshuk.

- **AAF International**, P.O. Box 35690, Louisville, KY 40232-5690; Phone: (502) 637-0279, Fax: (502) 637-0141, [Http://www.aafintl.com](http://www.aafintl.com), Email: jmagner@aafintl.com, Contact: Joe Magner.
(See advertisement on page 41)

Acromag, Inc., 30765 S. Wixom Rd. P.O. Box 437, Wixom, MI 48393-7037; Phone: (248) 295-0880, Fax: (248) 624-9234, [Http://www.acromag.com](http://www.acromag.com), Email: khaldenwanger@acromag.com, Contact: Karen Haldenwanger.

Advanced Consulting Group, Inc., Executive Towers, 5901 N. Cicero Ave., Ste. 603, Chicago, IL 60646-5711; Phone: (773) 481-9500, Fax: (773) 481-9981, Email: advensgrp@aol.com, Contact: Thomas Litka.

- § **Aerofin**, 4621 Murray Pl., Lynchburg, VA 24502; Phone: (434) 845-7081, Fax: (434) 528-6281, [Http://www.aerofin.com](http://www.aerofin.com), Email: belliott@aerofin.com, Contact: Brian Elliott.
(See advertisement on page 45)
(See corporate capabilities on page 86)

Air Liquide America Specialty Gases, LLC, 6141 Easton Rd., P.O. Box 310, Plumsteadville, PA 18949-0310; Phone: (215) 766-8860, Fax: (215) 766-2476, [Http://www.ALSpecialtygases.com](http://www.ALSpecialtygases.com), Email: solutions.center@airliquide.com, Contact: Robert Jefferys.

Air Monitor Corp., 1050 Hopper Avenue, Santa Rosa, CA 95403; Phone: (707) 521-1703, Fax: (707) 526-2825, [Http://www.airmonitor.com](http://www.airmonitor.com), Email: pmiyaoka@airmonitor.com, Contact: Pat Miyaoka.

- § **American Crane & Equipment Corp.**, 531 Old Swede Rd., Douglassville, PA 19518; Phone: (610) 385-6061ext 224, Fax: (610) 385-3191, [Http://www.americancrane.com](http://www.americancrane.com), Email: sales@americancrane.com, Contact: Karen Norheim.
(See advertisement on page 29)
(See corporate capabilities on page 86)

American Safety Vest, 37 Eastern Ave, East Providence, RI 02914; Phone: (401) 435-0200, [Http://www.americansafetyvest.com](http://www.americansafetyvest.com), Email: madison@americansafetyvest.com, Contact: Madison Castle.

AMETEK Programmable Power Supporting Elgar Nuclear Equip., 9250 Brown Deer Rd., San Diego, CA 92121; Phone: (858) 458-0245, Fax: (858) 458-0267, [Http://www.Ametek.com](http://www.Ametek.com), Email: don.dattilo@Ametek.com, Contact: Donald P. Dattilo.

Analysis and Measurement Services Corp., AMS 9119 Cross Park Drive, Knoxville, TN 37923; Phone: 865/691-1756, Fax: 856/690-9344, [Http://www.ams-corp.com](http://www.ams-corp.com), Email: hash@ams-corp.com, Contact: H.M. Hashemian.

Andritz Maschinenfabrik AG., Statteggerstr. 18, Graz, A-8045, Austria; Phone: 43 (316)6902 402, Fax: 43 (316)6902 2513, [Http://www.andritz.com](http://www.andritz.com), Email: martin.zehentner@andritz.com, Contact: Martin Zehentner.

- § **Apantec LLC North Penn Business Park**, 4500 North Cannon Avenue, Lansdale, PA 19446; Phone: (215) 362-5343, Fax: (267) 436-4034, [Http://www.apantec.com](http://www.apantec.com), Email: bbushnell@apantec.com, Contact: Craig Mills.
(See corporate capabilities on page 86)

Applied Analysis Corp., P.O. Box 518, Reading, PA 19607; Phone: 610/775-0272, Fax: 610/777-3718, [Http://www.applied-analysis.com](http://www.applied-analysis.com), Email: jmcajigas@applied-analysis.com, Contact: Juan M. Cajiagas.

Aquilex WSI Nuclear Services, 2225 Skyland Court, Norcross, GA 30071; Phone: (678) 728-9229, [Http://www.aquilex.com/services/nuclear-service](http://www.aquilex.com/services/nuclear-service), Email: tony.papso@aquilex.com, Contact: Anthony(Tony) Papso.

- **AREVA Inc.**, 7475 Wisconsin Ave., Bethesda, MD 20814; Phone: (301) 841-2450, Fax: (434) 832-3840, [Http://www.us.aveva.com](http://www.us.aveva.com), Email: Donna GaddyBowen@aveva.com, Contact: Donna Gaddy Bowen.
(See advertisement on page 2)

Argonne National Laboratory, 9700 S. Cass Avenue/Bldg 208, Argonne, IL 60439; Phone: (630) 252-6729, Fax: (630) 252-7577, [Http://www.dd.anl.gov](http://www.dd.anl.gov), Email: lboing@anl.gov, Contact: Lawrence E Boing.

Argonne National Laboratory Vulnerability Assessment Team, 9700 S. Cass Ave, Argonne, IL 60439-4840; Phone: (630) 252-6168, Fax: (505) 665-4631, Email: rogerj@anl.gov, Contact: Roger Johnston.

- § **AT&F Nuclear, Inc Division of AT & F**, 12314 Elmwood Ave. NW, Cleveland, OH 44111; Phone: (800) 544-5316, Fax: (216) 252-4963, [Http://www.atfco.com](http://www.atfco.com), Email: cantrellk@atfco.com, Contact: Kevin Cantrell.
(See advertisement on page 8)
(See corporate capabilities on page 86)

ATC-Nuclear, 777 Emory Valley Rd., Oak Ridge, TN 37830; Phone: 865-675-5399, Fax: 865-218-8282, [Http://www.argoturbo.com](http://www.argoturbo.com), Email: rfrancis@argoturbo.com, Contact: Robert Francis.

Atlantic Nuclear Services Inc., 125 Hanwell Rd., P.O. Box 1268, Fredericton E3B 5C8, New Brunswick Canada; Phone: (506) 458-9552, Fax: (506) 451-0525, [Http://www.an-sl.ca](http://www.an-sl.ca), Email: kscott@an-sl.ca, Contact: Keith Scott.

Aware Electronics Corp., P.O. Box 4299, Wilmington, DE 19807; Phone: (302)655-3800, Fax: (302)655-3800, [Http://WWW.AW-EL.COM](http://WWW.AW-EL.COM), Email: boardmanb@aw-el.com, Contact: Bryan Boardman.

AZCO INC., 806 Valley Road, Menasha, WI 54952; Phone: (920) 734-5791, Fax: (920) 734-7432, [Http://www.azco-inc.com](http://www.azco-inc.com), Email: skennedy@azco-inc.com, Contact: Scott Kennedy.

- **AZZ / NLI**, 7410 Pebble Drive, Fort Worth, TX 76118; Phone: (800) 448-4124, [Http://www.azz.com/nli](http://www.azz.com/nli), Email: gregkeller@azz.com, Contact: Greg Keller.
(See advertisement on page 9)

Babcock Noell, Alfred-Nobel-Strasse 80, 97080 Wurzburg, Germany; Phone: 49 939 903 1439, Fax: 49 939 903 4171, [Http://www.bng.bilfinger.com](http://www.bng.bilfinger.com), Email: wolfgang.mohr@bng.bilfinger.com, Contact: Wolfgang Mohr.

Barnhart, 1901 Dunn Ave., Memphis, TN 36526; Phone: 901-775-3000, [Http://www.barnhartcrane.com](http://www.barnhartcrane.com), Email: jlatture@barnhartcrane.com, Contact: Jeff Latture.

- **Bechtel Power**, 5275 Westview Dr., Frederick, MD 21703; Phone: (301) 228-8055, Fax: (240) 379-2123, Email: ammerrim@bechtel.com, Contact: Ashley Merriman.
(See advertisement on page 33)

Bergen-Power Pipe Support, Inc, 225 Merrimac St., Woburn, MA 01801; Phone: (781)938-0026, Fax: (781)935-9550, [Http://www.bergenpower.com](http://www.bergenpower.com), Email: bpwoburn@bergenpower.com, Contact: Rich Carr.

- Bevelacqua Resources**, 343 Adair Drive, Suite 341N, Richland, WA 99352; Fax: (509)628-2240, Http://www.bevelacquaresources.com, Email: bevelresou@al.com, Contact: Bevel Joseph.
- § **BHI Energy**, 60 Industrial Park Rd., Plymouth, MA 02360; Phone: (508) 591-1149, Fax: (508) 591-1397, Http://www.bhienergy.com, Email: lauren.buckman@bhienergy.com, Contact: Lauren Buckman.
(See corporate capabilities on page 87)
- **Bigge Power Constructors**, 10700 Bigge Ave., San Leandro, CA 94577; Phone: (510) 638-8100, Fax: (510) 639-4053, Http://www.bigge.com, Email: gknopf@bigge.com, Contact: Gedge Knopf.
(See advertisement on page 99)
- § **Biodex Medical Systems, Inc.**, 20 Ramsey Road, Shirley, NY 11967; Phone: (800) 224-6339, Fax: (631) 924-9241, Http://www.biodex.com, Email: info@biodex.com, Contact: Lila Corwin.
(See corporate capabilities on page 87)
- § **BIRNS, Inc.**, 1720 Fiske Place, Oxnard, CA 93033; Phone: (805)487-5393, Fax: (805)487-0427, Http://www.birns.com, Email: service@birns.com, Contact: Eric Birns.
(See advertisement on page 51)
(See corporate capabilities on page 88)
- Black & Veatch**, 11401 Lamar Ave, Overland Park, KS 66211; Phone: (913) 458-7596, Http://www.bv.com, Email: Nurskij@bv.com, Contact: Julie Nurski.
- Blue Lake Products**, P.O. Box 16355, Irvine, CA 92623-6355; Phone: (800) 257-3477, Fax: 949/786-3108, Http://www.bluelakeproducts.com, Email: dean@bluelakeproducts.com, Contact: Dean Smeaton.
- Bureau Veritas**, 10950 S Cedar Niles Blvd., Olathe, KS 66061; Phone: (331)42 91 52 91, Fax: (331)42 91 52 90, Http://www.us.bureauverita.com, Email: Tom.Agonis@us.bureauveritas.com, Contact: Tom Agonis.
- BURNDY**, 47 East Industrial Park Drive, Manchester, New Hampshire 03109; Phone: (603) 647-5091, Http://www.burndy.com, Email: atoppazzini@burndy.com, Contact: Angela Toppazzini.
- C.J. Enterprises**, P.O. Box 570430, Tarzana, CA 91357; Phone: (818) 996-4131, Fax: (818) 708-8473, Email: cjinstruments@aol.com, Contact: Marshall Cantor.
- **Cameco Fuel Manufacturing Inc.**, 200 Dorset St. E., Port Hope, Ontario L1A 3V4 Canada; Phone: (905) 885-4537, Fax: (905) 372-3748, Http://Cameco.com, Email: Doug_Burton@Cameco.com, Contact: Doug Burton.
(See advertisement on page 81)
- § **Candu Energy Inc**, 2285 Speakman Dr., Mississauga L5K 1B1, Ontario Canada; Phone: (905) 823-9040, Fax: (905) 403-7420, Http://www.candu.com, Email: rob.adams@candu.com, Contact: Richard Moffett.
(See advertisement on page 67)
(See corporate capabilities on page 88)
- Carpency And Associates., LLC**, 13425 scottish Autumn Ln., Gaithersburg, MD 20878-3909; Phone: (301)560-1069, Fax: (301)560-4139, Http://www.carpsecurity.com, Email: fmc@carpsecurity.com, Contact: Frank M. Carpency.
- § **CartwrightDownes, Inc.**, 650 Busse Hwy, Par, IL 60068; Phone: (847)685-2727, Fax: (847)685-2702, Http://www.cartwrightdownes.com, Email: Sandy.Downes@CartwrightDownes.com, Contact: Sandy Downes.
(See corporate capabilities on page 88)
- **Ceradyne Boron Products**, 3169 Red Hill Ave, Costa Mesa, CA 92626; Phone: (714) 384-9484, Fax: (714) 675-6565, Http://www.ceradyneboron.com, Email: pbass@ceradyne.com, Contact: Patti Bass.
(See advertisement on page 58)
- CHAMPS Software, Inc.**, 1255 N. Vantage Point Drive, Crystal River, FL 34429-8370; Phone: (352)795-2362 x226, Fax: (352)795-9100, Http://www.champsinc.com, Email: mmelfi@champsinc.com, Contact: Mike Melfi.
- **Chatham Steel Corporation**, 501 W. Boundary, Savannah, GA 31401; Phone: (800) 869-2762, Fax: (919) 682-0322, Http://www.chathamsteel.com, Email: nuclear@chathamsteel.com, Contact: Chris White.
(See advertisement on page 73)
- Chemetrics, Inc.**, 4295 Catlett Rd., Midland, VA 22728; Phone: (540) 788-9026, X127, Fax: (540) 788-4856, Http://www.chemetrics.com, Email: bhruska@chemetrics.com, Contact: Bob Hruska.
- Collier Associates, Inc.**, 235 Ridgewood Drive, Mystic, CT 06355-2029; Phone: (860) 536-9538, Fax: (860) 572-8439, Http://http://www.gwcollier.com, Email: cai@gwcollier.com, Contact: George W. Collier.
- Conco Systems, Inc.**, 530 Jones St., Verona, PA 15147; Phone: (800) 345-3476, Fax: (412) 826-3336, Http://www.concosystems.com, Email: info@concosystems.com, Contact: Jennifer Larson.
- Conger & Elsea, Inc.**, 9870 Hwy. 92, Ste. 300, Woodstock, GA 30188; Phone: (800) 875-8709, Fax: (770) 926-8305, Http://www.conger-elsea.com, Email: dorian.conger@conger-elsea.com, Contact: Dorian Conger.
- Container Products Corporation**, 112 N. College Rd., P.O. Box 3767, Wilmington, NC 28405; Phone: (910) 392-6100, Fax: (910) 392-6778, Http://www.c-p-c.com, Email: sales@c-p-c.com, Contact: Ken Beyma.
- Conval Inc.**, 265 Field Rd., Somers, CT 06071; Phone: (860) 763-3551, Fax: (860) 763-3557, Http://www.conval.com, Email: mhendrick@conval.com, Contact: Michael Hendrick.
- **Copes-Vulcan,SPX Brand**, 5620 West Road, McKean, PA 16426; Phone: (814) 476-5800, Fax: (814) 476-5854, Http://www.spx.com/en/copes-vulcan/, Email: copesvulcan@spx.com, Contact: David Martin.
(See advertisement on page 83)
- CORE, Inc.**, 5915 Braun Way, Arvada, CO 80004; Phone: (303) 425-7408, Fax: (303) 425-0861, Http://www.pmooptimization.com, Email: jkaugust@msn.com, Contact: J.K. August.
- Corrosion Control Services, Inc. CCSI Engineered Diaphragm Div**, 324 Scott St., Davenport, IA 528081; Phone: (563) 324-9076, Fax: (563) 324-9077, Http://www.corrosioncontrolservice.com, Email: ccsi@corrosioncontrolservice.com, Contact: Ronald Frantz.
- Croll-Reynolds Engineering Company Inc.**, 2400 Reservoir Ave., Trumbull, CT 06611-4735; Phone: (203) 371-1983, Fax: (203) 371-0615, Http://www.croll-reynoldsengeering.com, Email: creco@att.net, Contact: L.D. Ancillai.
- CTR Technical Services, Inc.**, 950 Sugarloaf Rd., Manitou Springs, CO 80829; Phone: (800) 524-9328, Fax: (719) 685-3579, Http://www.ctr-tech.com, Email: ctr@ctr-tech.com, Contact: Charles T. Rombough.
- Curtiss-Wright Flow Control Company**, 2950 Birch Street, Brea, CA 92821; Phone: (714) 528-2301, x240, Fax: (714) 528-0128, Http://www.curtisswright.com, Email: acorkhill@curtisswright.com, Contact: Arlene Corkhill.
- Cutsforth**, 5493 Waschke Road, Bellingham, WA 98226; Phone: (800)290-6458x29, Fax: (800)398-6561, Http://www.cutsforth.com, Email: sthompson@cutsforth.com, Contact: Steve Thompson.
- § **Cutting Edge Services Corporation**, 1535 Old SR 74, Batavia, OH 45103; Phone: (513) 388-0199, Fax: (513) 732-1248, Http://www.cuttingedgeservices.com, Email: beckman@cuttingedgeservices.com, Contact: Timothy Beckman.
(See corporate capabilities on page 88)

Cutting Technologies, 101 Washington Ave., Gloucester City, NJ 08030; Phone: (856) 456-2255, Fax: (856) 456-8070, [Http://www.cuttingtechnologies.com](http://www.cuttingtechnologies.com), Email: sales@cuttingtechnologies.com, Contact: Jay Faith.

DADE Moeller & Associated, Inc., 1835 Terminal Dr., suite 200, Richland, WA 99354; Phone: (509)942-3639, Fax: (509)946-4412, [Http://www.moellerinc.com](http://www.moellerinc.com), Email: sbump@moellerinc.com, Contact: Stephen Bump.

- **Day & Zimmermann ECM**, 1500 Spring Garden St 10th Floor, Philadelphia, PA 19130; Phone: (215) 299-4924, Fax: (215) 299-8395, [Http://www.dayzim.com](http://www.dayzim.com), Email: david.bronczyk@dayzim.com, Contact: David A. Bronczyk.
(See advertisement on page 53)

DCS Systems Inc., 12 Oakwood Road, Simsbury, CT 06070-2123; Phone: (860)651-0218, Fax: (860)651-0219, Email: gddooley@dcssystems.com, Contact: George D. Dooley.

Del Mar Avionics, 1601 Alton Parkway, Suite C, Irvine, CA 92606; Phone: (949) 250-3200, Fax: (949) 261-0529, [Http://www.dma.com](http://www.dma.com), Email: delmarav@dma.com, Contact: Jack Hammond.

Delta M Corporation, 1003 Larsen Dr., Oak Ridge, TN 37830; Phone: (865) 483-1569 ext 120, Fax: (865) 483-1142, [Http://www.deltamcorp.com](http://www.deltamcorp.com), Email: awhite@deltamcorp.com, Contact: A. D. White.

Design Engineering Analysis Corporation, 335 Morganza Rd., Canonsburg, PA 15317; Phone: (724) 743-3322, Fax: (724) 743-0934, [Http://www.deac.com](http://www.deac.com), Email: info@deac.com, Contact: George J. Hrico.

- **Diakont**, 3821 Calle Fortunada, San Diego, CA 92123; Phone: (858) 551-5551, Fax: (858) 504-7065, [Http://www.diakont.com](http://www.diakont.com), Email: support@diakont.us.com, Contact: Aaron Huber.
(See advertisement on page 4)

§ **Diversified Technologies Services, Inc.**, 2680 Westcott Boulevard, Knoxville, TN 37931; Phone: (865) 539-9000, Fax: (865) 539-9001, [Http://www.dts9000.com](http://www.dts9000.com), Email: info@dts9000.com, Contact: Charles Jensen.
(See corporate capabilities on page 88)

Draeger Safety, Inc., 101 Technology Dr., Pittsburgh, PA 15275; Phone: (412) 787-8383, Fax: (412) 787-2207, [Http://www.draeger.com](http://www.draeger.com), Email: prodinfo@draeger.com, Contact: Shelli Cosmides.

§ **DRS Consolidated Controls, Inc.**, 21 South Street, Danbury, CT 06810; Phone: (203) 798-3030, Fax: (203) 798-3214, [Http://www.drs-cci.com](http://www.drs-cci.com), Email: sales@drs-cci.com, Contact: Andrew Gaunt.
(See corporate capabilities on page 88)

§ **Dufrane Nuclear Shielding, Inc.**, 125 Price Road, Winsted, CT 06098; Phone: (860) 379-2318, Fax: (860) 379-2325, [Http://www.dufrane.com](http://www.dufrane.com), Email: support@dufrane.com, Contact: Louis DeRitis.
(See corporate capabilities on page 88)

Dynasil Products, 44 Hunt Street, Watertown, MA 02472; Phone: (617) 668-6900, Fax: (617) 926-9743, [Http://www.DynasilProducts.com](http://www.DynasilProducts.com), Email: pwaer@dynasilproducts.com, Contact: Peter Waer.

§ **E.H. Wachs**, 600 Knightsbridge Pkwy., Lincolnshire, IL 60069; Phone: (800) 323-8185, Fax: (847) 520-1147, [Http://www.ehwachs.com](http://www.ehwachs.com), Email: info@ehwachs.com, Contact: Keith Polifka.
(See corporate capabilities on page 88)

Eberline Services Inc., 7021 Pan American Freeway NE, Albuquerque, NM 87109; Phone: (505) 262-2694, Fax: (505) 262-2698, [Http://www.eberlineservices.com](http://www.eberlineservices.com), Email: vybarra@eberlineservices.com, Contact: Veronica Ybarra.

Elan Technical Corporation, 141 Kings Hwy. E, Fairfield, CT 06825; Phone: (203) 335-2115, Fax: (203) 335-2723, [Http://www.elantechnical.com](http://www.elantechnical.com), Email: elantechnical@sbcglobal.net, Contact: Randolph Bush.

- § **Ellis & Watts Global Industries, LLC.**, 4400 Glen Willow Lake Ln., Batavia, OH 45103; Phone: (513) 752-9000, Fax: (513) 752-4545, [Http://www.elliswatts.com](http://www.elliswatts.com), Email: jmenkhaus@elliswatts.com, Contact: Joseph J. Menkhaus.
(See advertisement on page 47)
(See corporate capabilities on page 89)

Emerson Process Management, 301 South 1st Ave., Marshalltown, IA 50158; Phone: (641) 754-3288, Fax: (641) 754-2731, [Http://www.fisher.com](http://www.fisher.com), Email: john.wells@emerson.com, Contact: John Wells.

Energy Resources Group, Inc., 23 Commerce Park Way, Farmington, NH 03835; Phone: (603) 355-2535, Fax: (603) 355-2539, Email: ergincorp@aol.com, Contact: A.J. Maggio.

- **Energy Steel & Supply CO.**, 3123 John Conley Drive, Lapeer, MI 48446; Phone: 810/538-4990, Fax: 810/538-4940, [Http://www.energysteel.com](http://www.energysteel.com), Email: wwaters@energysteel.com, Contact: Waylon Waters.
(See advertisement on page 13)

Energysys, 2366 Bernville Rd., Reading, PA 18605; Phone: (610)208-1746, Fax: (610)372-8698, [Http://www.energysys.com](http://www.energysys.com), Email: george.brendahl@energysys.com, Contact: George Brendahl.

Enertech, a business unit of Curtiss-Wright Flow Control Company, 2950 Birch St., Brea, CA 92821; Phone: (714) 528-2301, Fax: (714) 528-0128, [Http://www.enertechnuclear.com](http://www.enertechnuclear.com), Email: christinea@curtisswright.com, Contact: Christine Anderson.

Engineering Mechanics Corporation of Columbus, 3518 Riverside Dr, Suite 202, Columbus, Ohio 43221-1735; Phone: (614) 459-3200x224, Fax: (614) 459-6800, [Http://www.emc-sq.com](http://www.emc-sq.com), Email: gattery@emc-sq.com, Contact: Gary Hattery.

ENMET Corporation, 680 Fairfield Court, P.O. Box 979, Ann Arbor, MI 48106; Phone: (734) 761-1270, Fax: (734) 761-3220, [Http://www.enmet.com](http://www.enmet.com), Email: info@enmet.com, Contact: Nancy Aulisa.

ENVINET GmbH, Hans-Pinsel-Str.4, 85540 Haar, Germany; Phone: (49) 89 456657 0, Fax: (49) 89 456657 820, [Http://www.technidata.de](http://www.technidata.de), Email: Claus.Holzheimer@technidata.de, Contact: Claus Holzheimer.

EPM, Inc, 959 Concord St., Framingham, MA 01701; Phone: 508-875-2121 X239, Fax: 508-879-3291, [Http://www.epm-inc.com](http://www.epm-inc.com), Email: rbk@epm-inc.com, Contact: Robert Kalantari.

- **EST Group, a business unit of Curtiss-Wright Flow Control Company**, 2701 Township Line Road, Hatfield, PA 19440; Phone: (800) 355-7044, Fax: (215) 721-1101, [Http://www.estgrp.cwfc.com](http://www.estgrp.cwfc.com), Email: jmarengo@curtisswright.com, Contact: James Marengo.
(See advertisement on page 116)

Euclid Garment Manufacturing Company, 333 Martinel Dr. P.O. Box 550, Kent, OH 44240-0550; Phone: (330) 673-7413, Fax: (330) 673-0228, [Http://www.euclidgarment.com](http://www.euclidgarment.com), Email: hfleischmann@euclidgarment.com, Contact: Howard FleischmannQZ.

§ **Excel Modular Scaffold & Leasing Corporation**, 17900 Excel Blvd, Walker, LA 70785; Phone: (860) 873-9987, Fax: (860) 873-1753, [Http://www.excelscaffold.com](http://www.excelscaffold.com), Email: jim.elkins@excelscaffold.com, Contact: James E. Elkins.
(See corporate capabilities on page 89)

F+J Specialty Products, Inc., 404 Cypress Road, Ocala, FL 34472; Phone: (352) 680-1177, Fax: (352) 680-1454, [Http://www.fjspecialty.com](http://www.fjspecialty.com), Email: fandj@fjspecialty.com, Contact: Jorge Bel Tran.

- **Fairbanks Morse Engine**, 701 White Ave., Beloit, WI 53511; Phone: (608) 364-8005, Fax: (608) 365-6955, [Http://www.fairbanksmorsenuclear.com](http://www.fairbanksmorsenuclear.com), Email: kevin.lidbury@fairbanksmorse.com, Contact: Kevin Lidbury.
(See advertisement on page 35)

- **Fauske & Associates., LLC**, 16W070 83rd Street, Burr Ridge, IL 60527; Phone: (630) 887-5285, Fax: (630) 986-5481, [Http://www.fauske.com](http://www.fauske.com), Email: rlee@fauske.com, Contact: Russell Lee. (See advertisement on page 22)
- Flowserve Engineered Products Division**, 2801 Hutchinson McDonald Road, SuiteT, Charlotte, NC 28269; Phone: (952)443-0682, [Http://www.flowserve.com](http://www.flowserve.com), Email: jcook@flowserve.com, Contact: Jim Cook.
- Flowserve Flow Control Division**, 1900 South Saunders Street, Raleigh, NC 27603; Phone: (919) 831-3200, Fax: (919) 831-3317, [Http://www.flowserve.com](http://www.flowserve.com), Email: fbensinger@flowserve.com, Contact: Floyd Bensinger.
- § **Fluid Components International (FCI)**, 1755 La Costa Meadows Dr., San Marcos, CA 92078; Phone: (760) 736-6125, Fax: (760) 736-6250, [Http://www.fluidcomponents.com](http://www.fluidcomponents.com), Email: nuclear@fluidcomponents.com, Contact: Kenneth Christian. (See corporate capabilities on page 89)
- **Frham Safety Products, Inc.**, 318 Hill Ave., P.O. Box 101177, Nashville, TN 37224; Phone: (615) 254-0841, Fax: (615) 726-2514, [Http://www.frhamsafety.com](http://www.frhamsafety.com), Email: mrandall@frhamsafety.com, Contact: Michael Randall. (See advertisement on page 19)
- **Frontier Technology Corporation**, 1641 Burnett Dr., Xenia, OH 45385; Phone: (937) 376-5691, Fax: (937) 376-5692, [Http://www.frontier-cf252.com](http://www.frontier-cf252.com), Email: trevalj@juno.com, Contact: Treva Janzow. (See advertisement on page 71)
- Fuel Tank Maintenance Company LLC**, 240 Mill Dr, Cookeville, TN 38501; Phone: (931) 528-1137, Fax: (931) 520-3862, [Http://www.fueltankmaintenance.com](http://www.fueltankmaintenance.com), Email: jthahnjr@hotmail.com, Contact: Jerry T. Hahn.
- Fusion Babbiting Co. Inc.**, 4540 W. Burnham St, Milwaukee, WI 53219; Phone: (414)645-6606, Fax: (414)645-5800, [Http://www.fusionbabbiting.com](http://www.fusionbabbiting.com), Email: markmckind@yahoo.com, Contact: Mark McKindley.
- § **G.D. Barri & Associates, Inc.**, 6860 W. Peoria Ave., Peoria, AZ 85345; Phone: (623) 773-4010, Fax: (623) 773-2924, [Http://www.gdbarri.com](http://www.gdbarri.com), Email: georgia.barri@gdbarri.com, Contact: Georgia D. Barri. (See advertisement on page 72) (See corporate capabilities on page 89)
- Gammasonics Institute for Medical Research**, 90 Queens Rd., Five Dock NSW, Australia; Phone: (+61) 2 97130000, [Http://www.gammasonics.com](http://www.gammasonics.com), Email: enquiries@gammasonics.com, Contact: Simon Biton.
- **GE Hitachi Nuclear Energy**, 3901 Castle Hayne Rd., PO Box 780 M/C A66, Wilmington, NC 28402; Phone: (910) 819-1927, Fax: (910) 675-5549, [Http://www.ge-energy.com/nuclear](http://www.ge-energy.com/nuclear), Email: julia.longfellow@ge.com, Contact: Julia Longfellow. (See advertisements on page 25 and 59)
- GEL Engineering LLC**, 2040 Savage Road, Charleston, SC 29407; Phone: (843)769-7378, Fax: (843)769-7397, [Http://www.gel.com](http://www.gel.com), Email: james.posda@gel.com, Contact: Jim Posda.
- § **General Cable**, 4 Tessenner Drive, Highland Heights, KY 41076; Phone: (859) 572-8664, Fax: (860) 465-8869, [Http://www.GeneralCable.com](http://www.GeneralCable.com), Email: jpace@GeneralCable.com, Contact: Jason Pace. (See corporate capabilities on page 89)
- § **Golder Associates Ltd.**, 6925 Century Avenue, Suite, 100, Mississauga, ON L5N 7K2 Canada; Phone: (905) 567-4444, Fax: (905) 567-6561, [Http://www.golder.com](http://www.golder.com), Email: George_Schneider@golder.com, Contact: George Schneider. (See corporate capabilities on page 89)
- Greenberry Fabrication**, 600 SE Maritime Ave, Suite 190, Vancouver, WA 98661; Phone: (360) 567-0006, [Http://www.greenberry.com](http://www.greenberry.com), Email: mstapleton@greenberry.com, Contact: Mark Stapleton.
- GUTOR Electronic LLC**, Hardstrasse 74, CH-5430 Wettingem, Switzerland Phone: (636) 294-5198, Fax: (636) 294-5198, [Http://www.gutor.com](http://www.gutor.com), Email: tom.stomerski@schneider-electric.com, Contact: Thomas Stomerski.
- Hake Rigging Company**, 10 IND. Hwy ms-81, B-Complex A-Aisle, Lester, PA 19029; Phone: (610) 499-1790, Fax: (610) 499-1796, [Http://hakerigging.com](http://hakerigging.com), Email: adesper@hakerigging.com, Contact: Allen Wenturine.
- Health Physics Instruments Div. of Far West Technology**, 330 S. Kellogg Ave., Suite D, Goleta, CA 93117-3814; Phone: (805) 964-3615, Fax: (805) 964-3162, [Http://www.fwt.com](http://www.fwt.com), Email: info@fwt.com, Contact: John Handloser.
- Heat Exchanger Products Corp.**, 55 Industrial Park Road, Hingham, MA 02043; Phone: (781) 749-0220, Fax: (781) 740-8738, [Http://www.hepcoplugs.com](http://www.hepcoplugs.com), Email: hepcoplugs@hepcoplugs.com, Contact: Tracy Hennigan Bonnyman.
- Henry Pratt Company**, Sub. of Mueller Co., 401 S. Highland Ave., Aurora, IL 60506; Phone: (630) 844-4000, Fax: (630) 844-4160, [Http://www.henrypratt.com](http://www.henrypratt.com), Email: marketing@henrypratt.com, Contact: ED Schutz.
- Herculite Products**, P.O. Box 435, Emigsville, PA 17318; Phone: (717) 764-1192, Fax: (717) 764-5211, [Http://www.herculite.com](http://www.herculite.com), Email: customercare@herculite.com, Contact: Customer Service.
- § **Herguth Laboratories**, 101 Corporate Place, Vallejo, CA 94590; Phone: (800) 645-5227, Fax: (707) 554-0109, [Http://www.herguth.com](http://www.herguth.com), Email: lperry@herguth.com, Contact: Linda Perry. (See advertisement on page 50) (See corporate capabilities on page 89)
- **HF Controls**, 1624 W. Crosby Rd., Carrollton, TX 75006; Phone: (214) 809-9546, Fax: (469) 568-6589, [Http://HFcontrols.com](http://HFcontrols.com), Email: robert.contrato@doosan.com, Contact: Robert Contratto. (See advertisement on page 3)
- § **HI-Q Environmental Products Company**, 7386 Trade ST, San Diego, CA 92121-2422; Phone: (858) 549-2820, Fax: (858) 549-9657, [Http://www.HI-Q.net](http://www.HI-Q.net), Email: info@HI-Q.net, Contact: Marc Held. (See advertisement on page 41) (See corporate capabilities on page 90)
- Holtec International**, 555 Lincoln Dr. W, Marlton, NJ 08053; Phone: (856) 797-0900, X655, Fax: (856) 797-0909, [Http://www.holtecinternational.com](http://www.holtecinternational.com), Email: joy_russell@holtec.com, Contact: Joy Russell.
- Hopewell Designs, Inc.**, 5940 Gateway Dr., Alpharetta, GA 30004; Phone: (770)667-5770, Fax: (770)667-7539, [Http://www.hopewelldesigns.com](http://www.hopewelldesigns.com), Email: jgarrett@hopewelldesigns.com, Contact: Joy Garrett.
- Howard L. Sobel, P.E.**, 3061 David Court, Oceanside, NY 11572; Phone: (516)536-0199, Fax: (516)536-7691, Email: HLSOBELPE@AOL.COM, Contact: Howard L. Sobel.
- HSB Global Standards**, One State Street, Hartford, CT 06103; Phone: (860) 722-5041, [Http://www.hsbglobalstandards.com](http://www.hsbglobalstandards.com), Email: nuclear_services@hsbet.com, Contact: Stephen Mckelucy.
- § **HukariAscendent**, 4251 Kipling Street, Suite 580, Wheat Ridge, Colorado 80033; Phone: (303) 384-9079, Fax: (303) 277-1458, [Http://www.hukari.com](http://www.hukari.com), Email: Robertp@hukari.com, Contact: Robert Plappert. (See advertisement on page 12) (See corporate capabilities on page 90)
- Human and Organizational Performance Improvement**, 7030 North 175th Avenue, Waddell, AZ 85355; Phone: (602) 908-0684, Email: hopiconsulting@msn.com, Contact: Michael Salazar.
- Hurst Technologies Corp.**, 4005 Technology Drive, P.O. Box 1718, Angleton, TX 77515; Phone: (979)849-5068, Fax: (979)848-8091, [Http://www.hursttech.com](http://www.hursttech.com), Email: timh@hursttech.com, Contact: Timothy E. Hurst.

Hydratight, 5001 Moundview Dr., Red Wing, MN 55066; Phone: (651) 388-8661, Fax: (651) 388-0002, Http://www.hydratight.com, Email: redwing@hydratight.com, Contact: Bob Boychuk.

IHI Transport Machinery Co., Ltd., 8-1 Akashicho, Chuo-ku, Tokyo 1040044, Japan Phone: (+81) 3-5550-5375, Fax: (+81) 3-5550-5376, Http://www.iuk.co.jp, Email: masao.akamatsu@iuk.co.jp, Contact: Masao Akamatsu.

§ **ILD, Inc.**, 8867 Highland Rd., #378, Baton Rouge, LA 70808; Phone: (225) 769-2780, Fax: (225) 769-2751, Http://www.ildpower.com, Email: jack@ildpower.com, Contact: Jack Little. (See corporate capabilities on page 90)

Interdevelopment, Inc., P.O. Box 15249, Arlington, VA 22215; Phone: (202) 508-1459, Fax: (202) 337-3159, Http://www.interdevelopment.com, Email: interdevelopment@starpower.net, Contact: Margareta. K. Luddemann-Faris.

International Plastics, Inc., 185 Commerce Center, Greenville, SC 29615-9527; Phone: (864) 297-8000, Fax: (864) 297-7186, Http://www.interplas.com, Email: steve@interplas.com, Contact: Steve McClure.

International Quality Consultants, Inc., 106 Freeport Rd., Butler, PA 16002; Phone: (724) 284-3738, Fax: (724) 284-1310, Http://www.iqconconsulting.com, Email: tepaserba@iqconconsulting.com, Contact: Thomas E. Paserba.

Ionex Research Corp., P.O. Box 70, 1301 Eastwind Dr., Lafayette, CO 80026; Phone: (303) 666-5550, Fax: (303) 666-5560, Http://www.ionexres.com, Email: dporrey@ionexres.com, Contact: Douglas W. Porrey.

§ **iRobot Corporation**, 8 Crosby Drive, Bedford, MA 01730; Phone: (781) 430-3000 X 5044, Http://www.irobot.com, Email: kmonti@irobot.com, Contact: Kim Monti.

(See corporate capabilities on page 90)

ITT Veam LLC, 100 New Wood Rd., Watertown, CT 06795-3347; Phone: (860) 945-8228, Fax: (860) 274-4963, Email: douglas.merriman@itt.com, Contact: Douglas A. Merriman.

Jacox Associates, 4471 Summit Rd., Pataskala, OH 43062; Phone: (740) 964-3683, Email: jwrj@columbus.rr.com, Contact: Jack Jacox.

§ **James C. White Company**, 10 Halton Road, Greenville, SC 29607; Phone: (864) 288-3102, Fax: (864) 288-3643, Http://www.JCWCO.com, Email: nuclearsales@JCWCO.com, Contact: John Detandt. (See corporate capabilities on page 90)

Jonas, Inc., 4313 Nebraska Court, Pomfret, MD 20675; Phone: (301) 934-5605, Fax: (301) 934-5606, Http://www.steamcycle.com, Email: jonasinc@steamcycle.com, Contact: Lee Machemer.

• § **Joseph Oat Corporation**, 2500 Broadway, Camden, NJ 08104; Phone: (856) 541-2900 x205, Fax: (856) 541-0864, Http://www.josephoat.com, Email: mcdonaldj@josephoat.com, Contact: John McDonald.

(See advertisement on page 37)
(See corporate capabilities on page 90)

JRM Chemical, Inc., 4881 Neo Pkwy., Cleveland, OH 44128; Phone: (800) 962-4010, Fax: (216) 475-6517, Http://www.soilmoist.com, Email: jrm@en.com, Contact: David Czehut.

• § **Kinectrics Incorporated**, 800 Kipling Avenue, Unit 2, Toronto, Ontario, M8Z 6C4 Canada; Phone: (416) 207-6000, Fax: (416) 207-6532, Http://www.kinectrics.com, Email: cheryl.tasker-shaw@kinectrics.com, Contact: Cheryl Tasker-Shaw.

(See advertisement on page 7)
(See corporate capabilities on page 91)

Konecranes Nuclear Equipment & Services LLC, 126 Powerline Road, Boyertown, PA 19512; Phone: (610) 368-8389, Fax: (610) 689-4810, Http://www.morriscranes.com, Email: davidschaeffer@konecranes.com, Contact: David Schaeffer.

KURION, INC, 2040 Main Street, Suite 800, Irvine, CA 92614-8257; Phone: (949) 398-8344, Fax: (949) 682-7028, Http://www.kurion.com, Email: jraymont@kurion.com, Contact: John Raymont.

Laboratory Services, 135 W. Trail St., Jackson, MI 49201; Phone: (800) 736-4147, Fax: (517) 788-1104, Http://www.laboratoryservices.com, Email: naserafin@cmsenergy.com, Contact: Nick Serafin.

§ **Laboratory Testing Inc.**, 2331 Topaz Drive, Hatfield, PA 19440; Phone: (800) 219-9095, Fax: (800) 219-9096, Http://www.labtesting.com, Email: sales@labtesting.com, Contact: Rick Heist.

(See corporate capabilities on page 91)

LANCS Industries Holdings, LLC., 12704 NE 124th St., #36, Kirkland, WA 98034; Phone: (425) 823-6634, Fax: (425) 820-6784, Http://www.lancsindustries.com, Email: sales@lancsindustries.com, Contact: Lewis Byrd.

Lightbridge Corporation, 1600 Tysons Blvd. Ste 550, McLean, VA 22102; Phone: (571) 730-1200, Fax: (571) 730-1260, Http://www.ltbridge.com, Email: jbaggett@ltbridge.com, Contact: Jonathan Baggett.

Lights, Camera, Action LLC, 1035 N McQueen Rd, Ste 103, Gilbert, AZ 85233-2334; Phone: (480) 345-0642, Fax: (480) 345-0644, Http://www.lights-camera-action.net, Email: sales@lights-camera-action.net, Contact: Walt Ahland.

Lincoln Structural Solutions (LSS Nuclear), 11005 E Circle, Omaha, NE 68137; Phone: (678) 588-8895, Fax: (402) 504-4782, Http://www.lssnuclear.com, Email: gsnyder@lssnuclear.com, Contact: Garry Snyder.

Linn High Therm GmbH, Heinrich-Hertz-Platz 1, 92275 EschenPelden, Germany; Phone: (499) 66591400, Fax: (499) 6651720, Http://www.linn.de, Email: info@linn.de, Contact: Horst Linn.

Lisega Inc. (Sub. of Lisega AG), 370 E. Dumplin Valley Rd., Kodak, TN 37764; Phone: (865) 940-5311, Fax: (865) 940-5140, Http://www.lisega.com, Email: fandetti-nuc@lisega.com, Contact: Robert Fandetti.

LISEGA SE, Hochkamp 5, Zeven 27404, Lower Saxony, Germany; Http://www.lisega.com, Email: Harald.Lange@de.lisega.com, Contact: Harald Lange.

Lonza Wood Protection, 5660 New Northside Dr, Suite 1100, Atlanta, GA 30328; Phone: (678) 627-2215, Fax: (678) 627-2095, Http://www.useFRTW.com, Email: huck.devenzio@lonza.com, Contact: Huck DeVenzio.

Ludeca Inc., 1425 N. W. 88th Avenue, Doral, FL 33172; Phone: (305)591-8935, Fax: (305)591-1537, Http://www.ludeca.com, Email: info@ludeca.com, Contact: Nils Heilemann.

Lytron, 55 Dragon Ct., Woburn, MA 01801; Phone: (781) 933-7300, Fax: (781) 935-4529, Http://www.lytron.com, Email: info@lytron.com, Contact: Tracey Barber.

M+P Lab, 2210 Technology Dr., Schenectady, NY 12308; Phone: (518) 382-0082, Fax: (518) 382-1182, Http://www.the-mandp-lab.com, Email: info@the-mandp-lab.com, Contact: Mary Ann Arcesi.

MarShield Div. of Mars Metal Company, 4140 Morris Drive, Burlington L7L 5L6, Ontario, Canada Phone: (800) 381-5335, Fax: (905) 637-8841, Http://www.marshield.com, Email: dholden@marsmetal.com, Contact: David Holden.

Mass Spec Services, 103 S. Greenbush Road, Orangeburg, NY 10962; Phone: (845) 359-1151, Fax: (845) 359-1102, Email: georock150@aol.com, Contact: Keith Noyes.

McNichols Company, P.O. Box 30300, Tampa, FL 33630-3300; Phone: (800) 237-3820, Fax: (813) 288-1828, Http://www.mcnichols.com, Email: sales@mcnichols.com, Contact: Sharon Robertson.

Mechanical Equipment Company, 1301 Industrial Drive, Matthews, NC 28105; Phone: (704) 847-2100, Fax: (704) 847-2349, Http://www.mechequip.com, Email: cparnell@mechequip.com, Contact: Chuck Parnell.

- § **Mirion Technologies**, Bishop Ranch 8, 3000 Executive Parkway Suite 220, San Ramon, CA 94583; Phone: (925) 543-0800, Fax: (925) 543-0808, Http://www.mirion.com, Email: info@mirion.com, Contact: Kimberly Croxson.
(See advertisement on page 17)
(See corporate capabilities on page 91)
- **Mohawk Industrial & Nuclear Supply, Inc.**, 5 Glen Road, Manchester, CT 06040; Phone: (860) 643-5107, Fax: (860) 646-6209, Http://www.mohawksafety.com, Email: sales@mohawksafety.com, Contact: Jim Francoline.
(See advertisement on page 44)

§ **Mott Corporation**, 84 Spring Ln., Farmington, CT 06032-3159; Phone: (860) 747-6333, Fax: (860) 747-6739, Http://www.mottcorp.com, Email: QUEST@mottcorp.com, Contact: Patty Dillon.
(See corporate capabilities on page 92)

Murray and Trettel, Inc., 600 First Bank Drive, Palatine, IL 60067; Phone: (847) 963-9000, X130, Fax: (847) 963-0199, Http://www.weathercommand.com, Email: mark.carroll@weathercommand.com, Contact: Mark Carroll.

Nameco Controls, 2100 West Broad Street, Elizabethtown, NC 28337; Phone: (910)879-5820, Fax: (910)879-5486, Http://www.danaherspecialtyproducts.com, Email: dcoe@dancon.com, Contact: Douglas Coe.

National Inspection & Consultants, LLC., 9911 Bavaria Rd., Fort Myers, FL 33913; Phone: (239) 939-4313, Fax: (239) 334-8777, Http://www.nicinc.com, Email: dave.vigne@nicinc.com, Contact: David Vigne.

New World Utility Services, 505 Avaron Rd, Thomaston, GA 30286; Phone: (706) 601-3477, Fax: (706) 601-3477, Email: lfc1426@gmail.com, Contact: Lee Clark.

Newage Industries, Inc., 145 James Way, Southampton, PA 18966; Phone: (215) 526-2300, Fax: (215) 526-2190, Http://www.newageindustries.com, Email: psales@newageindustries.com, Contact: Sales Team.

nexArc Inc., 2606 B Short Rd., Millville, PA 17846; Phone: (570) 458-6990, Fax: 888-853-6954, Http://www.nexarc.us, Email: rlaubach@nexarc.us, Contact: Rick Laubach.

Niagara Fasteners Inc., 6095 Progress St., Niagara Falls L2E 6S8, Ontario Canada; Phone: (800) 263-3602, Fax: (905) 356-5747, Http://www.niagarafasteners.com, Email: tneal@niagara.com, Contact: Ted Neal.

Novatech, 220 Jefferson Ridge Pkwy., Lynchburg, VA 24501; Phone: 434/239-1979, Fax: 434/239-6232, Http://www.novatechusa.com, Email: novatech@novatechusa.com, Contact: Simon Hitchcock.

NPTS, Inc., 2060 Sheridan Dr., Buffalo, NY 14223-1470; Phone: (716) 876-8066, Fax: (716) 876-8004, Http://www.npts.net, Email: npts@eiteam.com, Contact: Hormoz Mansouri.

NSSI/Recovery Services Inc., P.O. Box 34042, Houston, TX 77234; Phone: (713) 641-0391, Fax: (713) 641-6153, Http://www.nssihouston.com, Email: rdgallagher@nssihouston.com, Contact: Robert Gallagher.

Nuclear Shielding Supplies & Service, 4620 S. Coach Dr., Tucson, AZ 85714-1942; Phone: (520) 917-0661, Fax: (520) 917-0664, Http://www.nuclearshielding.com, Email: info@nuclearshielding.com, Contact: Jordy Ensio.

- **NUCON International, Inc.**, 7000 Huntley Rd., Columbus, OH 43229; Phone: (614) 846-5710, X115, Fax: (614) 431-0858, Http://www.nucon-int.com, Email: curt.graves@nucon-int.com, Contact: Curtis Graves.
(See advertisement on page 23)
- **Nutherm International, Inc.**, 501 South Eleventh Street, Mount Vernon, IL 62864-4834; Phone: (618) 244-6000, Fax: (618) 244-6641, Http://www.nutherm.com, Email: sales@nutherm.com, Contact: Stan Stack.

- § **Oregon Iron Works, Inc**, 9700 SE Lawnfield Road, Clackamas, OR 97015; Phone: (503) 653-6300, Fax: (503) 653-5870, Http://www.oregoniron.com, Email: sales@oregoniron.com, Contact: Bradley Dunkin.
(See advertisement on page 27)
(See corporate capabilities on page 92)

ORTEC, 801 S. Illinois Ave., Oak Ridge, TN 37831; Phone: (865) 483-2124, Fax: (865) 425-7380, Http://www.ortec-online.com, Email: susie.brockman@ametec.com, Contact: Susie Brockman.

Pacific Radiation Corporation, 2945 Stonehill Dr., Altadena, CA 91001; Phone: (626) 798-8100, Fax: (626) 798-8100, Http://www.pacificrad.com, Email: dr_dan@pacificrad.com, Contact: Dan Gollnick.

§ **PaR Systems, Inc.**, 707 County Road E W, Shoreview, MN 55126; Phone: (651) 484-7261, Fax: (651) 483-2689, Http://www.par.com, Email: info@par.com, Contact: Karen Knoblock.
(See corporate capabilities on page 93)

PaR-KUT, 899 Highway 96 W, Shoreview, MN 55126; Phone: (651) 415-4366, Fax: (651) 415-4500, Http://www.parnuclear.com, Email: schulzjs@westinghouse.com, Contact: Jason Schulz.

Par-Kut International, Inc., 40961 Production Drive, Harrison Twp, MI 48045-1351; Phone: (586)468-2947, Fax: (586)463-6059, Http://www.parkut.com, Email: sales@parkut.com, Contact: Tom Duemling.

Pawling Engineered Products, 157 Charles Colman Blvd., Pawling, NY 12564; Phone: (845) 855-1000, Fax: (845) 855-1139, Http://www.pawlingepd.com, Email: cbusby@pawling.com, Contact: Craig Busby.

§ **Peerless Electric**, 1401 West Market Street, Warren, OH 44485-2797; Phone: (800) 676-3651, Fax: (330) 393-6041, Http://www.peerlesselectric.com, Email: sales@peerlesselectric.com, Contact: Paul Petrich.
(See corporate capabilities on page 93)

§ **Penn Iron Works, Inc.**, 700 Old Fritztown Rd., P.O. Box 6858, Wyomissing, PA 19610-6858; Phone: (610) 777-7656 x212, Fax: (610) 777-2327, Http://www.penniron.com, Email: philippides@penniron.com, Contact: S.A. Philippides.
(See corporate capabilities on page 93)

Pentek, Inc., 1026 4th Ave., Coraopolis, PA 15108; Phone: (412) 262-0725, Fax: (412) 262-0731, Http://www.pentekusa.com, Email: pentekusa@aol.com, Contact: Tim Benedict.

- **Performance Contracting Inc. (PCI)**, 16047 W. 110th St., Lenexa, KS 66219; Phone: (913) 928-2800, Fax: (913) 307-0453, Http://www.pciesg.com, Email: esgsales@pcg.com, Contact: Jon Householder.
(See advertisement on page 74)

Plastacor, Inc., P.O. Box 886, McMurray, PA 15317; Phone: (724) 942-0582, Fax: (724) 942-0583, Http://www.plastacor.com, Email: jemplastacor@aol.com, Contact: Jim Mitchell.

Platts UDI, 1200 G St., N. W., Suite 1000, Washington, DC 20005; Phone: (202) 942-8788, Fax: (202) 942-8789, Http://www.udidata.com, Email: udi@platts.com, Contact: Christopher Bergesen.

Plymouth Tube Company Stainless Steel Tubing, 29W150 Warrenville Road, Warrenville, IL 60555; Phone: (630)393-3550, Fax: (918)664-5184, [Http://www.plymouth.com](http://www.plymouth.com), Email: sales@plymouth.com, Contact: Nari Ho.

Power & Energy Systems Services, 880 Ridgewood Ave., Oradell, NJ 07649; Phone: (201) 638-4635, Fax: (201) 265-1516, [Http://www.powerengy.com](http://www.powerengy.com), Email: powerengy@aol.com, Contact: Komandur Sunder Raj.

§ **Powerfect**, 1133 D Industrial Pkwy., Brick, NJ 08724-2582; Phone: (732) 202-1133, Fax: (732) 202-1556, [Http://www.powerfect.com](http://www.powerfect.com), Email: powerfect@verizon.net, Contact: Mary Jane Luddy.
(See corporate capabilities on page 93)

Poyry Energy Ltd. Century House, 100 Station Rd., Horsham, West Sussex RH13 5UZ, UK; Phone: 44(0) 1403 224 200, Fax: 44(0) 1403 224 294, [Http://www.electrowatt-ekono.co.uk](http://www.electrowatt-ekono.co.uk), Email: nuclear@electrowatt-ekono.co.uk, Contact: D. N. Carey.

§ **Precision Custom Components, LLC**, 500 Lincoln St., York, PA 17404; Phone: (717) 848-1126, X2362, Fax: (717) 843-5733, [Http://www.pcc-york.com](http://www.pcc-york.com), Email: jstouch@pcc-york.com, Contact: James C. Stouch.
(See corporate capabilities on page 93)

Preferred Quality Services, Inc., 2707 Dupont Avenue, Jacksonville, FL 32217; Phone: (352) 226-0299, Email: joposton@bellsouth.net, Contact: Johnnie O. Poston.

Pressure Controls, Inc., 406 Cortland Street, Belleville, NJ 07109; Phone: (973) 751-5002, Fax: (973) 751-9653, [Http://pressurecontrols.biz](http://pressurecontrols.biz), Email: pci.paul@verizon.net, Contact: Paul Lind.

Quanta Laboratories, 3199 De La Cruz Blve., Santa Clara, CA 95054; Phone: (408) 988-0770, Fax: (408) 988-0762, [Http://www.quantalabs.com](http://www.quantalabs.com), Email: rgardiner@quantalabs.com, Contact: Robin Gardiner.

R&G Laboratories, Inc., 217 Hobbs Street, suite 105, Tampa, FL 33619; Phone: (813) 643-3513, Fax: (813) 793-4429, [Http://www.randglabs.com](http://www.randglabs.com), Email: chuff97@verizon.net, Contact: Cheryl Huff.

R.O.V. Technologies, Inc., 49 Bennett Drive, Brattleboro, VT 05301; Phone: (802) 254-9353, Fax: (802) 254-9354, [Http://www.rovtech.com](http://www.rovtech.com), Email: mail@rovtech.com, Contact: Jack J. Judge.

§ **RCM Technologies, Inc.**, 2500 McClellan Avenue, Pennsauken, NJ 08109; Phone: (856) 317-0200, x113, Fax: (856) 486-0802, [Http://www.rcmt.com](http://www.rcmt.com), Email: rich.timer@rcmt.com, Contact: Richard Timer.
(See corporate capabilities on page 93)

Red Wolf Associates, 111 Commonwealth Court, Suite 104, Cary, NC 27511; Phone: (919) 467-9686 ext.120, Fax: (919) 465-5991, [Http://www.redwolfassociates.com](http://www.redwolfassociates.com), Email: joe.sinodis@redwolfassociates.com, Contact: Joe Sinodis.

Reef Industries, Inc., 9209 Alameda Genoa, Houston, TX 77075; Phone: (800) 231-6074, Fax: (713) 507-4387, [Http://www.reefindustries.com](http://www.reefindustries.com), Email: tscarborough@reefindustries.com, Contact: Tom Scarborough.

§ **Remote Ocean Systems (ROS)**, 5618 Copley Drive, San Diego, CA 92111; Phone: (858) 565-8500 ext.133, Fax: (858) 565-8808, [Http://www.rosys.com](http://www.rosys.com), Email: sandyk@rosys.com, Contact: Sandy Kennedy.
(See corporate capabilities on page 93)

Research Software Consulting Group, Inc., 9 Irene Court, River Edge, NJ 07661-1115; Phone: (201) 262-3620, Fax: (201) 786-9128, Email: harlan.hurwitz@rscg.com, Contact: Harlan A. Hurwitz.

Rockbestos-Surprenant Cable Corporation, 20 Bradley Park Rd., East Granby, CT 06026; Phone: (860) 653-8300, Fax: (800) 327-7625, [Http://www.r-scc.com](http://www.r-scc.com), Email: steve-sandberg@r-scc.com, Contact: Steve Sandberg.

Rogante Engineering Office, Contrada San Michele, 61, Civitanova Marche, MC 62012 Italy; Phone: (+39) 0733 775248, Fax: (+39) 0733 775248, [Http://www.roganteengineering.it](http://www.roganteengineering.it), Email: info@roganteengineering.it, Contact: Massimo Rogante.

• **Rolls-Royce**, 6546 Pound Rd., Williamson, NY 14589; Phone: (315) 589-4000, Fax: (315) 589-4089, [Http://www.rolls-royce.com](http://www.rolls-royce.com), Email: b.aweir@rolls-royce.com, Contact: Bruce Weir.
(See advertisement on page 49)

S&G Enterprises, Inc., N115 W19000 Edison Dr., Germantown, WI 53022; Phone: (262) 251-8300, Fax: (262) 251-1616, [Http://www.ramflat.com](http://www.ramflat.com), Email: ola@ramflat.com, Contact: O. C. Tyshynsky.

S.M. Stoller Corp., 105 Technology Drive, Suite 190, Broomfield, CO 80021; Phone: (303) 546-4300, Fax: (303) 443-1408, [Http://www.stoller.com](http://www.stoller.com), Email: eolson@stoller.com, Contact: Eric Olson.

Safway Services, LLC, N19 W24200 Riverwood Dr, Waukesha, WI 53188; Phone: (262) 523-6500, Fax: (262) 523-9808, [Http://www.safway.com](http://www.safway.com), Email: darrell.domokos@safway.com, Contact: Darrell Domokos.

SAIC Canada, 60 Queen St., Ste. 1516, Ottawa K1P 5Y7, Ontario Canada; Phone: (613) 563-SAIC, Fax: (613) 563-3399, [Http://www.SAIC.com](http://www.SAIC.com), Email: browng@saiccanada.com, Contact: Glen Brown.

Saint-Gobain Crystals, 17900 Great Lakes Parkway, Hiram, OH 44234; Phone: (440) 834-5600, Fax: (440) 834-7680, [Http://www.detectors.saint-gobain.com](http://www.detectors.saint-gobain.com), Email: scintillation@saint-gobain.com, Contact: Kim Blackmon.

§ **Sargent & Lundy**, 55 E. Monroe St., Chicago, IL 60603; Phone: (312) 269-2000, Fax: (312) 269-3680, [Http://www.sargentlundy.com](http://www.sargentlundy.com), Email: robert.d.schuetz@sargentlundy.com, Contact: Bob Schuetz.
(See corporate capabilities on page 93)

• **Schulz Electric Company**, 30 Gando Dr., New Haven, CT 06513; Phone: (203) 562-5811, Fax: (203) 562-1082, [Http://www.schulzelectric.com](http://www.schulzelectric.com), Email: matr@schulzelectric.com, Contact: Matt Radulski.
(See advertisement on page 57)

• § **Scientech, a business unit of Curtiss-Wright Flow Control Company**, 200 South Woodruff Ave, Idaho Falls, ID 83401; Phone: (301) 668-1033, Fax: (301) 682-9209, [Http://scientech.cwfc.com](http://scientech.cwfc.com), Email: dmurphy@curtisswright.com, Contact: Donald Murphy.
(See advertisement on page 69)
(See corporate capabilities on page 94)

S-E International, Inc., 436 Farm Rd, P.O. Box 39, Summertown, TN 38483-0039; Phone: (931) 964-3561, Fax: (931) 964-3564, [Http://www.seintl.com](http://www.seintl.com), Email: radiationinfo@seintl.com, Contact: Corey Walker.

Seafab Metal Company, 1112 N. VIP Blvd., Casa Grande, AZ 85122; Phone: (800)426-7082, Fax: (520)421-3222, [Http://Seafab.com](http://Seafab.com), Email: ttcline@seafab.com, Contact: Ted Cline.

• § **Seal Master Corporation**, 368 Martinel Dr., Kent, OH 44240; Phone: (800) 477-8436, Fax: (330) 673-8242, [Http://www.sealmaster.com](http://www.sealmaster.com), Email: info@sealmaster.com, Contact: Thomas Hillery.

(See advertisement on page 69)
(See corporate capabilities on page 95)

Sentry Equipment Corp, 966 Blue Ribbon Circle N, Oconomowoc, WI 53066; Fax: (262)567-4523, [Http://www.sentry-equip.com](http://www.sentry-equip.com), Email: sales@sentry-equip.com, Contact: Rob Lemke.

• **Siempelkamp Nukleartechnik GmbH**, Siempelkampstrasse 45, Krefeld NRW 47803, Germany; Phone: 49 2151 894 488, Fax: 49 2151 894 488, [Http://www.siempelkamp.com](http://www.siempelkamp.com), Email: snt.krefeld@siempelkamp.com, Contact: Christian Jurianz.
(See advertisement on page 31)

SKODA JS a.s., Orlik 266, 316 06 Plzen, Czech Republic; Phone: 420 378 042 410, Fax: 420 377 520 600, Http://www.skoda-js.cz, Email: josef.riha@skoda-js.cz, Contact: Josef Riha.

Southwest Research Institute, 6220 Culebra Rd., P.O. Drawer 28510, San Antonio, TX 78228-0510; Phone: (210) 522-5242, Fax: (210) 522-4748, Http://www.failureanalysis.swri.org., Email: Kbennett@swri.org, Contact: Kenneth H. Bennett.

Spectra Physics Hilger Crystals Limited, Westwood Estate, Margate, Kent CT9 4JL, United Kingdom; Phone: (44)1843 231166, Fax: (44)1843 290310, Http://www.hilger-crystals.co.uk, Email: sales@hilger-crystals.co.uk, Contact: J. R. Telfer.

- § **SSM Industries, Inc.**, 3401 Grand Ave., Pittsburgh, PA 15225-1507; Phone: (412) 777-5101 X-363, Fax: (412) 771-5382, Email: m.saucier@ssmi.biz, Contact: Mark Saucier.
(See advertisement on page 46)
(See corporate capabilities on page 95)

Standish Technologies, International, 1005 Ashby C, Deerfield Beach, FL 33442; Phone: (786)664-6776, Fax: (954)697-0311, Http://www.standtech.com, Email: neilp@standtech.com, Contact: Neil Passman.

Staplex-Air Sampler Division, 777 5th Ave., Brooklyn, NY 11232-1626; Phone: (800) 221-0822, Fax: (718) 965-0750, Http://www.staplex.com, Email: info@staplex.com, Contact: Doug Butler.

STAUBLI Corporation, 201 PARway West, Dncan, SC 29334; Phone: (864)486-5472, Fax: (864)486-5495, Http://www.staubli.us, Email: c.eason@staubli.com, Contact: Chris Eason.

Steel Dynamics Roanoke Bar Division, 102 Westside Blvd, Roanoke, VA 24038; Phone: (800) 753-3532, Fax: (840) 342-6610, Http://www.steeldynamics.com, Email: sales@roanokesteel.com, Contact: Parker Arthur.

Steventon Stewart International Inc., 13 Sauble Drive, Ottawa, Ontario K2M2Y3; Phone: (613) 591-5657, Http://www.stewartandstevenson.com, Email: jeffrey.norton@live.ca, Contact: Jeffrey Norton.

Stork H&E Turbo Blading, 334 Comfort Rd., Ithaca, NY 14850; Phone: (607) 277-4968 x292, Fax: (607) 277-1193, Http://www.he-machinery.com, Email: joe.walker@storkhe.com, Contact: Joe Walker.

Streicker & Company Inc., 37 Eastern Ave, East Providence, RI 02914; Phone: (401) 435-0200, Fax: (401) 751-1555, Http://www.streicker.com, Email: advertise@streicker.com, Contact: Paul Streicker.

- **Structural Integrity Associates, Inc.**, 11515 Vanstory Dr. Ste 125, Huntersville, NC 28078; Phone: (704) 977-2332, Fax: (704) 597-0335, Http://www.structint.com, Email: vdouglass@structint.com, Contact: Vicki Douglass.
(See advertisement on page 78)

Studsvik, Inc, 5605 Glenridge Dr., Suite 705, Atlanta, GA 30342; Phone: (404) 497-4905, Fax: (404) 497-4901, Http://www.studsvik.com, Email: steven.jameson@studsvik.com, Contact: Steven Jameson.

Superbolt Inc., 1000 Gregg Street, Carnegie, PA 15106; Phone: (412) 279-1149, Fax: (412) 279-1185, Http://www.superbolt.com, Email: jmilburn@superbolt.com, Contact: Jason Milburn.

TECH Products, Inc., 105 Willow Ave., Staten Island, NY 10305; Phone: (718) 442-4900, Fax: (718) 442-2124, Email: doconnor@techproducts.com, Contact: Daniel D O'Connor.

Technisonic Research Inc., 328 Commerce Dr., Fairfield, CT 06825; Phone: (203) 368-3600, Fax: (203) 368-1922, Http://www.technisonic.com, Email: tonyr@technisonic.net, Contact: Tony Ruiz.

- § **Technology for Energy Corporation (TEC)**, 10737 Lexington Dr., Knoxville, TN 37932-3294; Phone: (865) 966-5856, Fax: (865) 675-1241, Http://www.tecnuclear.com, Email: sales@tecnuclear.com, Contact: Sarah Robertson.
(See advertisement on page 85)
(See corporate capabilities on page 95)

- **Tecnatom, S.A.**, Avenue Montes de Oca 1, 28703 San Sebastian de los Reyes, Madrid Spain; Phone: (34) 91 6598600, Fax: (34) 91 6598677, Http://www.tecnatom.es, Email: correo@tecnatom.es, Contact: Juan Ortega.
(See advertisement on page 70)

Teledyne Brown Engineering, Inc., 300 Sparkman Drive, Huntsville, AL 35805; Phone: (256) 726-1385, Http://www.teledyne.nuclear.com or http://tbe.com, Email: jessica.sanders@tbe.com, Contact: Jessica Sanders.

Temp-Pro Inc., 200 Industrial Dr., Northhampton, MA 01060; Phone: (413) 584-3165, Fax: (413) 586-3625, Http://www.temp-pro.com, Email: stanley.grip@temp-pro.com, Contact: Stanley T. Grip.

- § **The Delphi Groupe, Inc.**, 2211 S. IH-35, Ste. 400, Austin, TX 78741; Phone: (512) 462-1181, Fax: (512) 462-1187, Http://www.delphigroupe.com, Email: mrandolph@delphigroupe.com, Contact: Mark Randolph.
(See corporate capabilities on page 95)

The Macris Group, P.O. Box 535, Mystic, CT 06355; Phone: (860) 572-0043, Fax: (860) 572-0043, Http://www.themacrisgroup.com, Email: acmpc@acmacris.com, Contact: A.C. Macris.

- **The Shaw Group**, 128 South Tryon St., Suite 600, Charlotte, NC 28202; Phone: (704)343-7500, Http://www.shawgrp.com.
(See advertisement on page 61)

Thermal Engineering International (USA), 10375 Slusher Drive, Santa Fe Springs, CA 90670; Phone: (323) 838-1132, Fax: (323) 838-6454, Http://www.thermalengint.com, Email: msr@thermalengint.com, Contact: Abraham L. Yarden.

- § **Thermo Scientific, NFMS Part of Thermo Fisher Scientific**, 10010 Mesa Rim Rd., San Diego, CA 92121; Phone: (800) 488-4399, Fax: (858) 452-9250, Http://www.thermoscientific.com/nuclear, Email: ussdi.customersupport@thermofisher.com, Contact: Clark Artaud.
(See corporate capabilities on page 96)

- § **Thermo Scientific-CIDTEC (Part of Thermo Fisher Scientific)**, 101 Commerce Blvd., Liverpool, NY 13088; Phone: (315) 451-9410, Fax: (315) 451-9421, Http://www.thermo.com/cidtec, Email: tony.chapman@thermofisher.com, Contact: Tony Chapman.
(See advertisement on page 77)
(See corporate capabilities on page 96)

Theseus Professional Services, LLC, 2380 Moreau Drive, Westminster, MD 21158; Phone: (410) 857-0023, Fax: (410) 857-2391, Http://www.theseuspro.com, Email: nmoreau@theseuspro.com, Contact: Norman P. Moreau.

- § **Tioga Pipe Supply Company Inc.**, 2450 Wheatsheaf Ln., Philadelphia, PA 19137; Phone: (215) 831-0700, Fax: (215) 533-1645, Http://www.tiogapipe.com, Email: jshaw@tiogapipe.com, Contact: Jeff Shaw.
(See corporate capabilities on page 96)

- **TPC Wire & Cable Corp.**, 9600 Valley View Road, Macedonia, OH 44056; Phone: (216)525-4447, Fax: (866)528-2930, Http://www.tpcwire.com, Email: jhathaway@tpcwire.com, Contact: Jay Hathaway.
(See advertisement on page 15)

Transco Products Inc., 55 E. Jackson Blvd., Ste. 2100, Chicago, IL 60604; Phone: (312) 427-2818, Fax: (312) 427-4975, Http://www.transcoproducts.com, Email: info@transcoproducts.com, Contact: Nathan Miller.

TransWare Enterprises Inc., 1565 Mediterranean Dr., Sycamore, IL 60178-3141; Phone: (815) 895-4700, Fax: (815) 895-4704, Http://www.transware.net, Email: vjones@TRANSWARE.NET, Contact: Virginia Jones.

Tri Nuclear Corporation, 40 Lake Rd., P.O. Box 1130, Ballston Lake, NY 12019; Phone: (518) 399-1389, Fax: (518) 399-9586, [Http://www.trinuclear.com](http://www.trinuclear.com), Email: jwarden@trinuclear.com, Contact: James Warden.

- **Tri Tool Inc.**, 3041 Sunrise Blvd., Rancho Cordova, CA 95742; Phone: (916) 288-6100, Fax: (916) 288-6160, [Http://www.tritool.com](http://www.tritool.com), Email: customer.service@tritool.com, Contact: Bill Atkinson.
(See advertisement on page 62)
- **Trust Manufacturing**, 20080 St. Clair, Cleveland, OH 44117; Phone: (216) 531-8787, Fax: (216) 531-8778, [Http://www.trustmfg.com](http://www.trustmfg.com), Email: edgills@trustmfg.com, Contact: Ed Gills.
(See advertisement on page 40)
- § **TW Metals - Nuclear Materials Solutions**, 880 Brickworks Drive, Leetsdale, PA 15056; Phone: (724) 251-4700, Fax: (724) 251-4701, [Http://www.twmetals.com](http://www.twmetals.com), Email: franz.schmidt@twmetals.com, Contact: Franz Schmidt.
(See advertisement on page 55)
(See corporate capabilities on page 96)
- Ultimate Power Solutions**, 9921 Carmel Mountain Rd.#133, San Diego, CA 92129; Phone: 858/793-4544, Fax: 858/793-4544, [Http://www.ultimatepowersolutions.com](http://www.ultimatepowersolutions.com), Email: rob@ultimatepowersolutions.com, Contact: Rob Parrish.
- § **Underwater Construction Corporation**, 110 Plains Rd., Essex, CT 06426; Phone: (860) 575-0488, Fax: (860) 767-0612, [Http://www.uccdiv.com](http://www.uccdiv.com), Email: pmcdermott@uccdiv.com, Contact: Philip G Mcdermott.
(See corporate capabilities on page 96)
- § **UniTech Services Group, Inc. Div. of Unifirst Corp.**, 295 Parker St., P.O. Box 51957, Springfield, MA 01151; Phone: (413) 543-6911, X16, Fax: (413) 543-2975, [Http://www.UniTechUS.com](http://www.UniTechUS.com), Email: gjohnstone@UniTechUS.com, Contact: Steve Hofstatter.
(See advertisements on page 18 and 32)
(See corporate capabilities on page 97)
- **URENCO Ltd.**, URENCO Court, Sefton Park, Stoke Poges, Bucks, SL2 4JS UK; Phone: (44) 1753 660 660, Fax: (44) 1753 660 774, [Http://www.urenco.com](http://www.urenco.com), Email: enquiries@urenco.com, Contact: Paul Harding.
(See advertisement on page 39)
- URS Corporation**, 510 Carnegie Center, P.O. Box 5287, Princeton, NJ 08543; Phone: (609) 720-2000, Fax: (609) 720-2050, [Http://www.urscorp.com](http://www.urscorp.com), Email: Arthur.lembo@urs.com, Contact: Kate Antolick.
- § **Uticom Systems Inc.**, 109 Independence way, Coatesville, PA 19320; Phone: (610) 857-2986, Fax: (610) 857-2986, Email: jennifer@uticom.net, Contact: Jennifer Martin.
(See corporate capabilities on page 97)

Utility Resource Associates, 2275 Research Blve., Suite 500, Rockville, MD 20850; Phone: (301) 294-0866, Fax: (301) 294-7879, [Http://www.urac.com](http://www.urac.com), Email: rlgrow@urac.com, Contact: Rodney L. Grow.

- § **Valcor Engineering Corporation**, 2 Lawrence Rd., Springfield, NJ 07081; Phone: (973) 467-8480 EXT 7226, Fax: (973) 467-3365, [Http://www.valcor.com](http://www.valcor.com), Email: stevegatcomb@valcor.com, Contact: Steve Gatcomb.
(See corporate capabilities on page 97)
- VAT, INC.**, 500 West Cummings Park, Ste 5450, Woburn, MA 01801; Phone: (781) 537-5410, [Http://www.vatvalve.com](http://www.vatvalve.com), Email: joycem@vatvalve.com, Contact: Joyce Mackiewicz.
- Velan Inc.**, 7007 Cote de Liesse, Montreal H4T 1G2, Quebec Canada; Phone: (514) 748-7743, Fax: (514) 748-8635, [Http://www.velan.com](http://www.velan.com), Email: christian.schweiger@velan.com, Contact: Christian Schweiger.
- Veridium**, P.O. Box 609036, San Diego, CA 92160-9036; Phone: (619) 448-1000, Fax: (619) 562-5776, [Http://www.veridium.com](http://www.veridium.com), Email: rhockman@veridium.com, Contact: Rich Hockman.
- VGSSolutions**, 3174 Plum Tree Crescent, Mississauga, Ontario L5N 4X3 Canada; Phone: (905) 824-6236, Email: vgssolutions@rogers.com, Contact: Victor G. Snell.
- Volian Enterprises, Inc.**, P.O. Box 410, Murrysville, PA 15668; Phone: (724) 335-3744, Fax: (724) 337-9752, [Http://www.volian.com](http://www.volian.com), Email: volianenterprises@volian.com, Contact: Harold Julian.
- VTT Technical Research Centre of Finland**, Tietotie 3, Espoo, P.O. Box 1000, FI-02044 VTT, Finland; Phone: 358 20 722 5031, Fax: 358 20 722 5000, [Http://www.vtt.fi/nuclear](http://www.vtt.fi/nuclear), Email: ilona.lindholm@vtt.fi, Contact: Ilona Lindholm.
- Walischmiller Engineering GmbH**, Schiessstattweg 16, Markdorf, 88677 Germany Phone: (49) 7544 9514 0, Fax: (49) 7544 9514 99, Email: info@hwm.com, Contact: Claudia Reich.
- Waste Control Systems, Inc.**, 2835 Merrymans Mill Rd., Phoenix, MD 21131-1631; Phone: (410) 252-9360, Fax: (410) 252-9362, [Http://www.wastecontrol.com](http://www.wastecontrol.com), Email: sales@wastecontrol.com, Contact: William Fannon.
- Weed Instrument Co., Inc d/b/a Ultra Electronics, NSPI**, 707 Jeffrey Way, P.O. Box 300, Round Rock, TX 78680; Phone: (512) 434-2950, Fax: (512) 434-2951, [Http://www.weedinstrument.com](http://www.weedinstrument.com), Email: nuclear@weedinstrument.com, Contact: David Robertson.

- **Weldstar**, 1750 Mitchell Road, Aurora, IL 60542; Phone: (630) 859-3100, Fax: (630) 859-3199, [Http://www.weldstar.com](http://www.weldstar.com), Email: bdecker@weldstar.com, Contact: Bob Decker.
(See advertisement on page 84)
- § **Westerman Nuclear**, 245 N. Broad St., Bremen, OH 43107; Phone: (800) 338-8265, Fax: (740) 569-4111, [Http://www.westermancompanies.com](http://www.westermancompanies.com), Email: bmoore@westermancompanies.com, Contact: William Moore.
(See advertisement on page 75)
(See corporate capabilities on page 97)
- Western United Industries**, P.O. Box 2008, Toluca Lake, CA 91610; Phone: (818) 980-9977, Fax: (818) 980-2618, Contact: Barry Tindell.
- § **Westinghouse Electric Company**, 1000 Westinghouse Drive, Cranberry Township, PA 16066; Phone: (412) 374-6737, Fax: (724) 940-8518, Email: shawsa@westinghouse.com, Contact: Scott Shaw.
(See advertisement on page 115)
(See corporate capabilities on page 97)
- WITTENSTEIN**, 1249 Humbracht Circle, Bartlett, IL 60103; Phone: (630) 540-5300, Fax: (630) 736-6100, [Http://www.wittenstein-us.com](http://www.wittenstein-us.com), Email: info@wittenstein-us.com, Contact: Robert Brennan.
- WM Symposia Ste 9-332**, 1628 E Southern Ave, Suite 9-322, Tempe, AZ 85282; Phone: (520) 696-0399, Fax: (520) 829-3550, [Http://www.wmsym.org](http://www.wmsym.org), Email: mary@wmarizona.org, Contact: Mary Young.
- § **WMG, Inc.**, 16 Bank St., Peekskill, NY 10566; Phone: (914) 736-7100, Fax: (914) 736-7170, [Http://www.wmginc.com](http://www.wmginc.com), Email: tduberville@wmginc.com, Contact: Thomas Duberville.
(See corporate capabilities on page 97)
- Wolfco, Inc.**, 204 S. Willard Street, Burlington, VT 05401; Phone: (802)859-9890, Fax: (802)859-9888, Email: wolfco@erols.com, Contact: Walt H. Wolf.
- WorleyParsons Polestar**, 601 Williams Blvd. ste 4A, Richland, WA 99354; Phone: (509) 946-8279, Fax: (509) 946-8889, [Http://www.worleyparsons.com](http://www.worleyparsons.com), Email: jodi.mix@WorleyParsons.com, Contact: Jodi Mix.
- § **Wyle Laboratories, Inc.**, 7800 Hwy. 20 W, Huntsville, AL 35806; Phone: (256) 716-4283, Fax: (256) 837-3363, [Http://www.wyle.com](http://www.wyle.com), Email: greg.mason@wyle.com, Contact: Greg Mason.
(See corporate capabilities on page 98)
- § **Zachry Nuclear Engineering, Inc**, 14 Lords Hill Road, Stonington, CT 06348; Phone: (860) 405-3054, Fax: (860) 446-8292, [Http://www.zhi.com](http://www.zhi.com), Email: ApicelliL@zhi.com, Contact: Lisa Apicelli.
(See advertisement on page 11)
(See corporate capabilities on page 98) ■

Nuclear Plant Journal Benefits of Advertising

- Cost-free, digital versions of Nuclear Plant Journal link your ads' and press releases' emails and URLs directly to your customers
- Free editorial participation in the Journal with contact's email and phone listing
- The highest BPA audited circulation with over 12,000 digital and hard-copy readers
- Your organization's URL listed in Journal's Web Directory

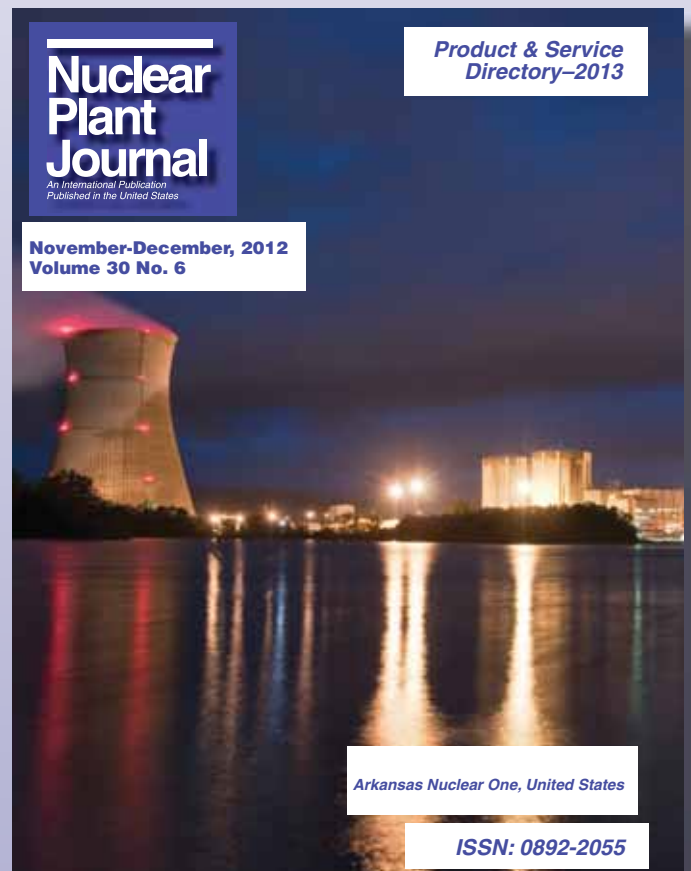

For additional details, please contact
Michelle Gaylord via telephone at (630) 313-6739
or email michelle@goinfo.com. You may also visit:

nuclearplantjournal.com

An Industry Frontrunner

By Donna Gregory, Entergy Nuclear.

Donna Gregory

Donna Gregory is a senior communications specialist with over 27 years of experience in the nuclear industry beginning with Entergy in 1985 at Arkansas Nuclear One. Prior to her communications position, Gregory worked in planning, scheduling and outages department; multi-media; and in Entergy's Continuous Improvement program.

Gregory has a bachelor's degree in journalism from Arkansas Tech University and a master's degree in operations management from the University of Arkansas at Fayetteville.



Leading in the Arkansas River Valley

Arkansas Nuclear One (ANO) is a two-reactor site located in Russellville, Arkansas. On December 19, 1974, ANO, Unit 1 began commercial operations and less than six years later, on March 26, 1980, the ANO, Unit 2 began generating electricity for the state of Arkansas. Together, the plants supply 1,823 megawatts of power, which is equal to approximately 25 percent of the total energy demand of the state.

In 1974, local newspaper reports recalled that the decision to build the two-unit nuclear plant near Russellville was the “greatest thing in the Arkansas River Valley.” Arkansas Nuclear One provides jobs to more than 1000 people in the River Valley area. In 2009, ANO celebrated 35 years of providing safe, reliable and affordable power to the people of Arkansas.

Quick Facts:

ANO, Unit 1 is a pressurized water reactor, Babcock and Wilcox, producing 836 megawatts. The ANO Unit 1 license expiration date is May 20, 2034.

ANO, Unit 2 is a pressurized water reactor, Combustion Engineering, producing 987 megawatts. The ANO Unit 2 expiration date is July 17, 2038.

ANO employs approximately 950 people. During 2011, environmental emissions avoided due to nuclear power plant operation in Arkansas included 16,000 tons of sulfur dioxide, 10,000 tons of nitrogen oxide and 10 million metric tons of CO₂.

Notables at a Glance

In 2001, the NRC granted a 20-year license renewal to Arkansas Nuclear One, Unit 1, positioning Entergy as an industry frontrunner in license renewal and setting the pace for additional renewal efforts. The expiration date is May 2034.

The ANO, Unit 1 license renewal application took the NRC less than 17 months to review and approve, the shortest time of any review to date. Entergy, as an industry leader in license renewal processes, offering services to the nuclear industry with an expert national licensing team in Arkansas.

In 2003, ANO, Unit 2's refueling outage was the quickest in the site's history and a world record for nuclear reactors of that design.

In June 2005 Entergy received the 20-year license renewal to ANO, Unit 2. The expiration date is July 2038.

2011 saw a record performance: ANO, Unit 1 completed its longest run ever at 538 days of being online, producing electricity.

One of Entergy's core values is a commitment to help the communities we serve, and ANO employees maintain a strong presence in Russellville and the surrounding Arkansas River Valley area. Currently, ANO employees and retirees are heavily involved in building the first Habitat for Humanity home in the River Valley Area. The 2012 Boy Scout Merit Badge University at ANO left little doubt that the annual event has become a state-wide favorite. Scheduled to coincide each year with National Engineer Week, attendance exceeded 250, the largest since the University was launched in 2004. Other major community initiatives include ValleyFest which supports Boys & Girls Clubs, the River Valley Arts Center, Community Scholarship Fund, quarterly Red Cross blood drives and River Valley Heart Walk. The employees at ANO had another successful United Way campaign surpassing their goal and raising \$100,617. This amount is matched dollar-for-dollar by Entergy making the total contribution to the Russellville United Way over \$201,000.

Leading the Nuclear Industry

In 2010 Arkansas Nuclear One received “Nuclear Project of the Year” honors from Power Engineering for their industry innovation, “Next Generation Tungsten Shielding and Tungsten Vest.” Made with a flexible polymer immersed with tungsten, the shielding has magnets

(Continued on page 114)

Banner Advertising Special Offer



**Nuclear
Plant
Journal**
An International Publication
Published in the United States

- 20% discount for all banner advertising (available for print issue advertisers)
- Banner ads are \$2,700 for six months and \$4,500 for the whole year.

For questions, please contact Michelle Gaylord,
michelle@goinfo.com, (630) 364-4780.

An Industry...

Continued from page 112

embedded in the various sheet sizes so as to “snap-and-shield” around pipes or to other surfaces such as bridge flooring. It is more effective than lead, can be easily cut in the field to fit as needed and even comes as tungsten duct tape for small, varying needs. Coupled with this innovation was the creation of a tungsten vest that shields the worker (rather than just shielding the source) for the first time ever in the industry with Nuclear Regulatory Commission approvals.

For this innovation ANO also received the American Nuclear Society 2011 Meritorious Performance in Operations Award, the Top Industry Practice Award given by the Nuclear Energy Institute and recognition as a 2011 FINALIST in the Platts Global Energy Awards.

In 2012 ANO also was honored by NEI with a Top Industry Practice award in plant support for “Angel Wings,” a portable, lightweight structure that replaces costly scaffolding for welding and other jobs.

In total, ANO has won eight Top Industry Practice awards since 1999 when NEI recognized ANO with the “Best of the Best” award that year for “Risk-Informed In-Service Inspection Program for Piping Welds.”

Operational Safety and Continuous Improvement

The ANO mission is to be an industry leader in all areas of safety and plant performance with a commitment to continuous improvement, a hallmark of their employees. ANO is on a journey to take the plant to new levels of performance by concentrating efforts on areas they have identified as essential to their success signified by the acronym HERO: Human performance, Equipment reliability, Refueling outage performance and Organizational effectiveness.

“A special and unique industry requires special and unique people to operate it safely and successfully. This

is how I would describe our workforce at Arkansas Nuclear One,” said site Vice President Chris Schwarz. “Our focus is on developing ANO leaders by partnering with the Leadership Development Institute at Eckerd College coupled with performance management training to strengthen our skills, to improve operational focus and, of course, to result in overall plant performance excellence. These initiatives are closing the gaps from ‘good to great’ for both of our units.”

The Occupational Safety and Health Administration acknowledge Arkansas Nuclear One as a 15-year participant at the Star level in the Voluntary Protection Program, VPP which is the most prestigious workplace safety and health recognition program in the United States. In 1996, Arkansas Nuclear One joined the VPP at the Star level, becoming the first nuclear site to be accepted into the program.

ANO since Fukushima

Over the past year, Entergy has taken a leading role in assisting the understanding and response to the events at Fukushima at an industry level. In addition to sharing our technical expertise with the industry to compile and review safety capabilities of certain U.S. plant designs, all Entergy plants – including Arkansas Nuclear One – have undergone extensive walk-downs and procedure reviews that validate our ability to respond during a disaster.

To further strengthen their emergency capabilities, all Entergy Nuclear plants are ordering new equipment in 2012, including additional diesel driven pumps, portable diesel generator sets, portable ventilation equipment, communications tools and other equipment.

Contact: Donna Gregory, telephone: (479) 858-4861, email: dgregor@entergy.com. ■

Chris Schwarz

Chris Schwarz was named site vice president of Arkansas Nuclear One in December 2010. Before coming to ANO, Schwarz was site vice president of Palisades Power Plant in Covert, Michigan from February 2007 until December 2010.



Schwarz had served as Vice President of Operations Support for Entergy Nuclear Northeast from June 2005 until February 2007. In this role, he was responsible for support organizations that included licensing, information technology, corporate quality assurance, materials, purchasing and contracts, planning, scheduling and outages and training.

Before joining Entergy, Schwarz worked at Millstone Station as Station Director of Operations and held various other leadership positions in work management, operations and training. Prior to Millstone, he worked for the Institute of Nuclear Power Operations and provided leadership as shift manager at the Peach Bottom Atomic Power Station.

Serving in the United States Navy as Engineering Watch Supervisor, U.S.S. Lafayette SSBN 616, Schwarz received a Navy Achievement Medal for leadership and professional achievement.

Schwarz received his bachelor's degree in engineering from Widener University in Philadelphia, Penn. He held a senior reactor operator license earned at Peach Bottom and two certifications; NRC SRO Certification and GE SRO Certification, BWR 6, Perry Simulator.

ONE SMALL WESTINGHOUSE REACTOR

Another giant step by the true leader in commercial nuclear energy



WESTINGHOUSE ELECTRIC COMPANY LLC

Westinghouse, the world leader in the development, licensing and deployment of commercial nuclear energy plants, is again leading the industry, this time with a 225 MWe integrated pressurized water reactor that can generate electricity for a residential community of 180,000 homes without emitting any greenhouse gases.

And unlike other designs, the Westinghouse Small Modular Reactor (SMR) is an outgrowth of proven, land-based nuclear reactor technology that takes safety, reliability and constructability to unsurpassed levels.

To make this exciting new reactor a reality, Westinghouse, with the full support and backing of its majority owner Toshiba Corporation, is working with a distinguished group of partners, notably Ameren Missouri, the Association of Missouri Electric Cooperatives, Associated Electric Cooperative, Inc., The Empire District Electric Company, Kansas City Power & Light Company and the Missouri Public Utility Alliance.

Proud of our track record of success, but always looking to the future, Westinghouse nuclear technology will help provide future generations with safe, clean and reliable electricity.

Check us out at www.westinghousenuclear.com



Westinghouse

A Toshiba Group Company

You can be sure...
if it's Westinghouse

Follow the leader.

Pop-A-Plug[®], the industry's most advanced technology for sealing leaking heat exchanger tubes.



A proven long-term performer in nuclear plants, Pop-A-Plug Heat Exchanger Tube Plugging System reduces downtime, eliminates welding and explosives, and will not damage your tubes, tube joints or tubesheet. Manufactured to ANSI N45.2, 10CFR50 Appendix B, the Pop-A-Plug System features patented, internally serrated rings designed to maintain a leak-tight seal under extreme thermal and pressure cycling. Fast, safe, and effective — just “Set 'Em and Forget 'Em.”

**CURTISS
WRIGHT**
Flow Control Company
EST Group